



MANN+HUMMEL  
Air Cleaners

With interactive  
register and contents

# MANN+HUMMEL

## Leadership in Filtration



**MANN+HUMMEL is a leading global expert for filtration solutions. The company group with its headquarters in Ludwigsburg, Germany, develops solutions for motor cars, industrial applications, clean air in interior spaces and the sustainable use of water. In 2018, more than 20,000 employees were employed globally by the group at more than 80 locations. The products manufactured by the group include air cleaner systems, intake manifold systems, liquid filter systems, plastic components, filter media, cabin air filters, industrial filters and membrane filters.**

High-quality filtration products for vehicles, engines and industrial applications are a key area. The original equipment business with leading global vehicle, machine and plant manufacturers forms the basis for the quality and performance of our products. Spare parts are sold under numerous world-famous customer brands as well as under the company's own MANN-FILTER brand.

The product range described in this catalog was developed especially for special customer requirements in the areas of off-highway, vehicle and engine engineering, compressed air and vacuum technology, machinery and mechanical engineering. MANN+HUMMEL offers high-performance products for these and other industrial fields in the area of filtration and separation of air, gases and liquids.

### **Important note for our customers**

We are continually developing our product range in order to make our high-performance and economical filtration products even better. For this reason, we expressly reserve the right to change our products and delivery program after this catalog has been published. This includes technical changes and also the discontinuation of products, in particular for older products. Information on changes and general availability can be obtained from your MANN+HUMMEL contact person.

**Page 4 - INTRO**

Company profile, contents, product overview

**Page 12 - IQORON SERIES**

IQORON, IQORON-V, IQORON-S,  
IQORON VP

**Page 42 - ENTARON SERIES**

ENTARON XD/MD,  
ENTARON HD/CD

**Page 68 - NLG SERIES**

NLG Pico, NLG Piclon, DualSpin combination air cleaners

**Page 90 - EUROPICLON**

**Page 104 - PICLON**

**Page 114 - PICOLINO**

Intake air cleaners, silencer air cleaners

**Page 120 - PICOLIGHT**

**Page 124 - VACUUM AIR CLEANERS**

**Page 128 - SPECIAL AIR CLEANERS**

Air cleaners for two-way ventilation, silencer air cleaners

**Page 132 - ACCESSORIES**

Rain caps, pre-cleaner dust bowls, air connecting parts,  
service switches / indicators

**Page 150 - APPENDIX**

Filter glossary, design criteria, determination of the dust capacity,  
general instructions for installation and service, conversion table

# MANN+HUMMEL

## Competence in detail

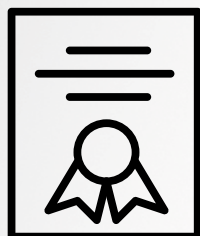

### EXCELLENT QUALITY

Our air cleaners are used every day in various applications, under conditions ranging from low to high dust loads. Modern, high-performance applications such as construction and agricultural machinery, compressors, commercial and special vehicles, engines and gearboxes have to withstand extreme challenges. The use of inferior filters in these applications leads to above average wear. Using high quality filters from MANN+HUMMEL - which are easy to service - you can rely on maximum performance and minimum wear even under toughest conditions. This is because our products meet the highest requirements and are subject to most severe durability tests. With every service, you benefit from a quality standard that meets the original equipment manufacturer level.

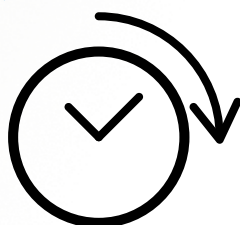

### PROVEN RELIABILITY

Our products separate the useful from the harmful. Nothing is more important to us than the reliability of your capital goods. In daily operation, reliability and continuity are essential - in other words, components which are ready for operation at any time to ensure the correct function of the machines. The high separation efficiency of our filters enhances the protection of your engines. This has a positive effect on the service interval and operating hours. High-performance products which are easy to service help to avoid expensive repairs. As a result, you simultaneously increase the economic efficiency and sustainability of your investment and therefore reduce the total cost of ownership. Our certified development processes and standardized testing procedures ensure the function of the products in all situations.



### INNOVATIVE TECHNOLOGY

MANN+HUMMEL filters represent the state of the art and utilize continuous improvement processes. Innovative developments such as VarioPleat meet the challenges of the market, whereby the power density of the products increases and a higher filtration performance is realized in a smaller installation space. Digital transformation is nothing new for us. At MANN+HUMMEL filtration and digitalization go hand in hand. This is because the future is digital - also at our company. We combine intelligent technology with our filtration expertise. Our experts are available at any time to assist you with this step.

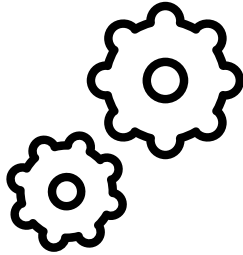

### **DEVELOPMENT EXPERTISE**

Research and development is a top priority for us. Our daily work is focused on the wishes and requirements of our customers. In our international R&D and production network we are constantly expanding our products and areas of expertise. Our air cleaners are robust, high-performance systems which are designed to meet varied requirements in the fields of production, transport, trades, construction and agriculture. Here we offer customers solutions based on modular products as well as individual solutions tailored to specific applications and cover the entire range as a development partner - from the development of media to the provision of comprehensive system expertise.



### **FULL SERVICE**

MANN+HUMMEL offers an extensive product range for all types of commercial vehicles and industrial applications. Depending on the field of application and type of drive, different filter elements are used. The company offers solutions for combustion engines, fuel cells, electric vehicles, air conditioning and ventilation systems in mobile applications. In addition, our experts provide extensive consultation to enable a reliable service. This saves time and money and also ensures a constant level of service and quality.

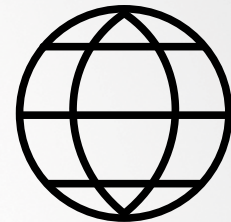

### **GLOBAL SALES NETWORK**

Our air cleaners are in global use and therefore require an area-wide service structure. The global sales network of MANN+HUMMEL ensures that the required filter elements are available anywhere, anytime. You benefit from our quick and reliable distributor and partner network almost all over the world.

# Air cleaners

## Product overview

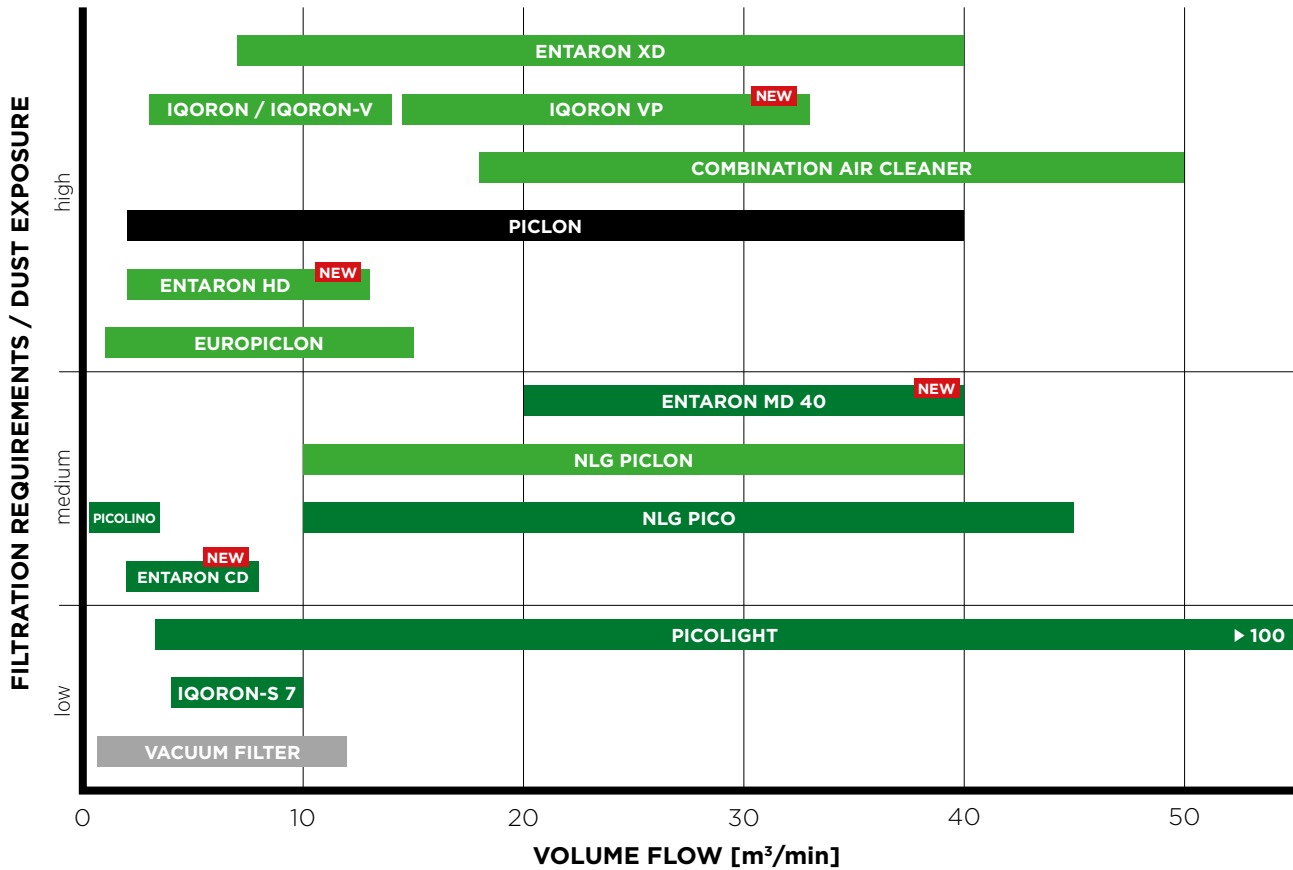

- Single-stage metal filter
- Single-stage plastic filter
- Two-stage metal filter
- Two-stage plastic filter



Unless otherwise stated, all filtration data (e.g. pre-separation efficiency, flow characteristics, etc.) are measured using ISO test dust 12103-1 A4 (ISO coarse) according to ISO 5011.

# Air cleaners

## Product overview

PAGE 18



### IQORON – Two-stage plastic air cleaner

<b>Volume flow range</b>	4 m <sup>3</sup> /min to 12 m <sup>3</sup> /min
<b>Operating temperature</b>	Continuous: -30 °C to +100 °C / Short-term: +120 °C
<b>Pre-separation</b>	Multi-cyclone block
<b>Main element</b>	CompacPleat element with double bellow technology, axial seal, metal-free
<b>Secondary element</b>	Pleated paper element, metal-free
<b>Selection criteria</b>	High power density, compact design and long service life, scavenging required
<b>Typical applications</b>	Construction and agricultural machines, mining operations, etc.

PAGE 22



### IQORON-V – Two-stage plastic air cleaner

<b>Volume flow range</b>	3 m <sup>3</sup> /min to 14 m <sup>3</sup> /min
<b>Operating temperature</b>	Continuous: -40 °C to +100 °C / Short-term: +120 °C
<b>Pre-separation</b>	Multi-cyclone block
<b>Main element</b>	CompacPleat element with double bellow technology, axial seal, metal-free
<b>Secondary element</b>	Pleated paper element, metal-free
<b>Selection criteria</b>	High power density, compact design, flexibility and long service life, dust discharge via valve does not require scavenging (scavenging as option)
<b>Typical applications</b>	Construction and agricultural machines, mining operations, etc.

PAGE 25



### IQORON-S – Single-stage plastic air cleaner

<b>Volume flow range</b>	4 m <sup>3</sup> /min to 10 m <sup>3</sup> /min
<b>Operating temperature</b>	Continuous: -30 °C to +90 °C / Short-term: +110 °C
<b>Main element</b>	CompacPleat element with double bellow technology, axial seal, metal-free
<b>Selection criteria</b>	High power density, compact design, flexibility, low pressure drop
<b>Typical applications</b>	Stationary environments with low dust load conditions, e.g. stationary compressors and generators, etc.

PAGE 36



### IQORON VP – Two-stage plastic air cleaner

<b>Volume flow range</b>	14 m <sup>3</sup> /min to 33 m <sup>3</sup> /min
<b>Operating temperature</b>	Continuous: -40 °C to +80 °C / Short-term: +90 °C
<b>Pre-separation</b>	Multi-cyclone block
<b>Main element</b>	VarioPleat element technology with high power density and simultaneously low pressure drop, pleated paper element, metal-free
<b>Secondary element</b>	Pleated paper element, metal-free
<b>Selection criteria</b>	High power density, compact design, flexibility and long service life, dust discharge via valve (scavenging available as option)
<b>Typical applications</b>	Construction and agricultural machines, mobile compressors, large material handling vehicles and mobile cranes, etc.

# Air cleaners

## Product overview

PAGE 48



**ENTARON XD** – Two-stage plastic air cleaner

<b>Volume flow range</b>	7 m <sup>3</sup> /min to 40 m <sup>3</sup> /min
<b>Operating temperature</b>	Continuous: -30 °C to +90 °C / Short-term: +110 °C
<b>Pre-separation</b>	Tangential inlet
<b>Main element</b>	Star-pleated element with plastic center tube and enhanced performance filter media with glue string technology, radial seal, metal-free (see chapter for variations)
<b>Secondary element</b>	Non-woven element with center tube, radial seal, metal-free
<b>Selection criteria</b>	High power density for conditions with very high mechanical stress, excellent flexibility through variable modular system, long service life, economy
<b>Typical applications</b>	Construction and agricultural machines, harvesters, forage harvesters, mobile compressors, construction site trucks, mobile cranes, gensets, etc.

PAGE 50



**ENTARON MD** – Single-stage plastic air cleaner

<b>Volume flow range</b>	20 m <sup>3</sup> /min to 40 m <sup>3</sup> /min
<b>Operating temperature</b>	Continuous: -30 °C to max. +80 °C
<b>Pre-separation</b>	Single-stage air cleaner – optionally extendable to combination air cleaner with separate DualSpin
<b>Main element</b>	Star-pleated element with plastic center tube, radial seal, metal-free
<b>Secondary element</b>	Non-woven element with center tube, radial seal
<b>Selection criteria</b>	Low flow resistance (single-stage air cleaner) or maximization of service life (combination air cleaner)
<b>Typical applications</b>	<p><b>Single-stage air cleaner:</b> Stationary applications (compressors, generators, large engines)</p> <p><b>Combination air cleaner (MD 40 + DualSpin):</b> Combine harvesters, forage harvesters, harvesters, construction and agricultural machines in very dusty conditions</p>

PAGE 62



**ENTARON HD** – Two-stage plastic air cleaner

<b>Volume flow range</b>	2 m <sup>3</sup> /min to 13 m <sup>3</sup> /min
<b>Operating temperature</b>	Continuous: -30 °C to +80 °C / Short-term: +110 °C
<b>Pre-separation</b>	Tangential inlet
<b>Main element</b>	Star-pleated element, center tube on housing, radial seal, metal-free
<b>Secondary element</b>	Non-woven element with center tube, radial seal, metal-free
<b>Selection criteria</b>	Compact dimensions, flexibility and economy with a long service life
<b>Typical applications</b>	Construction and agricultural machines, mobile compressors

PAGE 62



**ENTARON CD** – Single-stage plastic air cleaner

<b>Volume flow range</b>	2 m <sup>3</sup> /min to 8 m <sup>3</sup> /min
<b>Operating temperature</b>	Continuous: -30 °C to +80 °C / Short-term: +110 °C
<b>Main element</b>	Star-pleated element, center tube on housing, radial seal, metal-free
<b>Selection criteria</b>	Low pressure drop and excellent economy with low dust loads (single-stage air cleaner), compact dimensions
<b>Typical applications</b>	Stationary environments with low dust load conditions, e.g. stationary compressors and generators, etc.



# Air cleaners

## Product overview

PAGE 72



### NLG PICO - Single-stage plastic air cleaner

<b>Volume flow range</b>	10 m <sup>3</sup> /min to 45 m <sup>3</sup> /min
<b>Operating temperature</b>	Continuous: -40 °C to +80 °C / Short-term: +100 °C
<b>Main element</b>	Star-pleated element with center tube, radial seal, metal-free
<b>Secondary element</b>	Non-woven element with center tube, radial seal, metal-free
<b>Selection criteria</b>	Low pressure drop and excellent economy with low dust loads
<b>Typical applications</b>	Trucks, mobile cranes, buses, stationary compressors, generators

PAGE 78



### NLG PICLON - Two-stage plastic air cleaner

<b>Volume flow range</b>	10 m <sup>3</sup> /min to 40 m <sup>3</sup> /min
<b>Operating temperature</b>	Continuous: -40 °C to +80 °C / Short-term: +100 °C
<b>Pre-separation</b>	Guiding vanes to generate air spin
<b>Main element</b>	Star-pleated element with center tube, radial seal, metal-free
<b>Secondary element</b>	Non-woven element with center tube, radial seal, metal-free
<b>Selection criteria</b>	Excellent economy with medium dust loads
<b>Typical applications</b>	Mobile compressors, mobile cranes, construction site trucks, construction and agricultural machines

PAGE 82



### NLG DUALSPIN combination air cleaner

Two-stage plastic air cleaner

<b>Volume flow range</b>	18 m <sup>3</sup> /min to 50 m <sup>3</sup> /min
<b>Operating temperature</b>	Continuous: -40 °C to +80 °C / Short-term: +100 °C
<b>Pre-separation</b>	External mono-cyclone with integrated pressure recovery (DualSpin)
<b>Main element</b>	Star-pleated element with center tube, radial seal, metal-free
<b>Secondary element</b>	Non-woven element with center tube, radial seal, metal-free
<b>Selection criteria</b>	Long service life with high dust loads
<b>Typical applications</b>	Combine harvesters, forage harvesters, harvesters, construction and agricultural machines with very high dust loads

PAGE 92



### EUROPICLON - Two-stage plastic air cleaner

<b>Volume flow range</b>	0.8 m <sup>3</sup> /min to 15 m <sup>3</sup> /min
<b>Operating temperature</b>	Continuous: -40 °C to +80 °C / Short-term: +100 °C
<b>Pre-separation</b>	Tangential inlet
<b>Main element</b>	Star-pleated element, center tube on housing, radial seal, metal-free
<b>Secondary element</b>	Non-woven element with center tube, radial seal, metal-free
<b>Selection criteria</b>	Flexibility and economy with a long service life
<b>Typical applications</b>	Construction and agricultural machines, mobile compressors

# Air cleaners

## Product overview

PAGE 106



### PICLON – Two-stage metal air cleaner

<b>Volume flow range</b>	2 m <sup>3</sup> /min to 40 m <sup>3</sup> /min
<b>Operating temperature</b>	Continuous: -40 °C to +100 °C / Short-term: +120 °C
<b>Pre-separation</b>	Guiding vanes to generate air spin
<b>Main element</b>	Star-pleated element with center tube, axial seal, reinforced with metal
<b>Secondary element</b>	Non-woven element with center tube, axial seal, reinforced with metal
<b>Selection criteria</b>	Long service life with very high mechanical stress on the air cleaner housing
<b>Typical applications</b>	Construction and agricultural machines, engine construction

PAGE 116



### PICOLINO – Single-stage plastic air cleaner

<b>Volume flow range</b>	0.25 m <sup>3</sup> /min to 3.5 m <sup>3</sup> /min
<b>Operating temperature</b>	Continuous: -30 °C to +100 °C / Short-term: +120 °C
<b>Filter element</b>	Star-pleated element, radial seal, metal-free
<b>Typical applications</b>	Filters for two-way ventilation, small engines, small piston compressors, general mechanical engineering

PAGE 122



### PICOLIGHT – Single-stage air cleaner without housing

<b>Volume flow range</b>	1 m <sup>3</sup> /min to 80 m <sup>3</sup> /min
<b>Operating temperature</b>	Continuous: -30 °C to +80 °C / Short-term: +100 °C
<b>Filter element</b>	Star-pleated element, radial seal, metal-free
<b>Typical applications</b>	Stationary compressors, generators, marine applications

PAGE 126



### VACUUM AIR CLEANERS – Single-stage metal air cleaner

<b>Volume flow range</b>	0.7 m <sup>3</sup> /min to 12 m <sup>3</sup> /min
<b>Operating temperature</b>	Continuous: -30 °C to +80 °C / Short-term: +100 °C
<b>Filter element</b>	Star-pleated element with center tube, axial seal, reinforced with metal
<b>Typical applications</b>	Air and gas pipes with negative pressure (vacuum pumps)

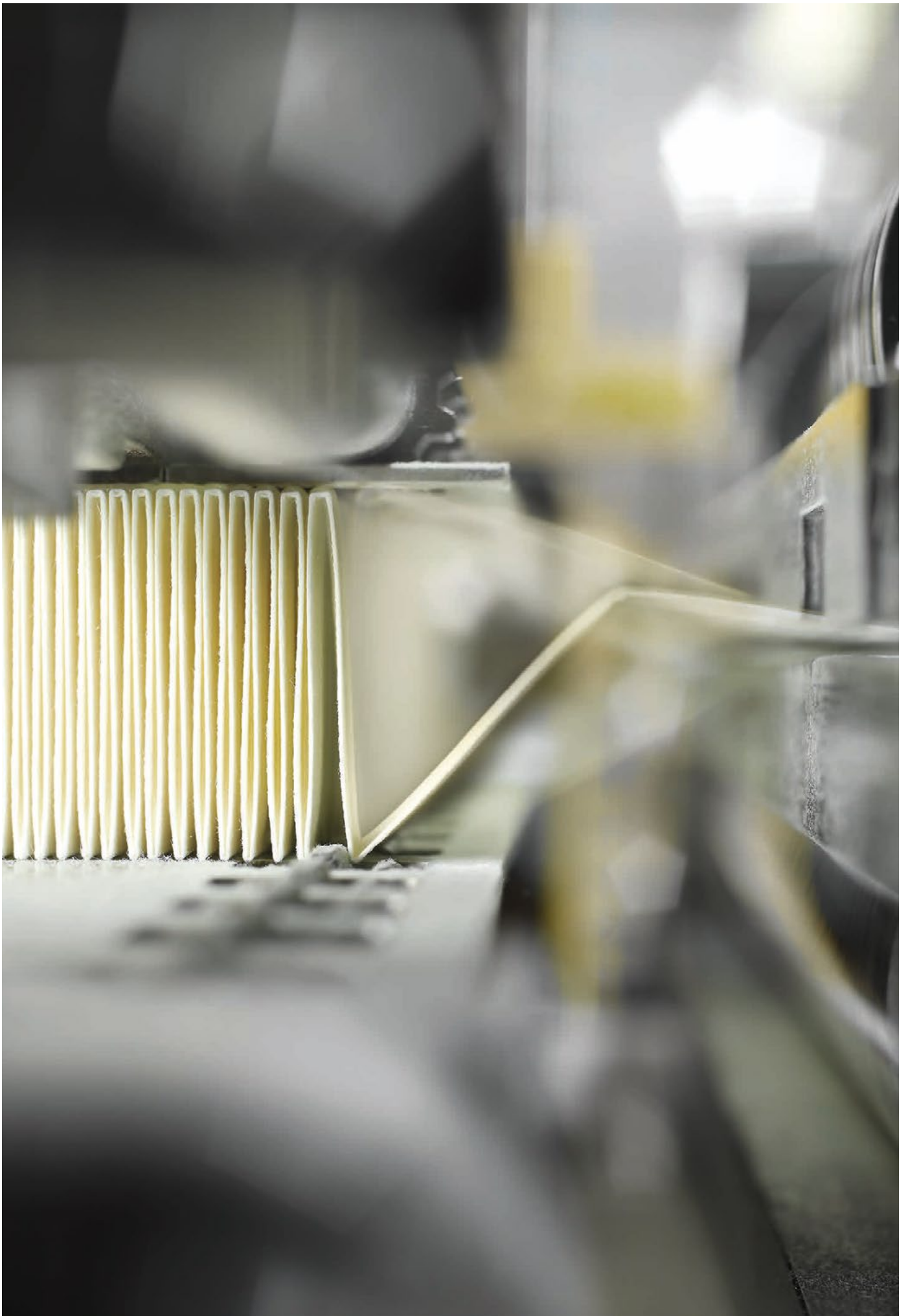



# IQORON series

## Compact air cleaners for tight installation spaces

**Tight installation spaces and high air flow rates are not in conflict for the IQORON two-stage air cleaner. The flexible designs of this series allow a number of possibilities for various applications. In addition, the complementary single stage air cleaners of this range are designed for all applications where there is a requirement for a low pressure drop.**

### ADVANTAGES

- Maximum service life through highly efficient cyclone pre-separation and CompacPleat element
- Inline air flow for flexible installation
- Environmentally-friendly disposal through filter elements which are metal-free
- Cr(VI)-free components
- Pre-separator easy to clean, if required
- Various mounting possibilities for quick installation
- Easy monitoring of the filter through integrated connection for service switch
- Polyamide reinforced with glass fiber for high temperature resistance up to +120 °C
- Low flow resistance with single-stage application as IQORON-S
- High reliability through proven seal concept

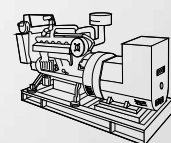
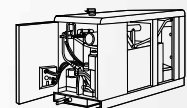
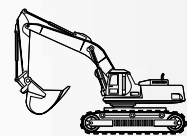

# IQORON series

## Compact air cleaners for tight installation spaces

### POWERFUL IN THE SMALLEST SPACE

When space is tight, IQORON air cleaners come into their own. Due to their compact designs, this series can be applied in increasingly complex and tight installation spaces.

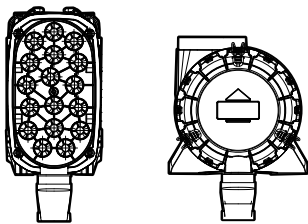

Comparison of the air cleaner housing of the IQORON-V (left) and the housing of a conventional air cleaner (right).

In comparison to similar air cleaners of other manufacturers, the use of polyamide reinforced with glass fiber enables a higher resistance to temperature. In continuous operation and depending on the model, the IQORON can be used with temperatures in the range of -40 °C to +100 °C and short-term with temperature peaks up to +120 °C. The inline air flow ensures excellent flexibility as it allows vertical as well as horizontal installation of the air cleaner. Depending on the variant, fast and easy maintenance is carried out as front or side servicing, relative to the flow direction.

### HIGH FILTER PERFORMANCE, MAXIMUM SERVICE LIFE

The core of the IQORON series is the CompacPleat filter element developed by MANN+HUMMEL with single or double bellow technology. The air flow design realizes a linear air flow through the air cleaner which enables flexible installation variants. In comparison to conventional filter elements, for the same installation space the CompacPleat element has a considerably higher filter surface area and therefore has the advantage of being able to provide a high power density and a long service life. The filter element is completely free of metal and is therefore fully incinerable. The removal frame found in a number of models can be reused.

### PERFECTLY MATCHING ACCESSORIES

For the IQORON-V air cleaner with side servicing concept, MANN+HUMMEL offers specially developed intake hoods with three variants for each filter size. These air connecting parts connect the multi-cyclone block of the filter with standard components on the dirty side. Insufficient technical adaptation of this accessory may result in a loss of filter performance and a reduction in service life of up to 70 percent. The solution is to use original intake hoods developed using simulation tools and extensive design expertise. They enable the perfect flow of air to the multi-cyclone cells and thus ensure that there is no negative influence on the pre-separation efficiency or the service life of the filter. The standardization of the accessories enables economic adaption to the respective installation conditions.

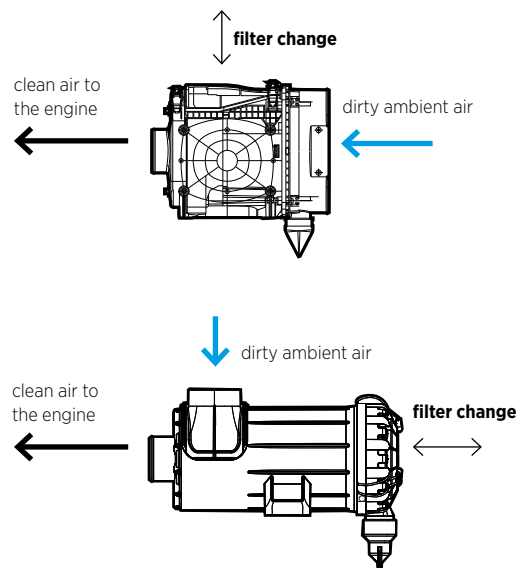

Comparison of the air flow of the IQORON-V air cleaner (above) and a conventional air cleaner (below).

# IQORON series

## At a glance



Technical features	IQORON	IQORON-V	IQORON-S
<b>Type of operation</b>	Two-stage air cleaner	Two-stage air cleaner	Single-stage air cleaner
<b>Field of application</b>	Applications with high dust loads such as agricultural and construction machines, etc.	Applications with high dust loads such as agricultural and construction machines, mobile compressors, etc.	Stationary applications with light dust loads such as compressors
<b>Air flow requirements</b>	4-14 m <sup>3</sup> /min	3-14 m <sup>3</sup> /min	4-10 m <sup>3</sup> /min
<b>Pre-separator</b>	Multi-cyclone block (cleanable as required)	Multi-cyclone block (cleanable as required)	-
<b>Pre-separation efficiency<sup>1)</sup></b>			
■ With dust discharge valve	-	Up to 90%	-
■ With scavenging (10%)	> 95%	Up to 95%	-
<b>Final separation efficiency</b>	> 99.97%	> 99.97%	> 99.97%
<b>Dust discharge</b>	Scavenging (e.g. ejector or blower)	Dust discharge valve (option: scavenging)	-
<b>Installation<sup>1)</sup></b>	Inline concept, vertical and horizontal installation possible, mounting with through-holes and/or threaded inserts	Inline concept, vertical and horizontal installation possible, mounting with through-holes and/or threaded inserts	Inline concept, vertical and horizontal installation possible, mounting with through-holes and/or threaded inserts
<b>Servicing concept</b>	Side servicing with standard fasteners	Front servicing with comfort fasteners: IQORON-V 4,5 and -V 7 Side servicing with comfort fasteners: IQORON-V 9 and -V 14	Front servicing with comfort fasteners
<b>Additional protection against ingress of water</b>	-	Option: IQORON-V 9 and -V 14	-

1) Depending on the size

# IQORON series

## High-performance details





# IQORON series

## High-performance details

### **1 MAIN ELEMENT**

The CompacPleat filter element with its large filter surface area offers a long service life for very tight installation spaces. The special design of the filter element enables a linear air flow through the air cleaner which opens up a wide range of installation options.

### **2 SECONDARY ELEMENT**

This safety element with additional reinforcement provides the best possible protection during the servicing of the main element. It is located beneficially for the flow behind the filter element and has a radial seal. This prevents the ingress of dirt into the intake system even when the filter element is removed during servicing. Therefore the engine components remain protected at all times.

### **3 PRE-SEPARATOR**

For applications with heavy dust loads, the IQORON is equipped with a highly efficient multi-cyclone block. If unfavorable operating conditions cause the pre-separator to block, it can be quickly and easily serviced if required. After untightening the holding screws, the cyclone block can be optionally removed from the housing and cleaned using compressed air or by washing out.

### **4 INSTALLATION**

Integrated through-holes enable quick and easy mounting of the IQORON V 4.5 and -V 7 models. In addition and for all other models of the IQORON series, a number of threaded inserts are available (option). This considerably accelerates the first installation of the air cleaner.

### **5 SERVICE SWITCH / INDICATOR**

The IQORON filter housing has an integrated M 10x1 threaded connection for a service switch or indicator in order to monitor the dirt level. If no service switch or sensor is used, the connection is sealed to be dust-tight using the supplied protection cover.

# IQORON

## Part numbers and specifications

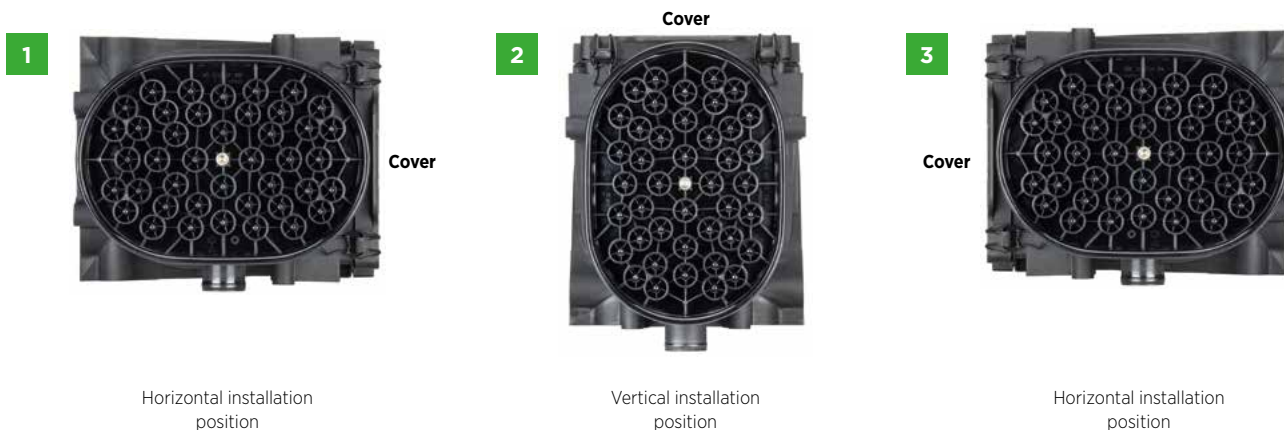

### PART NUMBERS

Model	Nominal flow rate [m <sup>3</sup> /min]	Position	Part number	Replacement filter element		Weight [kg]
			with secondary element	Main element	Secondary element	
IQORON 7	4-7	1	45 215 95 910	C 23 220	CF 2125	3.5
		2	45 215 95 911			
		3	45 215 95 912			
IQORON 10	5-10	1	45 395 95 910	C 27 380	CF 2530	5.0
		2	45 395 95 911			
		3	45 395 95 912			
IQORON 12	6-12	1	45 395 95 990	C 27 380	CF 2530	5.3
		2	45 395 95 991			
		3	45 395 95 992			

### SPECIFICATIONS

Model	Housing material	Dust discharge connection diameter	Tightening torque		Operating temperature		Discharge valve orientation (downwards)
			Hose clamp (clean side)	Threaded insert	Continuous	Short-term	
IQORON 7	PA6-GF30	40 mm (1.57 inches)	4 Nm	10 Nm	-30 °C to +100 °C	+120 °C	-
IQORON 10							
IQORON 12							

# IQORON

## Specifications

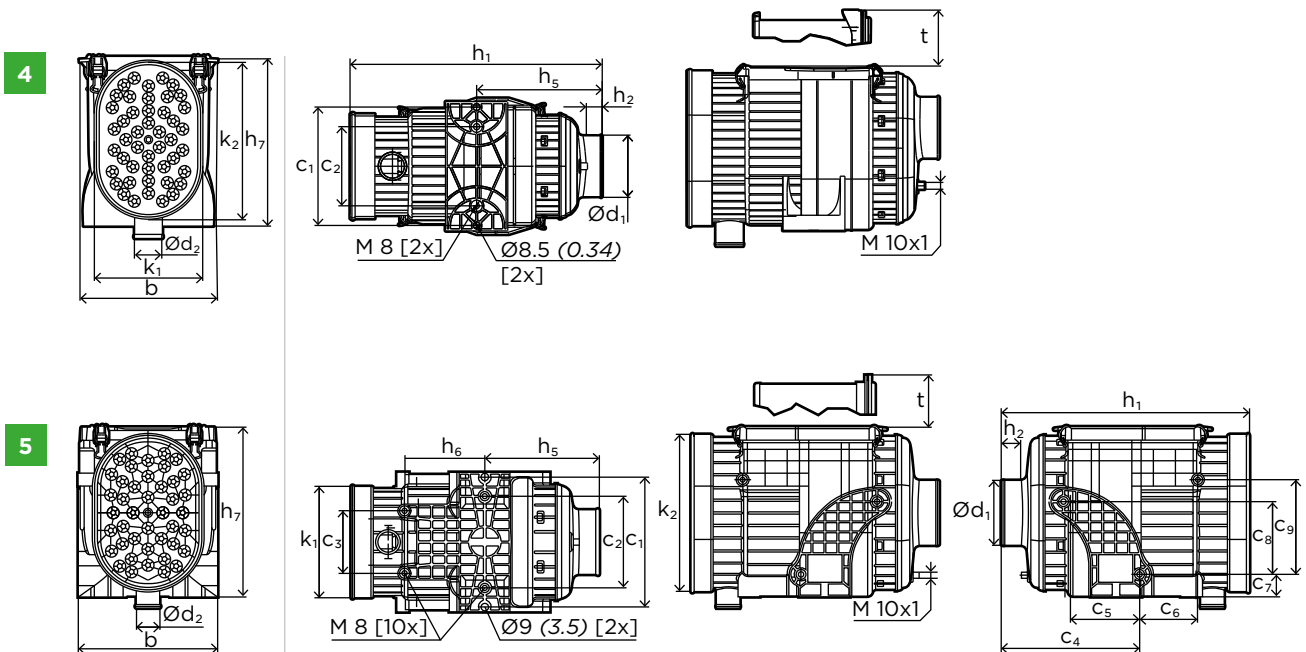

### DIMENSIONS

Model	Position	Dimensions in mm (dimensions in inches)									
		b	c <sub>1</sub>	c <sub>2</sub>	c <sub>3</sub>	c <sub>4</sub>	c <sub>5</sub>	c <sub>6</sub>	c <sub>7</sub>	c <sub>8</sub>	c <sub>9</sub>
IQORON 7	4	207.5 (8.17)	173 (6.81)	115.7 (4.56)	-	-	-	-	-	-	-
IQORON 10	5	236 (9.29)	218 (8.58)	155 (6.10)	105.4 (4.15)	233.4 (9.19)	128.4 (5.06)	98.4 (3.87)	37.7 (1.48)	123 (4.84)	159.9 (6.30)
IQORON 12	5	236 (9.29)	218 (8.58)	155 (6.10)	105.4 (4.15)	233.4 (9.19)	128.4 (5.06)	98.4 (3.87)	37.7 (1.48)	123 (4.84)	159.9 (6.30)
		d <sub>1</sub>	d <sub>2</sub>	h <sub>1</sub>	h <sub>2</sub>	h <sub>5</sub>	h <sub>6</sub>	h <sub>7</sub>	k <sub>1</sub>	k <sub>2</sub>	t
IQORON 7	4	89 (3.50)	40 (1.57)	368 (14.49)	30 (1.18)	183.5 (7.22)	-	240 (9.45)	153 (6.02)	226 (8.90)	225.3 (8.87)
IQORON 10	5	110 (4.33)	40 (1.57)	420 (16.54)	30 (1.18)	193.5 (7.62)	135.2 (5.32)	287 (11.30)	189 (7.44)	266 (10.47)	263.9 (10.39)
IQORON 12	5	110 (4.33)	40 (1.57)	425 (16.73)	30 (1.18)	193.5 (7.62)	135.2 (5.32)	287 (11.30)	216 (8.50)	293 (11.54)	263.9 (10.39)

# IQORON

## Flow characteristics

### IQORON 7 with scavenging (10%)

Flow rate

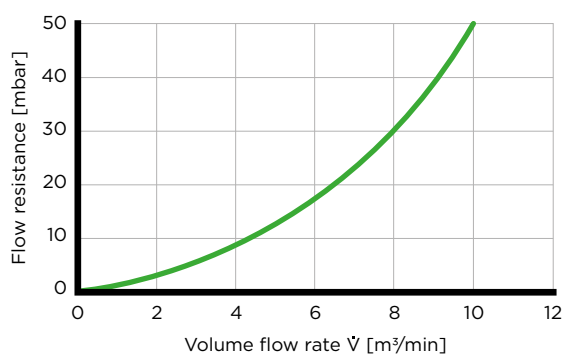

### IQORON 7 with scavenging (10%)

Dust capacity

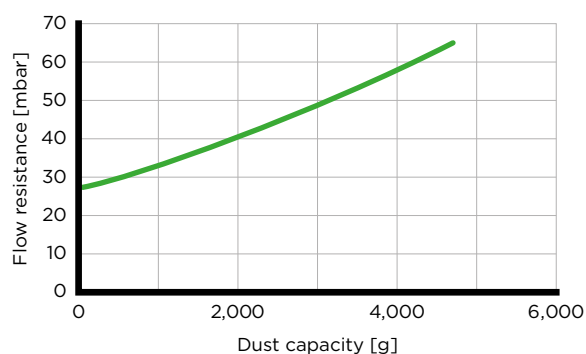

### IQORON 10 with scavenging (10%)

Flow rate

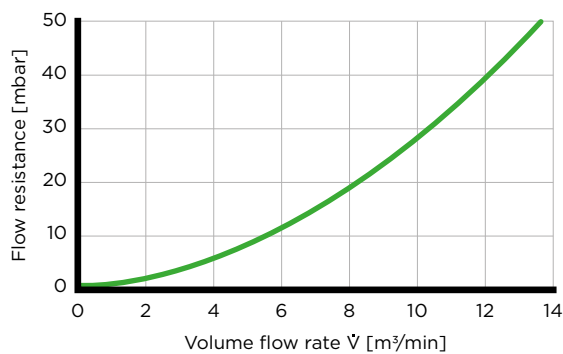

### IQORON 10 with scavenging (10%)

Dust capacity

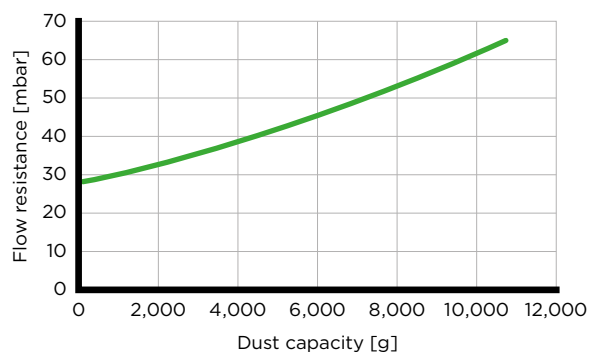

### IQORON 12 with scavenging (10%)

Flow rate

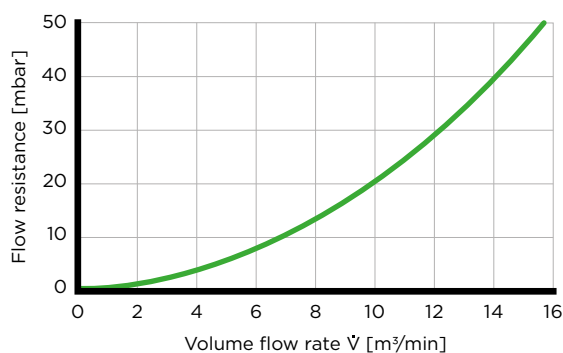

### IQORON 12 with scavenging (10%)

Dust capacity

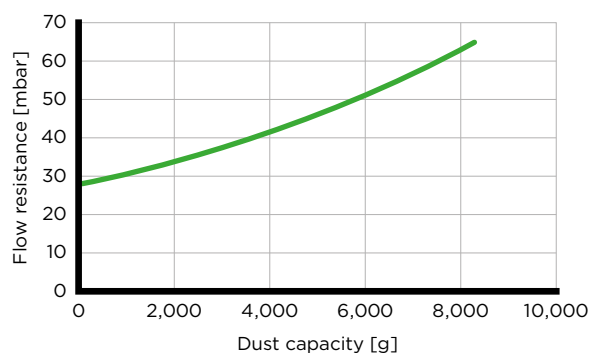

#### ■ With secondary element

Flow characteristics measured according to ISO 5011 with ISO coarse at nominal flow rates according to the specifications.



# IQORON-V

## Part numbers and specifications



### PART NUMBERS

Model	Nominal flow rate [m <sup>3</sup> /min]	Position	Part number	Replacement filter element		Weight [kg]
			with secondary element	Main element	Secondary element	
IQORON-V 4.5	3-4.5	1	45 180 95 910	C 22 041	CF 1941	2.9
		2	45 180 95 912			
IQORON-V 7	4-7	1	45 270 95 910	C 26 270	CF 2125/1	3.1
		2	45 270 95 911			
IQORON-V 9	5-9	3	45 402 95 910 <sup>1)</sup>	C 30 400/1	CF 2631	4.8
		4	45 402 95 911			
		3	45 402 95 912			
		4	45 402 95 913 <sup>2)</sup>			
		3	45 402 95 990 <sup>3)</sup>			
4	45 402 95 991 <sup>4)</sup>					
IQORON-V 14	7-14	3	45 580 95 910	C 34 540/1	CF 2944	5.9
		4	45 580 95 911			

1) Cover and dust discharge valve on the same side

2) Cover on left

3) Basic variant (4x M8, mounting on left)

4) Basic variant (4x M8, mounting on right)

### SPECIFICATIONS

Model	Housing material	Dust discharge connection diameter	Tightening torque			Operating temperature		Discharge valve orientation (downwards)
			Hose clamp (clean side)	Threaded insert	Through hole	Continuous	Short-term	
IQORON-V 4.5	PA6-GF30	54 mm (2.13 inches)	5 Nm	15 Nm	12 Nm	-40 °C to +100 °C	+120 °C	±15°
IQORON-V 7					12 Nm			
IQORON-V 9					-			
IQORON-V 14					-			

The IQORON-V is not IP certified.

# IQORON-V

## Specifications

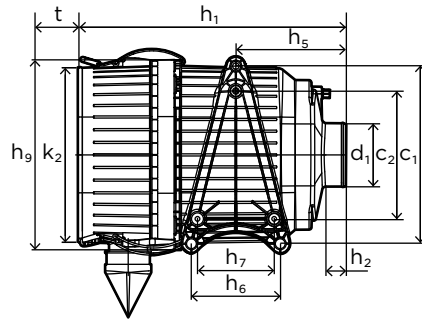
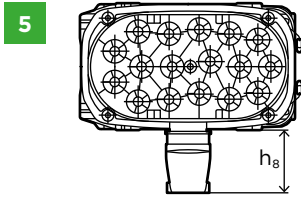

IQORON-V 4.5 and -V 7

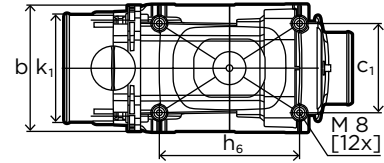

IQORON-V (symbolic representation)

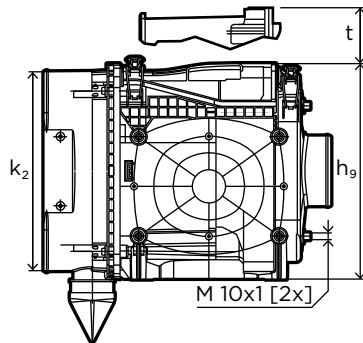
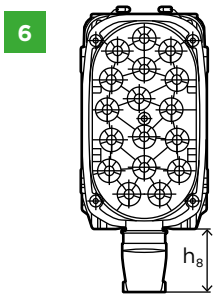

IQORON-V 9 and -V 14

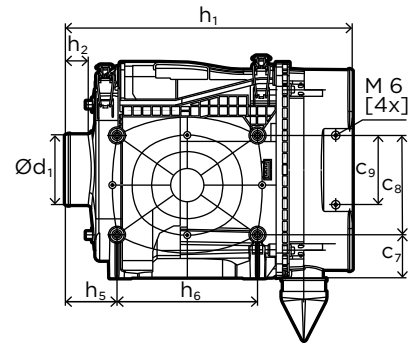

IQORON-V 9 and -V 14

### DIMENSIONS

Model	Dimensions in mm (dimensions in inches)								
	b	c <sub>1</sub>	c <sub>2</sub>	c <sub>7</sub>	c <sub>8</sub>	c <sub>9</sub>	d <sub>1</sub>	h <sub>1</sub>	h <sub>2</sub>
<b>IQORON-V 4.5</b>	143.1 (5.63)	244 (9.61)	172 (6.77)	-	-	-	82 (3.23)	393.3 (15.48)	31.7 (1.25)
<b>IQORON-V 7</b>	176.4 (6.95)	250 (9.84)	180 (7.09)	-	-	-	89.1 (3.51)	378 (14.88)	30 (1.18)
<b>IQORON-V 9</b>	185 (7.28)	130 (5.12)	-	63 (2.84)	145 (5.71)	100 (3.94)	102 (4.02)	418.8 (16.49)	34 (1.34)
<b>IQORON-V 14</b>	220.3 (8.67)	145 (5.71)	-	78.2 (3.08)	145 (5.71)	100 (3.94)	127 (5.00)	435.7 (17.15)	34 (1.34)
	<b>h<sub>5</sub></b>	<b>h<sub>6</sub></b>	<b>h<sub>7</sub></b>	<b>h<sub>8</sub></b>		<b>h<sub>9</sub></b>	<b>k<sub>1</sub></b>	<b>k<sub>2</sub></b>	<b>t</b>
				5	6				
<b>IQORON-V 4.5</b>	155 (6.10)	92 (3.62)	75 (2.95)	77.7 (3.06)	67.8 (2.67)	254.8 (10.03)	118.9 (4.68)	222 (8.74)	50 (1.97)
<b>IQORON-V 7</b>	155 (6.10)	125 (4.92)	108 (4.25)	88.5 (3.48)	86.1 (3.39)	268.8 (10.58)	153 (6.02)	245.4 (9.66)	50 (1.97)
<b>IQORON-V 9</b>	75.3 (2.97)	205 (8.07)	-	91.5 (3.60)	91.1 (3.59)	314.9 (12.40)	157.2 (6.19)	289.7 (11.41)	210.1 (8.27)
<b>IQORON-V 14</b>	78.2 (3.08)	205 (8.07)	-	89.5 (3.52)	86 (3.39)	346.3 (13.63)	190 (7.48)	316.3 (12.45)	218.7 (8.61)

# IQORON-V

## Flow characteristics

### IQORON-V 4.5

Flow rate

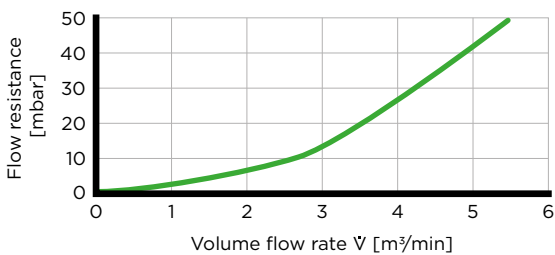

### IQORON-V 4.5

Dust capacity

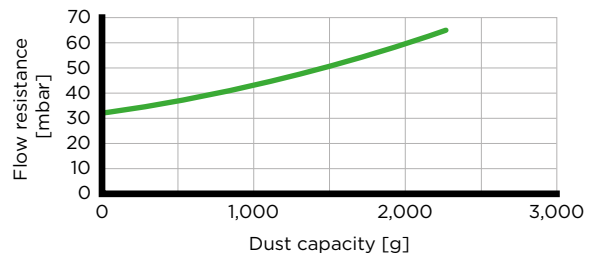

### IQORON-V 7

Flow rate

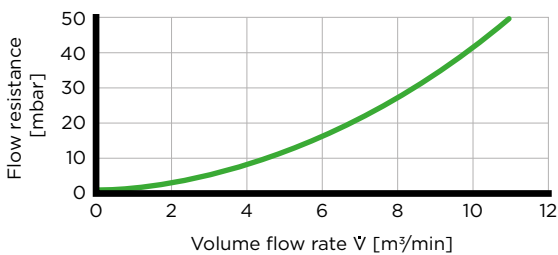

### IQORON-V 7

Dust capacity

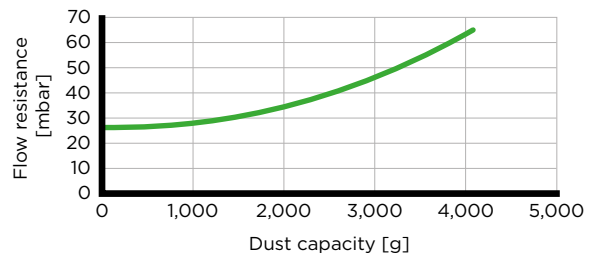

### IQORON-V 9

Flow rate

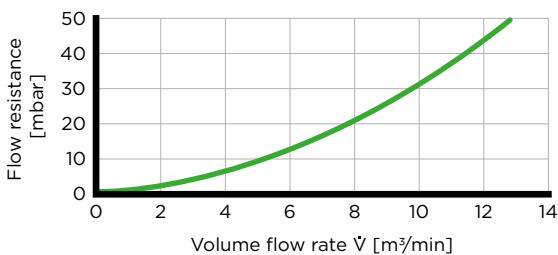

### IQORON-V 9

Dust capacity

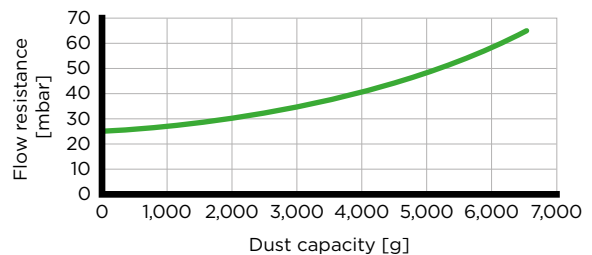

### IQORON-V 14

Flow rate

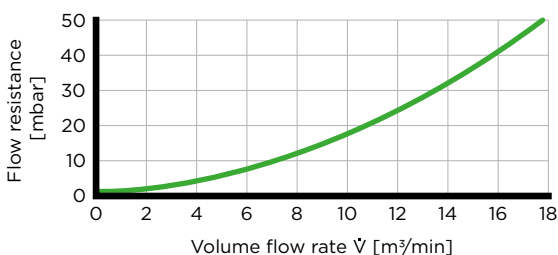

### IQORON-V 14

Dust capacity

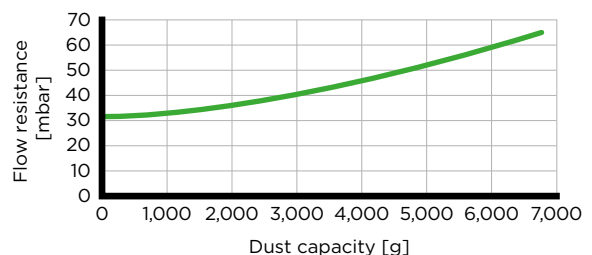

#### ■ With secondary element

Data for horizontal version and scavenging available on request.

Flow characteristics measured according to ISO 5011 with ISO coarse at nominal flow rates according to the specifications.



# IQORON-S

## Part numbers and specifications

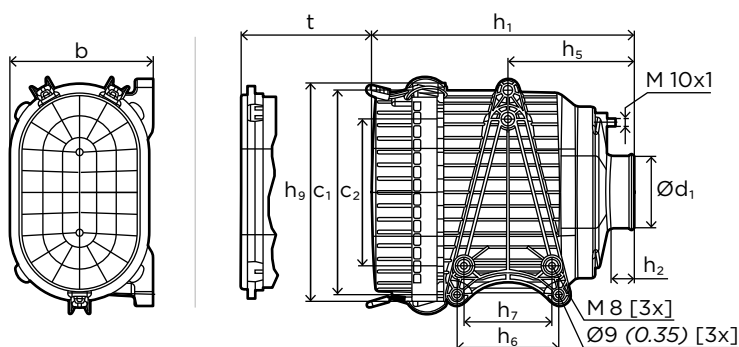

### PART NUMBERS

Model	Nominal flow rate [m³/min]	Part number		Replacement filter element		Weight [kg]
		without secondary element		Main element <sup>1)</sup>	Secondary element <sup>2)</sup>	
<b>IQORON-S 7</b>	4-10	45 270 75 912		C 26 270	-	2.7

1) Special variant CU 26 270 (filter element) for cabin filtration available on request.

2) Option: secondary element CF 2125/1

### SPECIFICATIONS

Model	Housing material	Dust discharge connection diameter	Tightening torque			Operating temperature		Discharge valve orientation (downwards)
			Hose clamp (clean side)	Threaded insert	Through hole	Continuous	Short-term	
<b>IQORON-S 7</b>	-	-	5 Nm	15 Nm	12 Nm	-40 °C to +100 °C	+120 °C	±15°

### DIMENSIONS

Model	Dimensions in mm (dimensions in inches)										
	b	c <sub>1</sub>	c <sub>2</sub>	d <sub>1</sub>	h <sub>1</sub>	h <sub>2</sub>	h <sub>5</sub>	h <sub>6</sub>	h <sub>7</sub>	h <sub>9</sub>	t
<b>IQORON-S 7</b>	176.4 (6.95)	250 (9.84)	180 (7.09)	89.1 (3.51)	324 (12.76)	30 (1.18)	155 (6.10)	125 (4.92)	108 (4.25)	267.9 (10.55)	105 (4.13)

### IQORON-S

Flow rate

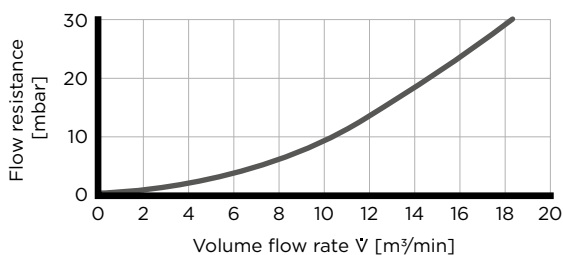

### IQORON-S

Dust capacity

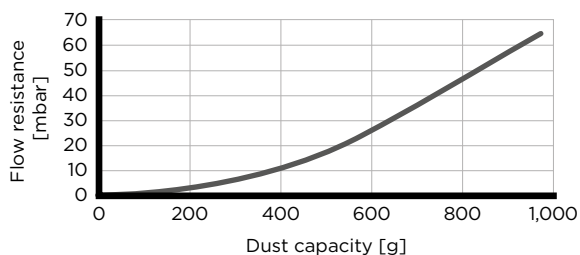

#### ■ Without secondary element

Flow characteristics measured according to ISO 5011 with ISO coarse at nominal flow rates according to the specifications.



# IQORON

## Spare parts

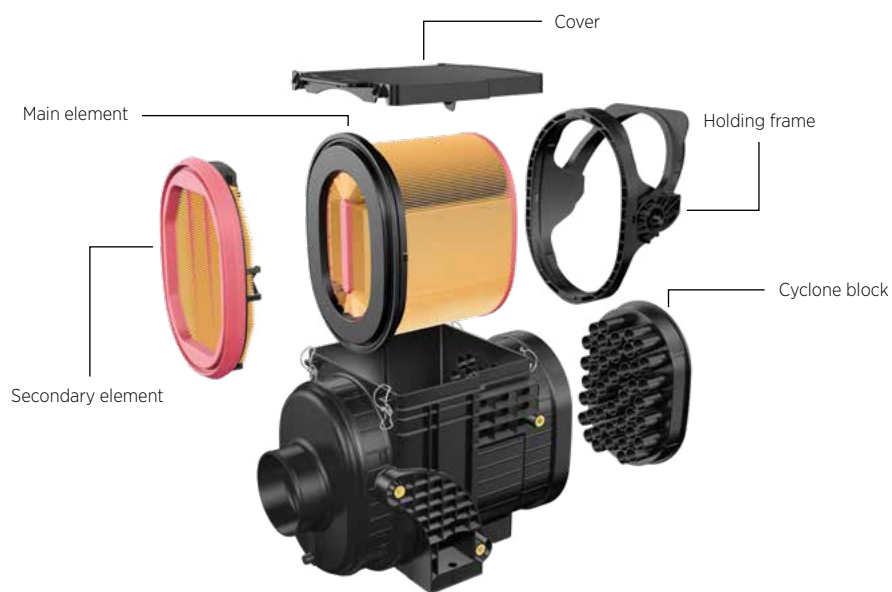

### PART NUMBERS

Model	Part number				Replacement filter element	
	Cover	Cyclone block	Holding frame	Screw	Main element	Secondary element
<b>IQORON 7</b>	45 215 17 999	45 210 12 998	-		C 23 220	CF 2125
<b>IQORON 10</b>	45 395 17 999	45 420 12 998	45 395 12 999	01 105 06 050	C 27 380	CF 2530
<b>IQORON 12</b>	45 395 17 999	45 550 12 999				



#### NOTE

The complete range of accessories for our air cleaners can be found starting on page 132.

# IQORON-S and -V

## Spare parts

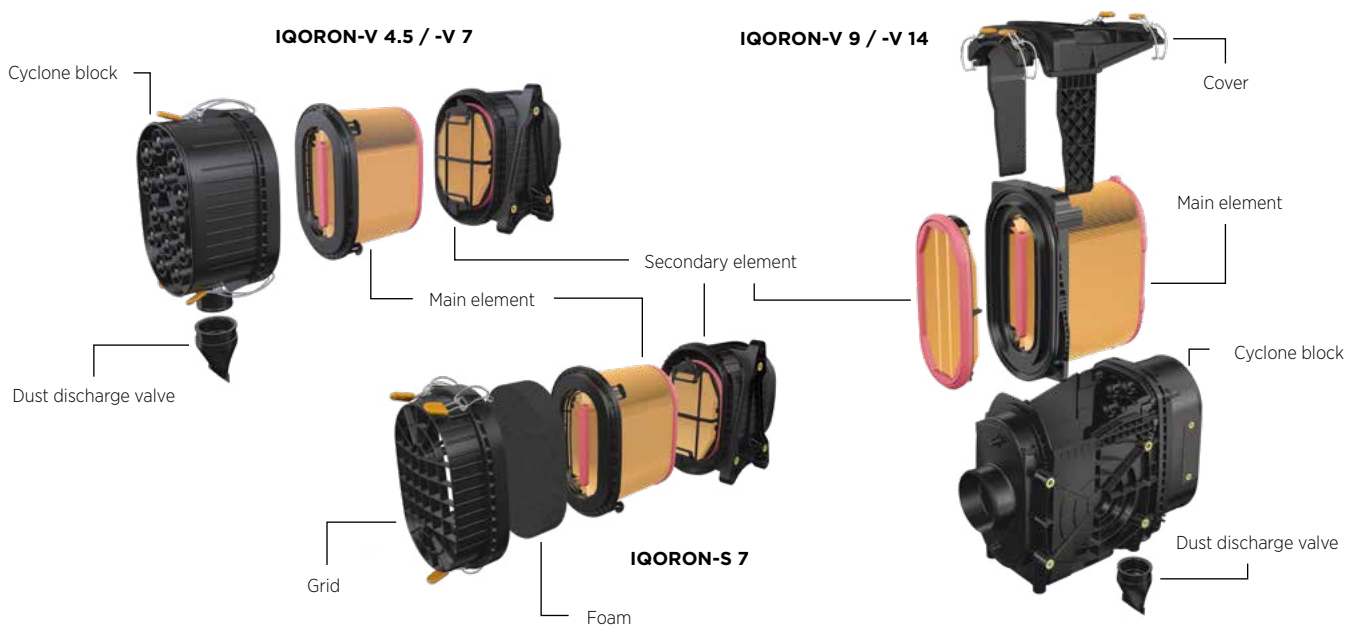

### PART NUMBERS

Model	Part number						Replacement filter element	
	Cyclone block		Dust discharge valve	Grid	Foam	Cover	Main element	Secondary element
	vertical	horizontal						
<b>IQORON-V 4.5</b>	45 180 12 999	45 180 12 998	39 000 40 391	-	-	-	C 22 041	CF 1941
<b>IQORON-S 7</b>	-	-	-	45 280 12 972	45 270 04 100	-	C 26 270	CF 2125/1
<b>IQORON-V 7</b>	45 280 47 982	45 280 47 962	39 000 40 731	-	-	-	-	-
<b>IQORON-V 9</b>	45 402 47 982	45 402 47 963	39 000 40 731	-	-	45 402 17 929	C 30 400/1	CF 2631
<b>IQORON-V 14</b>	45 580 47 981	45 580 47 961	39 000 40 731	-	-	45 580 17 929	C 34 540/1	CF 2294

# IQORON-V 9 and -V 14 Accessories (intake hoods)

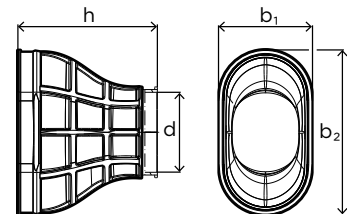
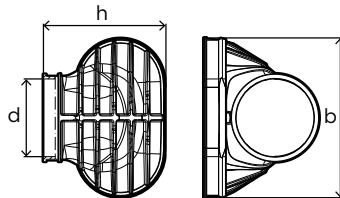
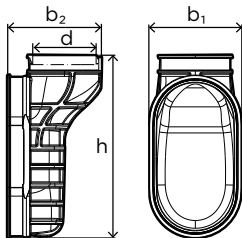

## PART NUMBERS

Model	Variant	Part number	Filter side hose clamp (connection to multi-cyclone block)	Raw air side hose clamp (customer side)	Hose clamp tightening torque
IQORON-V 9	1	45 402 97 910	02 018 01 204	02 018 01 200 02 018 01 202 02 018 01 202	7 Nm
	2	45 402 97 920			
	3	45 402 97 930			
IQORON-V 14	1	45 402 99 910	02 018 01 205	02 018 01 201 02 018 01 202 02 018 01 203	7 Nm
	2	45 402 99 920			
	3	45 402 99 930			

## DIMENSIONS

Model	Variant 1 Dimensions in mm <i>(dimensions in inches)</i>				Variant 2 Dimensions in mm <i>(dimensions in inches)</i>			Variant 3 Dimensions in mm <i>(dimensions in inches)</i>			
	b <sub>1</sub>	b <sub>2</sub>	d	h	b	d	h	b <sub>1</sub>	b <sub>2</sub>	d	h
IQORON-V 9	176 (6.93)	177.4 (6.98)	120 (4.72)	345.9 (13.62)	308.4 (12.14)	150 (5.90)	236.5 (9.31)	176 (6.93)	308.4 (12.14)	150 (5.91)	261 (10.28)
IQORON-V 14	210.4 (8.27)	209.4 (8.24)	140 (5.51)	373.2 (14.69)	336.4 (13.23)	150 (5.90)	224.4 (8.83)	210 (8.27)	336 (13.23)	180 (7.09)	264.4 (10.41)

Connection on  
the raw air side

Connection on  
the filter side

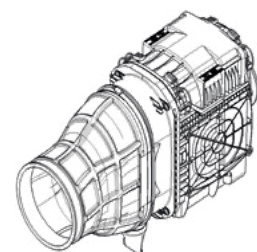
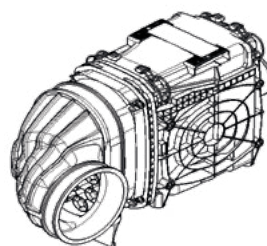
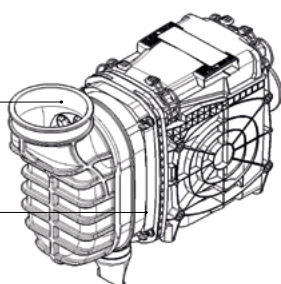



# IQORON VP

## The compact power pack

The IQORON VP range was developed especially for applications with medium to heavy dust loads. The compact and innovative two-stage air cleaner equipped with the new VarioPleat filter element is designed for applications with an output of 400 kW or more where installation space is tight. The unique concept enables a short air flow path to the engine. In comparison to similar solutions available on the market, the IQORON VP achieves up to 70 percent longer service life.

### ADVANTAGES

- Horizontal and vertical operation without loss in performance through improved multi-cyclone block
- Simple and economical scavenging installation using low negative pressure at scavenge port
- Up to 70 percent longer service life for operation with dust discharge valve possible
- Excellent application flexibility due to a modular and lean design
- Shortened air flow routings to engine through 45 degree clean air connection
- Up to 15 percent less space required when using an optional clean air elbow
- Cr(VI)-free components
- High-performance VarioPleat filter element enables high power density
- Integrated handle solution on filter element enables easy handling during service

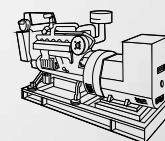
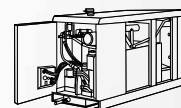
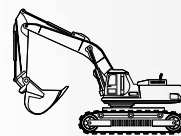

# IQORON VP

## The compact power pack

### IMPROVED SEPARATION PERFORMANCE

The performance of the IQORON VP is ideally suited for medium to heavy dust loads. Implementation of an updated multi-cyclone pre-separator allows the air cleaner an improvement in performance for non-scavenged applications. The IQORON VP can be installed with a dust discharge valve in horizontal and vertical installation positions without a decrease in performance.

As an option, the IQORON VP is also available as a single-stage air cleaner (i.e. without multi-cyclone block pre-separator). In heavy dust environments similar to agricultural applications, the DualSpin XT pre-separator can be attached to the IQORON VP for improved handling of organic and fibrous dusts. When combined with scavenging this achieves excellent pre-separation efficiency. A special design of the guiding vanes considerably reduces pressure drop in the pre-separator. Generously dimensioned flow paths virtually exclude the possibility of air cleaner plugging.

### VARIABLE ELEMENT GEOMETRY

The unique VarioPleat filter element concept enables a particularly high power density for filter systems with an axial flow. Individual pleats within the filter can be optimized to the space available utilizing steps or curves to allow conformance to the available space.

Tight installation spaces can now be fully utilized with the geometrical design freedom of the VarioPleat. As a result, the air cleaner can find application even when the installation requirements are complex. Innovation of the element manufacturing technology yields a lower pressure drop when compared to other filter element technologies. Clogging of the pleats by large debris is minimized by the stabilized structure of the element.

The VarioPleat element technology is used as standard in the IQORON VP range and also in custom designed solutions.

### FLEXIBLE COMPACT DESIGN

The modular design of the compact IQORON VP two-stage air cleaner allows easy adaption to a single-stage air cleaner and can therefore be flexibly adapted to complex applications. The special characteristics of the air cleaner make it very suitable for tight installation spaces with numerous advantages:

- Slim, compact design for installation in complex installation spaces
- Threaded inserts offer numerous mounting possibilities and simplify installation of the air cleaner

#### Components available as an option:

- Configurable connections through 45 degree clean air elbow enable short air flow routing with low flow resistance
- Integration of a reinforcing ring in the elbow allows high tightening torques for a durable connection.

In comparison to similar solutions available on the market, the unique concept of the IQORON VP air cleaner achieves an increase in service life of up to 70 percent.



The innovative design of the VarioPleat filter element enables variable pleat heights.



# IQORON VP

## At a glance



Technical features	IQORON VP
Type of operation	Two-stage air cleaner
Field of application	Mobile applications with very high dust loads such as construction machines, construction site trucks, harvesters, tractors, mobile cranes, mobile compressors etc.
Air flow requirements	14-33 m <sup>3</sup> /min
Pre-separation efficiency	
<ul style="list-style-type: none"> <li>■ With dust valve</li> <li>■ With scavenging (10%)</li> </ul>	<p>85%</p> <p>&gt; 90%</p>
Final separation efficiency	> 99.99%
Dust discharge	Dust discharge valve (option: scavenging)
Installation	Vertical and horizontal installation possible <sup>1)</sup>
Servicing concept	Side access with comfort fasteners
Additional protection against water ingress	Cover gasket on request
Special variants	Available on request as single-stage air cleaner without cyclone block

1) Depends on the position of the dust discharge valve (valve always directed downwards); not relevant for operation with scavenging

# IQORON VP

## High-performance details



Picture of filter configuration with overhead installation.

# IQORON VP

## High-performance details

### 1 HOUSING

The housing of the IQORON VP can be installed in a vertical or horizontal position without the loss of performance. It is extremely robust and is made from plastic reinforced with glass fiber. Its slim design was especially designed for extremely tight installation spaces. The numerous installation possibilities with threaded inserts simplify the installation of the air cleaner. In addition, other customer components can be mounted using self-tapping screws.

### 2 VARIOPLEAT FILTER ELEMENT

The innovative VarioPleat filter element is a unique feature. The variable pleat heights offered by the element enable high filtration performance and simultaneously a low flow restriction. Customized printing on the elements is available on request.

### 3 SECONDARY ELEMENT

The secondary element reinforced with its robust plastic frame offers additional security when changing the filter element.

### 4 MULTI-CYCLONE PRE-SEPARATOR

Equipped with high-efficient multi-cyclone separation technology, operation is possible with or without scavenging in a vertical or horizontal installation position. With scavenging, the pre-separation efficiency can be significantly increased to more than 90 percent and thus ensures a further increase in performance.

### 5 45 DEGREE CLEAN AIR OUTLET (OPTION)

Configurable outlet orientations enable short air flow routing with minimum flow resistance. The integrated reinforcement ring enables a high tightening torque for a secure connection.

### 6 SERVICE SWITCH CONNECTION

Sensor connections with an external thread of M 10x1 are available on both sides in a protected position.

### 7 SERVICING

The IQORON VP has a special comfort fastening system which allows access without the need for tools. Handles on the main and secondary elements simplify handling and require little effort.



Servicing the IQORON VP

# IQORON VP

## Part numbers and specifications

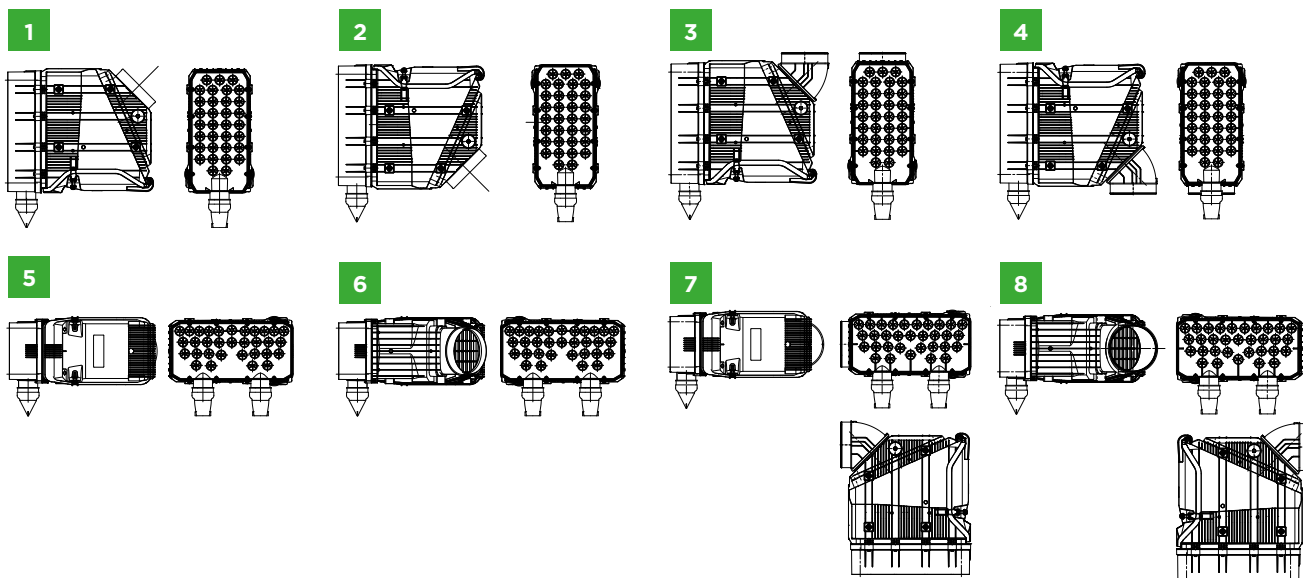

### PART NUMBERS

Model	Nominal flow rate [m <sup>3</sup> /min]	Position	Part number	Replacement filter element		Weight [kg]
			with secondary element	Main element	Secondary element	
IQORON VP 19	14-19	1	45 919 95 910	C 42 003	CF 42 001	8.8
		2	45 919 95 912			
		3*	14 908 91 S01			
		4*	45 919 95 920			
		5	45 919 95 911			
		6	45 919 95 913			
		7*	14 908 93 S01			
		8*	14 908 94 S01			
IQORON VP 25	18-25	1	45 925 95 910	C 45 002	CF 45 001	10.1
		2	45 925 95 912			
		3*	14 909 38 S01			
		4*	45 925 95 920			
		5	45 925 95 911			
		6	45 925 95 913			
		7*	14 909 39 S01			
		8*	14 909 40 S01			
IQORON VP 33	24-33	1	45 933 95 910	C 50 003	CF 50 001	12.4
		2	45 933 95 912			
		3*	14 909 42 S01			
		4*	45 933 95 920			
		5	45 933 95 911			
		6	45 933 95 913			
		7*	14 909 43 S01			
		8*	14 909 44 S01			

\* Other spigot orientations possible on request

### SPECIFICATIONS

Model	Housing material	Dust discharge connection diameter	Tightening torque		Operating temperature		Discharge valve orientation (downwards)
			Hose clamp (clean side)	Threaded insert	Continuous	Short-term	
IQORON VP 19	PP-GF30	74 mm (2.91 inches)	4 Nm	15 Nm	-40 °C to +80 °C	+90 °C	±15 °
IQORON VP 25							
IQORON VP 33							

# IQORON VP

## Specifications

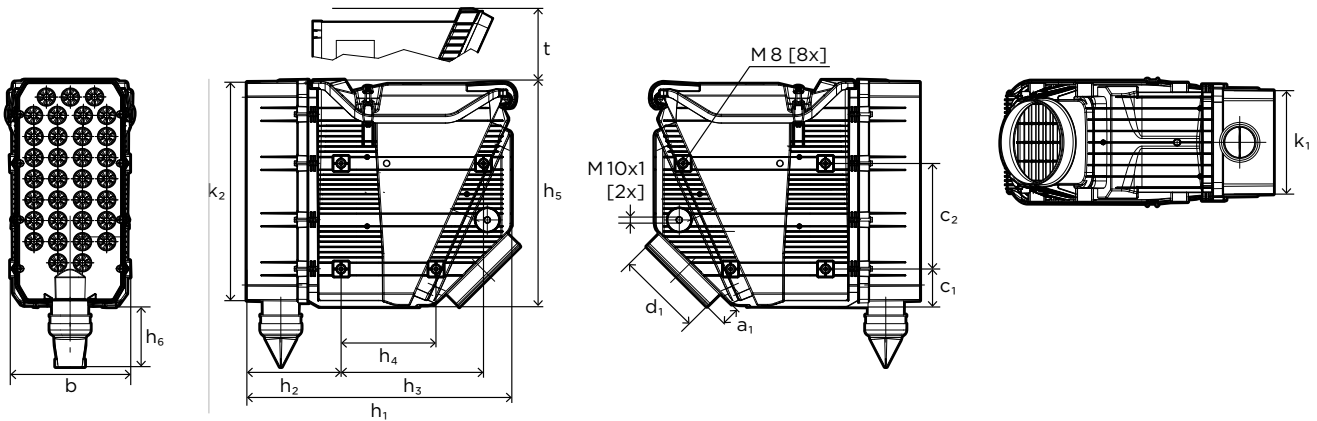

### DIMENSIONS

Model	Dimensions in mm (dimensions in inches)													
	a <sub>1</sub>	b	c <sub>1</sub>	c <sub>2</sub>	d <sub>1</sub>	h <sub>1</sub>	h <sub>2</sub>	h <sub>3</sub>	h <sub>4</sub>	h <sub>5</sub>	h <sub>6</sub>	k <sub>1</sub>	k <sub>2</sub>	t
<b>IGORON VP 19</b>	40 (1.57)	223 (8.78)	63 (2.48)	224 (8.82)	150 (5.91)	540 (21.26)	186 (7.32)	301 (11.85)	200 (7.87)	452 (17.80)	120 (4.72)	185 (7.28)	430 (16.93)	375 (14.76)
<b>IGORON VP 25</b>	36 (1.42)	253 (9.96)	81 (3.19)	225 (8.86)	180 (7.09)	559 (22.01)	196 (7.72)	302 (11.89)	202 (7.95)	484 (19.06)	128 (5.04)	220 (8.66)	465 (18.31)	400 (15.75)
<b>IGORON VP 33</b>	45 (1.77)	289 (11.38)	81 (3.90)	256 (20.71)	203 (7.99)	574 (22.60)	188 (7.40)	318 (12.52)	201 (7.91)	523 (20.59)	117 (4.61)	254 (10.00)	490 (19.29)	440 (17.32)

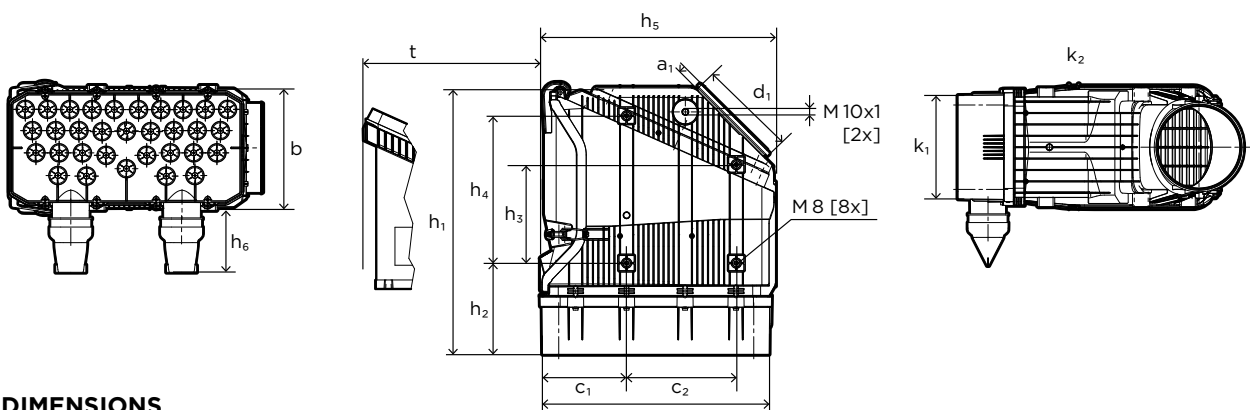

### DIMENSIONS

Model	Dimensions in mm (dimensions in inches)													
	a <sub>1</sub>	b	c <sub>1</sub>	c <sub>2</sub>	d <sub>1</sub>	h <sub>1</sub>	h <sub>2</sub>	h <sub>3</sub>	h <sub>4</sub>	h <sub>5</sub>	h <sub>6</sub>	k <sub>1</sub>	k <sub>2</sub>	t
<b>IGORON VP 19</b>	40 (1.57)	223 (8.78)	63 (2.48)	224 (8.82)	150 (5.91)	540 (21.26)	186 (7.32)	301 (11.85)	200 (7.87)	452 (17.80)	120 (4.72)	185 (7.28)	430 (16.93)	375 (14.76)
<b>IGORON VP 25</b>	36 (1.42)	253 (9.96)	81 (3.19)	225 (8.86)	180 (7.09)	550 (21.65)	187 (7.36)	302 (11.89)	202 (7.95)	484 (19.06)	128 (5.04)	220 (8.66)	465 (18.31)	400 (15.75)
<b>IGORON VP 33</b>	45 (1.77)	289 (11.38)	81 (3.90)	256 (20.71)	203 (7.99)	574 (22.60)	188 (7.40)	318 (12.52)	201 (7.91)	523 (20.59)	117 (4.61)	254 (10.00)	490 (19.29)	440 (17.32)

# IQORON VP

## Flow characteristics

### IQORON VP 19

Flow rate

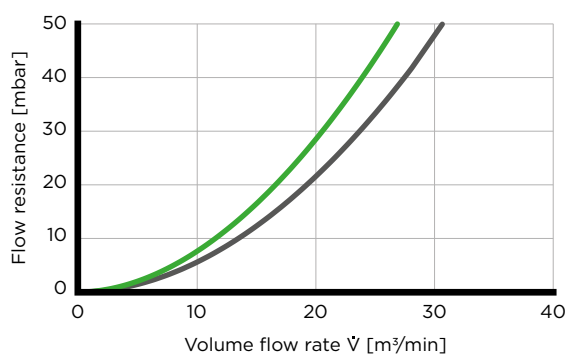

### IQORON VP 19

Dust capacity

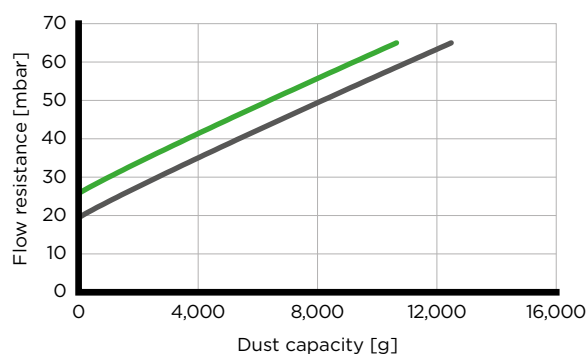

### IQORON VP 25

Flow rate

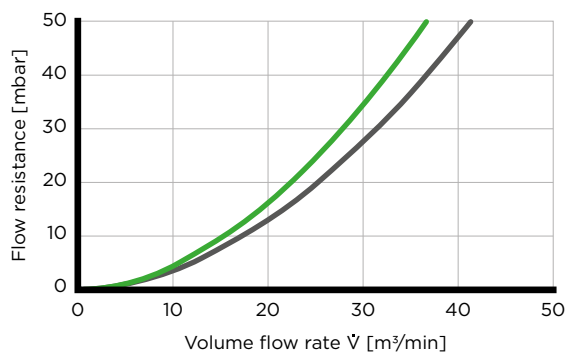

### IQORON VP 25

Dust capacity

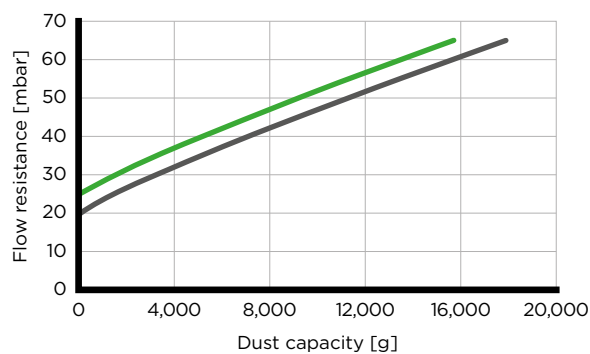

### IQORON VP 33

Flow rate

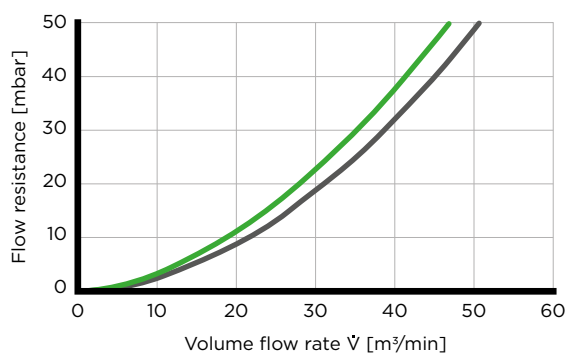

### IQORON VP 33

Dust capacity

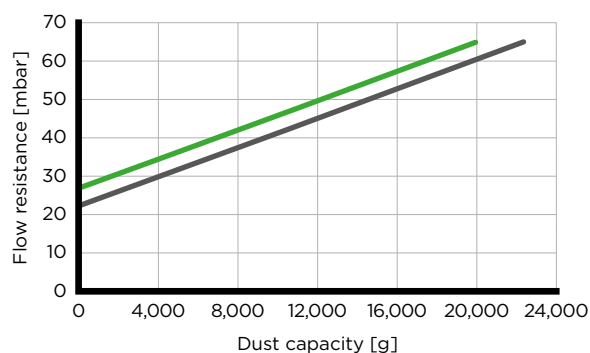

■ With secondary element ■ Without secondary element

Data with scavenging on request.

Flow characteristics measured according to ISO 5011 with ISO coarse at nominal flow rates according to the specifications.

# IQORON VP

## Spare parts

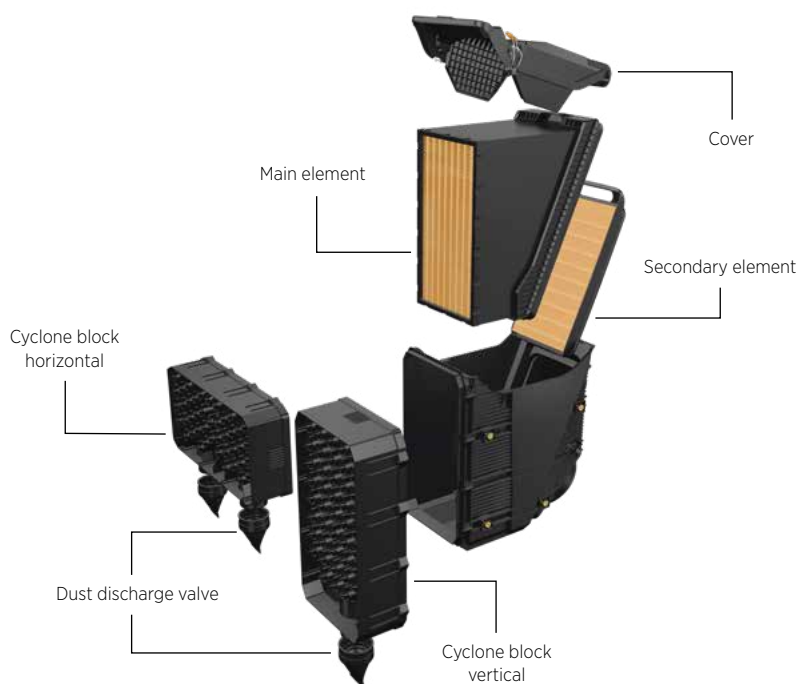

### PART NUMBERS

Model	Part number					Replacement filter element	
	Cyclone block		Dust discharge valve <sup>1)</sup>	Cover	Cover seal	Main element	Secondary element
	vertical	horizontal					
<b>IQORON VP 19</b>	45 919 47 982	45 919 47 962	39 000 40 291	45 919 17 929	23 355 33 208 <sup>2)</sup>	C 42 003	CF 42 001
<b>IQORON VP 25</b>	45 925 47 982	45 925 47 962	39 000 40 291	45 925 17 929	23 355 33 209	C 45 002	CF 45 001
<b>IQORON VP 33</b>	45 933 47 982	45 933 47 962	39 000 40 291	45 933 17 929	23 355 33 207 <sup>2)</sup>	C 50 003	CF 50 001

1) Long dust discharge valve available as alternative on page 55.

2) On request

# IQORON VP Accessories



## **COMBINATION WITH DUALSPIN XT AND POWER PACK SOLUTION**

The IQORON VP single stage air cleaner can be combined with the DualSpin XT pre-separator for heavy dust loads. The air cleaner system is suitable for installation in a vertical and horizontal position.

The combination of the DualSpin XT with the IQORON VP requires scavenging.

The connecting piece between IQORON VP and DualSpin XT is not included in the MANN+HUMMEL scope of delivery.



## **AIR CONNECTING PARTS**

Different options on pages 138-144.



## **SERVICE SWITCHES - ELECTRICAL MONITORING OF THE LEVEL OF ACCUMULATED DIRT**

More on page 146.



### **NOTE**

The complete range of accessories for our air cleaners can be found starting on page 132.







# ENTARON XD/MD

## Developed for challenging demands

The ENTARON XD from MANN+HUMMEL sets new standards for plastic two-stage air cleaners with a tangential raw air inlet. The ENTARON range extends the proven characteristics of the successful Europiclon and NLG air cleaners with plenty of new ingenious ideas. The single-stage version ENTARON MD with very low initial pressure drop complements the XD range.

### ADVANTAGES

- Excellent protection of the engine through high initial and final separation efficiencies
- Corrosion-free and extra robust housing made from plastic reinforced with glass fiber
- Cr(VI)-free components
- High reliability through elements with new type of sealing system
- Considerable reduction in weight compared to conventional metal or hybrid solutions
- Excellent flexibility through variable modular system
- Straightforward adaptation to many applications through different inlet positions
- Easy maintenance due to tool-less element change with comfort fasteners

### ENTARON XD

- Environmentally-friendly and economical disposal through filter elements which are metal-free and fully incinerable (except ENTARON XD 40)
- Especially long filter service life through integrated pre-separation

### ENTARON MD

- Low flow resistance reduces operating costs
- Separation of the functions of pre-separation and main filtration enables a long service life as needed

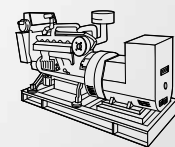
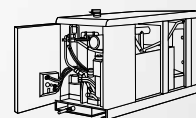
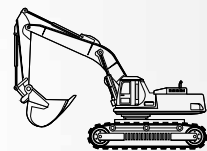

# ENTARON XD/MD

## Developed for challenging demands

### ROBUST HOUSING

The housings of the ENTARON XD and ENTARON MD are equipped with reinforcement ribs and manufactured from plastic reinforced with glass fiber. This has the advantage of reducing weight by 10 percent in comparison to conventional metal or hybrid air cleaners (combinations of metal and plastic). As a result, the air cleaner is able to handle even extreme mechanical requirements. At the same time the design offers the advantage of resistance to corrosion.

The housing consists of three parts with the main part joined to the raw air inlet by a special welding process. This welding provides a robust and secure connection and enables the required orientation of the connection to the integrated brackets. This achieves maximum flexibility which allows the air cleaner to be adapted to almost all installation situations. In addition, the clean air outlet is reinforced by a metal ring which enables a tightening torque for hose clamps up to 5 Newton meters.

The high pre-separation efficiency uniquely qualifies the ENTARON XD for heavy dust load applications. This high efficiency sets the standard for its filter class and eliminates the need for an additional external pre-separator.

### SMART DETAILS

The comfort fasteners have color-coded operating elements. This simplifies handling and makes it immediately easy to understand, even when visibility is poor. Special snap-in noses allow the fasteners to be fixed - so they no longer interfere

with the removal or fitting of the cover when servicing is required. A smart and user-friendly detail.

Furthermore, the ENTARON XD/MD series has a connection for a service switch or service indicator integrated in the housing and also integrated mounting possibilities with through-holes (standard) and threaded inserts (on request) to enable quick installation.

### HIGH-PERFORMANCE FILTER ELEMENTS

The filter elements of the ENTARON XD/MD series are also designed for the highest requirements:

- A new type of sealing system ensures the reliable sealing of the elements to the housing.
- Robust center tubes made from plastic reinforce the filter element\*.
- A new filter media used in the ENTARON XD/MD offers significantly higher separation efficiency with a simultaneously long service life.
- The glue string technology exclusively used by MANN+HUMMEL fixes the tops of the pleats and therefore ensures that the element offers high performance under all operating conditions.
- The safety element in the ENTARON XD/MD is threaded to the housing which prevents unintentional removal during servicing.
- Further versions of the main filter and secondary filter elements are available for the ENTARON XD and ENTARON MD as options.

\*Not applicable for ENTARON XD/MD 40.

# ENTARON XD/MD

## At a glance



Technical features	ENTARON XD 14 to 40	ENTARON MD 40	ENTARON MD 40 with DualSpin XT
<b>Type of operation<sup>1)</sup></b>	Two-stage air cleaner	Single-stage air cleaner	Combination air cleaner: single-stage air cleaner with external pre-separator <sup>1)</sup>
<b>Field of application</b>	Mobile applications with a very high dust load such as construction machines, construction site trucks, harvesters, mobile cranes, mobile compressors, etc.	Stationary applications with a low dust load such as stationary machines, gensets, compressors, etc.	Applications with extreme dust load such as large harvesters
<b>Air flow requirements</b>	7-40 m <sup>3</sup> /min	20-40 m <sup>3</sup> /min	20-40 m <sup>3</sup> /min
<b>Pre-separation efficiency</b>			
■ With dust discharge valve	87%	-	-
■ With scavenging (5%)	92%	-	-
■ With scavenging (10%)	-	-	> 89%
<b>Final separation efficiency</b>	> 99.99%	> 99.97%	> 99.97%
<b>Dust discharge</b>	Dust discharge valve (scavenging available as option)	-	Scavenging
<b>Installation</b>	Vertical and horizontal installation possible <sup>2)</sup>	Vertical and horizontal installation possible	Vertical and horizontal installation possible
<b>Servicing concept</b>	Front access with comfort fasteners	Front access with comfort fasteners	Front access with comfort fasteners
<b>Additional protection against ingress of water</b>	On request <sup>3)</sup> /Standard <sup>4)</sup>	Standard	Standard

1) The connecting piece between ENTARON MD 40 and DualSpin XT is not included in the MANN+HUMMEL scope of delivery.

2) Depends on the position of the dust discharge valve (valve always directed downwards).

3) ENTARON XD 14 to 28

4) ENTARON XD 40

# ENTARON XD/MD

## High-performance details



Example of the ENTARON XD 40

# ENTARON XD/MD

## High-performance details

### 1 HOUSING

The three-part housing concept offers excellent flexibility for the positioning of the inlet in relation to the bracket. The use of plastic reinforced with glass fiber reduces the weight in comparison to conventional metal and hybrid air cleaners (combinations of metal and plastic) by more than 10 percent.

### 2 MAIN ELEMENT

The high-performance filter media achieves a long service life and separation efficiency above 99.99 percent. The support ring made from plastic, the center tube made from metal and the glue string technology ensure stability and safety during handling and operation. A version with a handle for even more user-friendly servicing is available as an option\*.

### 3 SECONDARY ELEMENT (OPTION)

The secondary element offers the highest possible security when servicing the main element. There are two variants available: The standard one is fitted with a non-woven element while the second variant can be fitted with a pleated cellulose element as an option for higher requirements with regard to flow resistance and separation efficiency.

### 4 MOUNTING POSSIBILITIES

Integrated mounting possibilities with through-holes (standard) and/or threaded inserts (on request) enable quick installation.

### 5 SERVICE SWITCH / INDICATOR

The ENTARON XD/MD series has a connection for a service switch/indicator integrated in the housing. The connection is designed not to take up installation space and is located in a protected position.

### 6 RELEASE AID\* AND SPECIAL FASTENERS

The smart design of the cover includes a release aid\* for the secondary element. The use of comfort fasteners prevents pinching between the cover and housing. The distinctive color-coding of the fastener caps is also easy to see when visibility is poor. Depending on the customer requirements, the fasteners can be positioned freely on the cover\*.

\*Only for ENTARON XD/MD

# ENTARON XD

## Part numbers and specifications

### PART NUMBERS

Model	Nominal flow rate [m <sup>3</sup> /min]	Raw air inlet position		Part number		Replacement filter element		Weight [kg]
				without secondary element	with secondary element	Main element	Secondary element	
ENTARON XD 14	7-14	left	1*	45 526 92 950	45 526 92 910	C 21 600	CF 1280	5.0
			2*	45 526 92 951	45 526 92 911			
			3*	45 526 92 952	45 526 92 912			
		right	4*	45 527 92 950	45 527 92 910			
			5*	45 527 92 951	45 527 92 911			
			6*	45 527 92 952	45 527 92 912			
ENTARON XD 17	9-17	left	1*	45 625 92 950	45 625 92 910	C 23 800	CF 1350	6.3
			2*	45 625 92 951	45 625 92 911			
			3*	45 625 92 952	45 625 92 912			
		right	4*	45 626 92 950	45 626 92 910			
			5*	45 626 92 951	45 626 92 911			
			6*	45 626 92 952	45 626 92 912			
ENTARON XD 21 <sup>1)</sup>	11-21	left	1*	45 722 92 950	45 722 92 910	C 25 900	CF 1470	7.3
			2*	45 722 92 951	45 722 92 911			
			3*	45 722 92 952	45 722 92 912			
		right	4*	45 723 92 950	45 723 92 910			
			5*	45 723 92 951	45 723 92 911			
			6*	45 723 92 952	45 723 92 912			
ENTARON XD 21-24 <sup>1)</sup>	11-21	left	1*	45 722 92 980	45 722 92 960	C 25 1020	CF 1480	7.9
			2*	45 722 92 981	45 722 92 961			
			3*	45 722 92 982	45 722 92 962			
		right	4*	45 723 92 980	45 723 92 960			
			5*	45 723 92 981	45 723 92 961			
			6*	45 723 92 982	45 723 92 962			
ENTARON XD 28 <sup>1)</sup>	14-28	left	1*	45 920 92 950	45 920 92 910	C 28 1300	CF 1750	9.6
			2*	45 920 92 951	45 920 92 911			
			3*	45 920 92 952	45 920 92 912			
		right	4*	45 921 92 950	45 921 92 910			
			5*	45 921 92 951	45 921 92 911			
			6*	45 921 92 952	45 921 92 912			
ENTARON XD 28-32 <sup>1)</sup>	14-28	left	1*	45 920 92 980	45 920 92 960	C 28 1460	CF 1760	10.1
			2*	45 920 92 981	45 920 92 961			
			3*	45 920 92 982	45 920 92 962			
		right	4*	45 921 92 980	45 921 92 960			
			5*	45 921 92 981	45 921 92 961			
			6*	45 921 92 982	45 921 92 962			
ENTARON XD 40	20-40	left	1*	45 930 92 950	45 930 92 910	C 35 2260	CF 21 160	18
			2*	45 930 92 951	45 930 92 911			
			3*	45 930 92 952	45 930 92 912			
		right	4*	45 931 92 950	45 931 92 910			
			5*	45 931 92 951	45 931 92 911			
			6*	45 931 92 952	45 931 92 912			

1) Successor generation to Europiclon 700 and Europiclon 800

\* Other spigot orientations possible on request.



# ENTARON XD

## Specifications

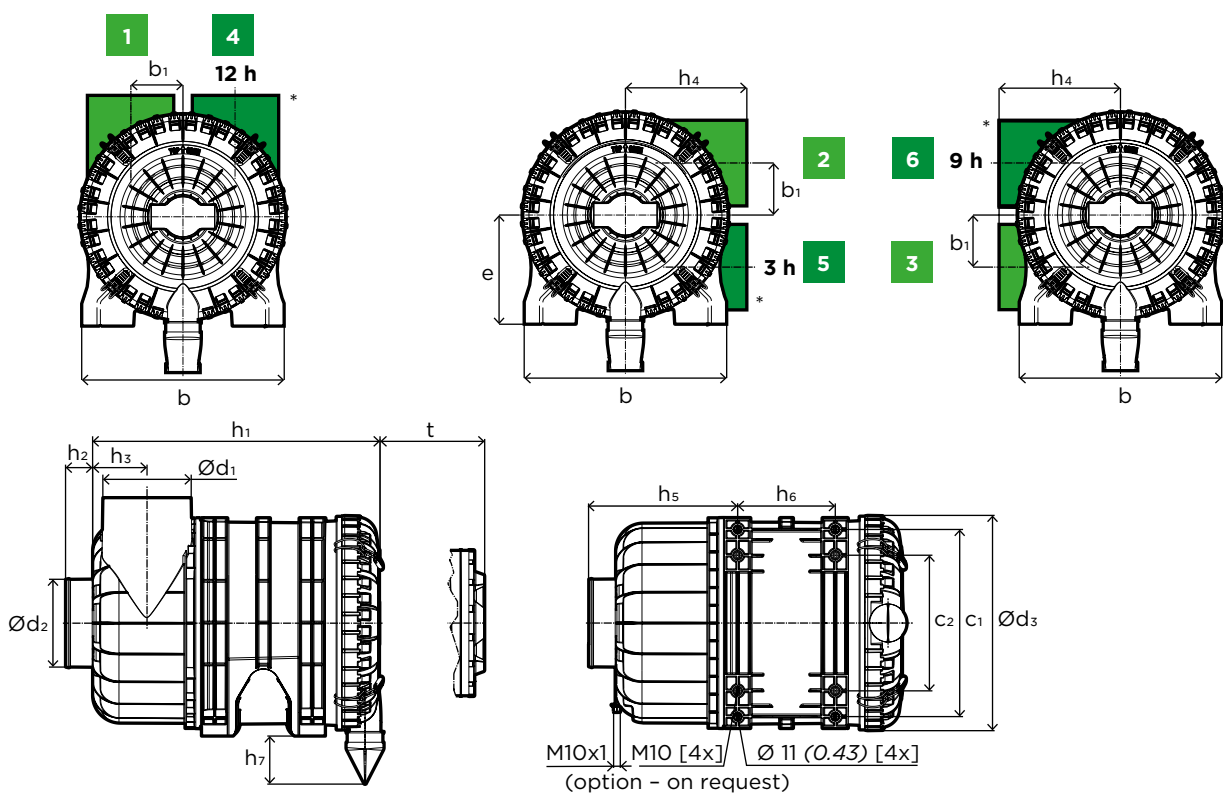

### DIMENSIONS

Model	Dimensions in mm (dimensions in inches)																
	b	b <sub>1</sub>	c <sub>1</sub>	c <sub>2</sub>	d <sub>1</sub>	d <sub>2</sub>	d <sub>3</sub>	e	h <sub>1</sub>	h <sub>2</sub>	h <sub>3</sub>	h <sub>4</sub>	h <sub>5</sub>	h <sub>6</sub>	h <sub>7</sub>	t	
<b>ENTARON XD 14</b>	300 (11.82)	79 (3.11)	263.3 (10.37)	175.3 (6.90)	130 (5.20)	110 (4.33)	305.7 (12.04)	159.7 (6.29)	422.9 (16.65)	45 (1.77)	72.8 (2.87)	186.5 (7.34)	218.4 (8.60)	136.8 (5.39)	85.8 (3.38)	362 (14.25)	
<b>ENTARON XD 17</b>	328.2 (12.92)	90.1 (3.55)	291.8 (11.92)	203.8 (8.03)	130 (5.20)	130 (5.20)	335.1 (13.19)	173.7 (6.84)	474.8 (18.70)	45 (1.77)	80.3 (3.16)	198 (7.80)	235.8 (9.29)	169.9 (6.69)	90.4 (3.56)	408 (16.06)	
<b>ENTARON XD 21</b>	357.8 (14.09)	92 (3.62)	320 (12.60)	232 (9.13)	150 (5.91)	150 (5.91)	368.9 (14.52)	193 (7.60)	491 (19.33)	45 (1.77)	90 (3.54)	215 (8.46)	254 (10)	167 (6.58)	82.1 (3.23)	426 (16.77)	
<b>ENTARON XD 21-24</b>	357.8 (14.09)	92 (3.62)	320 (12.60)	232 (9.13)	150 (5.91)	150 (5.91)	368.9 (14.52)	193 (7.60)	546 (21.50)	45 (1.77)	90 (3.54)	215 (8.46)	254 (10)	221.8 (8.73)	82.1 (3.23)	480 (18.90)	
<b>ENTARON XD 28</b>	388 (15.28)	96 (3.78)	354 (13.94)	266 (10.47)	180 (7.09)	180 (7.09)	398 (15.63)	208 (8.19)	572 (22.48)	45 (1.77)	105 (4.13)	245 (9.65)	283 (11.14)	220 (8.66)	80.7 (3.18)	505 (19.88)	
<b>ENTARON XD 28-32</b>	388 (15.28)	96 (3.78)	354 (13.94)	266 (10.47)	180 (7.09)	180 (7.09)	398 (15.63)	208 (8.19)	638 (25.12)	45 (1.77)	105 (4.13)	245 (9.65)	283 (11.14)	285 (11.22)	80.7 (3.18)	573 (22.56)	
<b>ENTARON XD 40</b>	477 (18.78)	125.7 (4.95)	439 (17.28)	351 (13.82)	210 (8.27)	203 (7.99)	486.1 (19.14)	248 (9.76)	638.4 (25.13)	65 (2.56)	116.1 (4.57)	295.5 (11.63)	331.6 (13.06)	239.1 (9.41)	218 (8.58)	650 (25.59)	

\* Mirror image version of the raw air inlet.

# ENTARON MD 40

## Part numbers and specifications

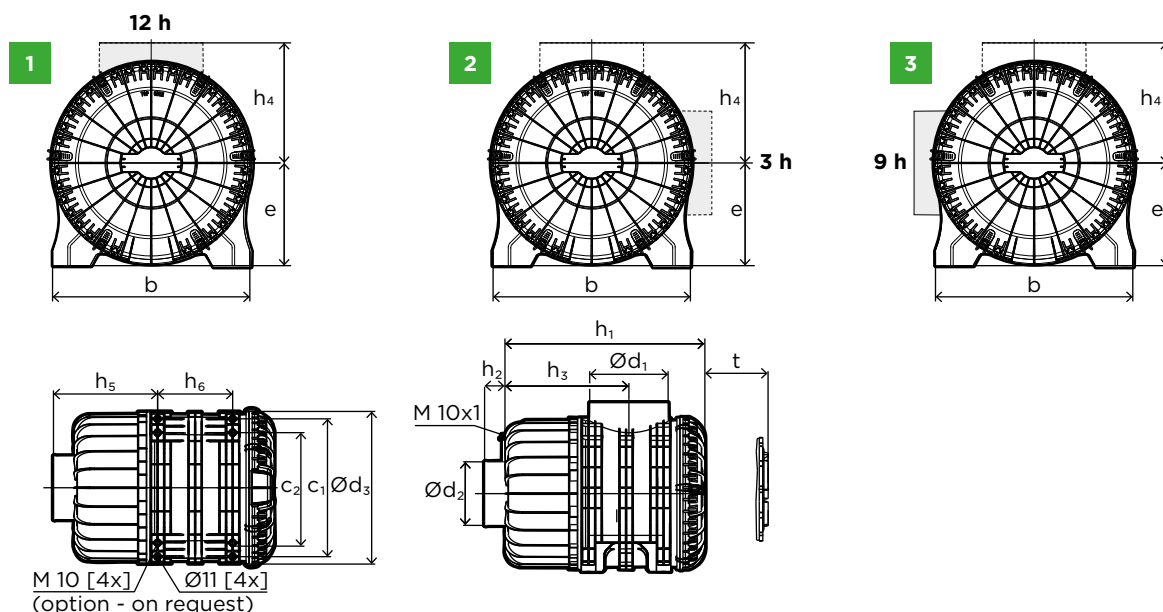

### PART NUMBERS

Model	Nominal flow rate [m <sup>3</sup> /min]	Raw air inlet position	Part number		Replacement filter element		Weight [kg]	
			without secondary element	with secondary element	Main element <sup>1)</sup>	Secondary element <sup>2)</sup>		
ENTARON MD 40	20-40	central	1	45 932 72 980	45 932 72 960	C 38 3062	CF 21 160	18
			2	45 932 72 981	45 932 72 961			
			3	45 932 72 982	45 932 72 962			

### DIMENSIONS

Model	Dimensions in mm (dimensions in inches)													
	b	c <sub>1</sub>	c <sub>2</sub>	d <sub>1</sub>	d <sub>2</sub>	d <sub>3</sub>	e	h <sub>1</sub>	h <sub>2</sub>	h <sub>3</sub>	h <sub>4</sub>	h <sub>5</sub>	h <sub>6</sub>	t
ENTARON MD 40	476.5 (18.76)	439 (17.28)	361.5 (14.23)	250 (9.84)	203 (7.99)	486.1 (19.14)	248 (9.76)	638.4 (25.13)	65 (2.56)	395.2 (15.56)	290 (11.42)	331.6 (13.06)	239.1 (9.41)	650 (25.59)

### SPECIFICATIONS

Model	Housing material	Dust discharge connection diameter	Tightening torque			Operating temperature		Discharge valve orientation (downwards)
			Hose clamp (clean side)	Threaded insert	Through-hole	Continuous	Short-term	
ENTARON XD	PP-GF30	54 mm (2.13 inch)	max. 5 Nm	15 Nm	23 Nm	-30 °C to +90 °C	+110 °C	±15°
ENTARON XD 40		74 mm (2.91 inch)						
ENTARON MD 40		-				-	-	

1) On request available with handle as option.

2) On request secondary element available with cellulose media.

# DualSpin XT Specifications

**THE DUALSPIN XT PRE-SEPARATOR IS THE PERFECT ADDITION TO THE ENTARON MD 40.**

## ADVANTAGES

- High separation performance with low pressure drop
- As combination air cleaner considerably longer service life than comparable solutions on the market
- Flexible installation through operation with scavenging
- Installation possible in every direction in relation to scavenging connection
- Less downtime
- Robust design

## PART NUMBERS

Model	Suitable for	Part number
DualSpin XT	ENTARON MD 40	48 030 75 910

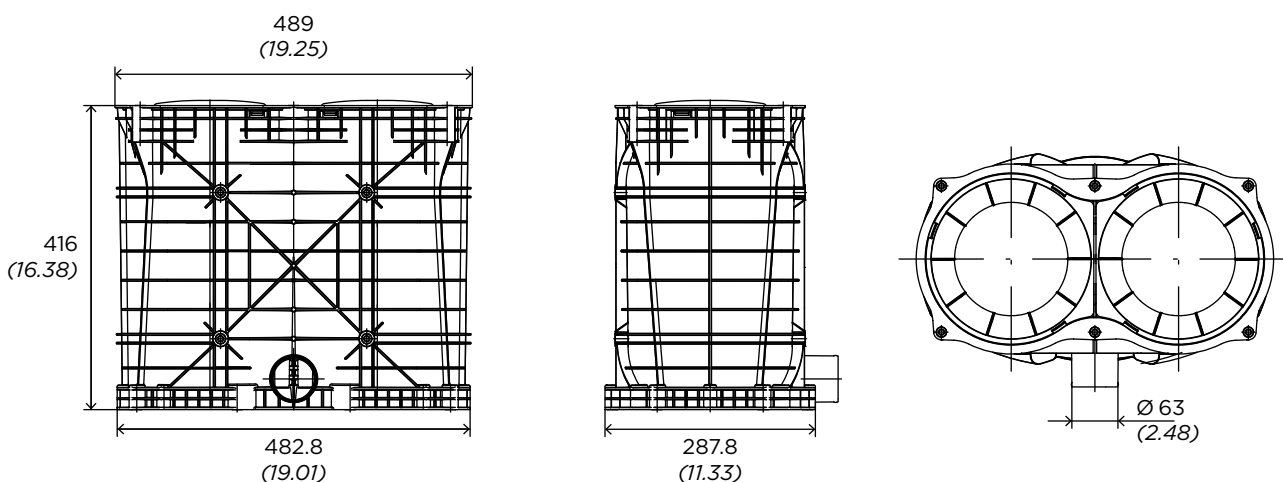

The connecting piece between ENTARON MD 40 and DualSpin XT is not included in the MANN+HUMMEL scope of delivery.

As an option, the ENTARON MD 40 can be used with an external DualSpin 37 pre-separator (with valve or scavenging operation), see catalog page 83.

# ENTARON XD

## Flow characteristics

### ENTARON XD 14

Flow rate

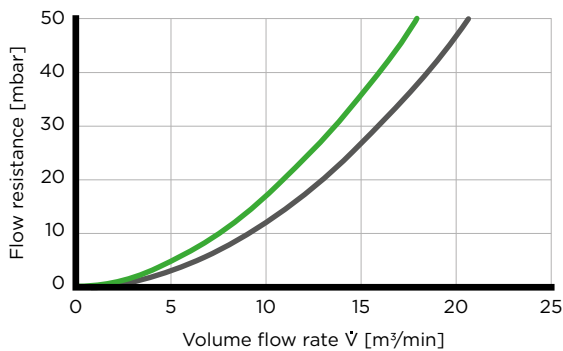

### ENTARON XD 14

Dust capacity

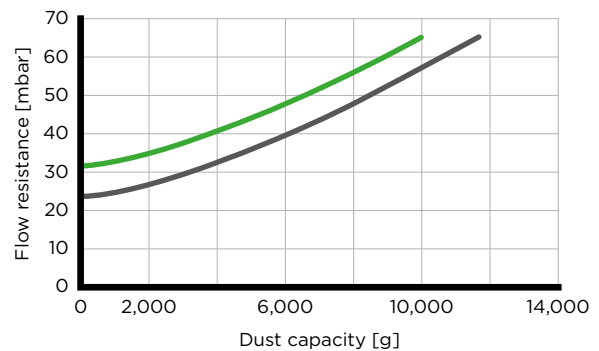

### ENTARON XD 17

Flow rate

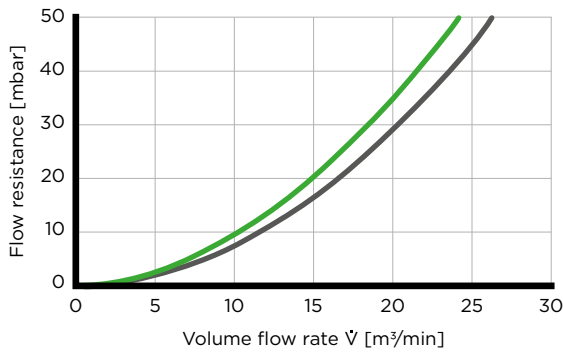

### ENTARON XD 17

Dust capacity

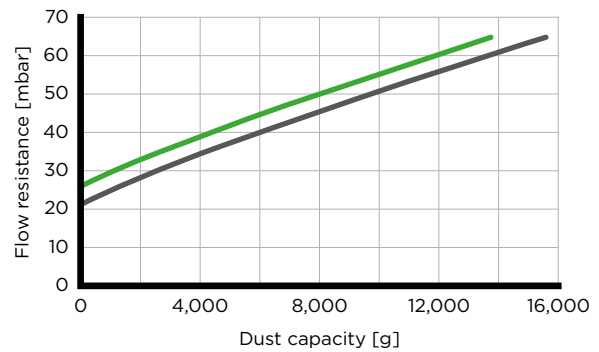

### ENTARON XD 21

Flow rate

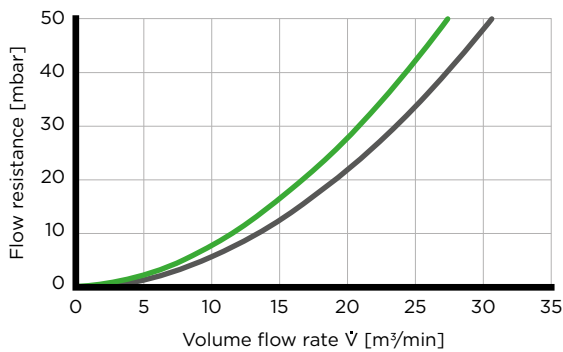

### ENTARON XD 21

Dust capacity

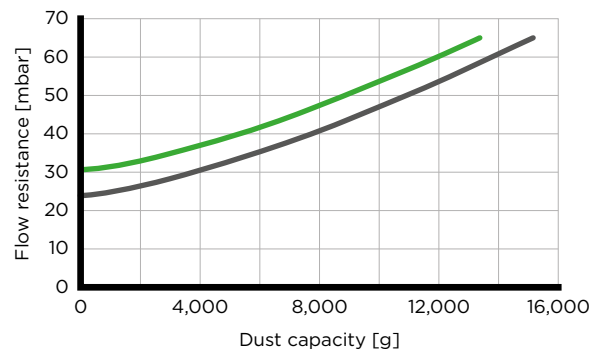

■ With secondary element ■ Without secondary element

Data with scavenging on request.

Flow characteristics measured according to ISO 5011 with ISO coarse at nominal flow rates according to the specifications.

# ENTARON XD

## Flow characteristics

### ENTARON XD 21-24

Flow rate

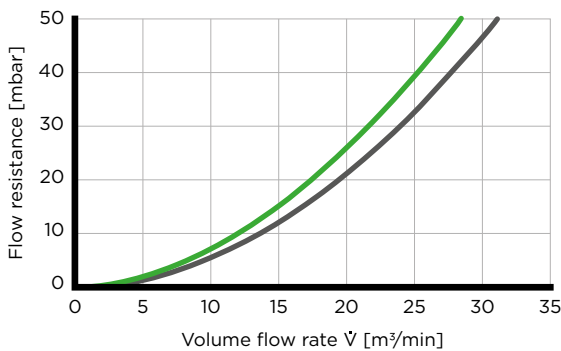

### ENTARON XD 21-24

Dust capacity

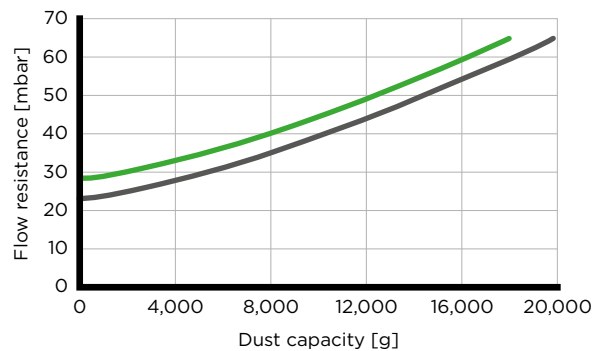

### ENTARON XD 28

Flow rate

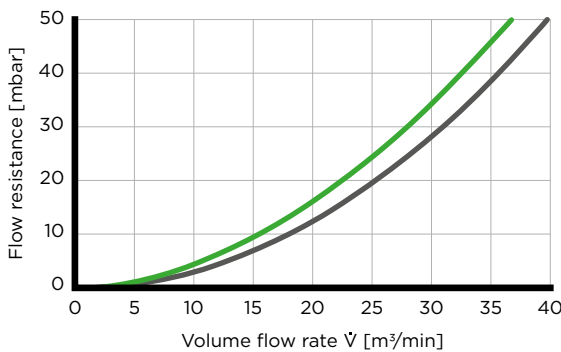

### ENTARON XD 28

Dust capacity

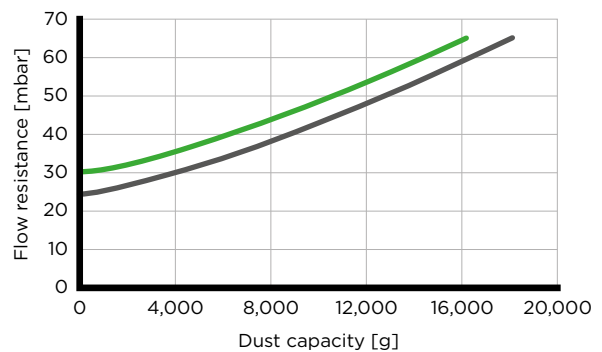

### ENTARON XD 28-32

Flow rate

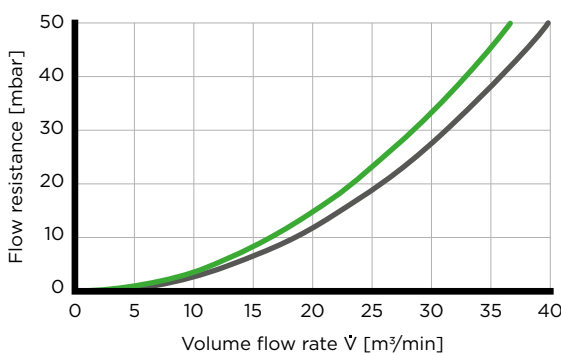

### ENTARON XD 28-32

Dust capacity

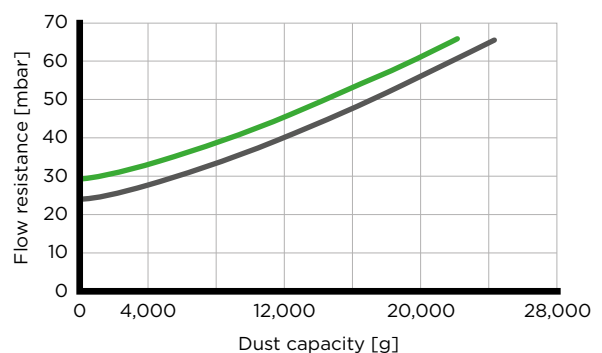

■ With secondary element ■ Without secondary element

Data with scavenging on request.

Flow characteristics measured according to ISO 5011 with ISO coarse at nominal flow rates according to the specifications.

# ENTARON XD/MD

## Flow characteristics

### ENTARON XD 40

Flow rate

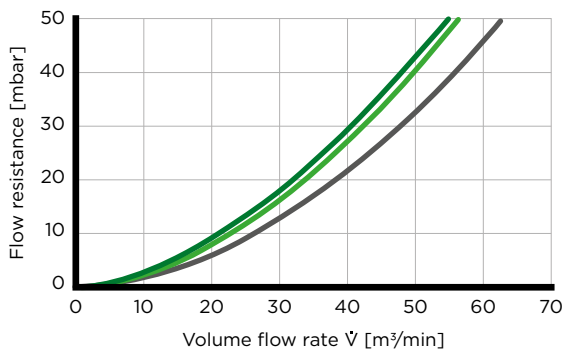

### ENTARON XD 40

Dust capacity

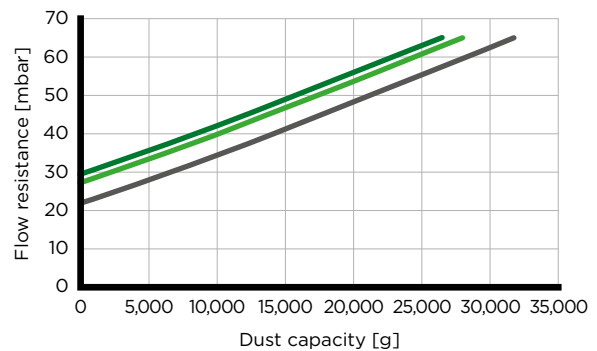

### ENTARON MD 40

Flow rate

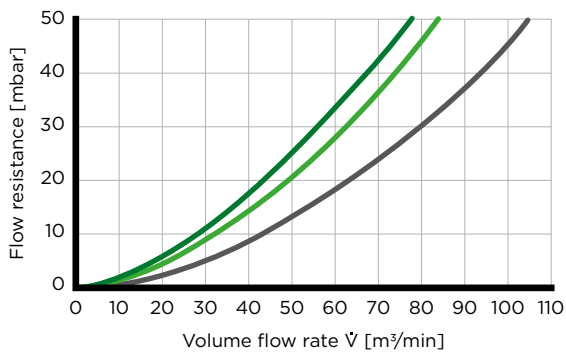

### ENTARON MD 40

Dust capacity

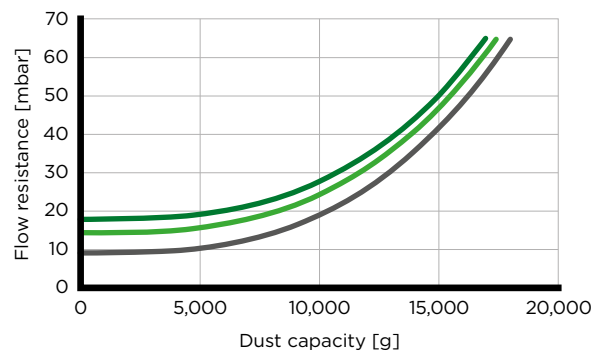

- With secondary element made from cellulose material
- With secondary element made from non-woven material
- Without secondary element

Data with scavenging on request.

Flow characteristics measured according to ISO 5011 with ISO coarse at nominal flow rates according to the specifications.

# ENTARON XD/MD

## Spare parts and accessories



### SPARE PARTS

Model	Part number			Replacement filter element		
	Dust discharge valve		Cover	Main element	Secondary element	
	short version <sup>2)</sup>	long version			Non-woven element	Cellulose element
<b>ENTARON XD 14</b>	39 000 40 731	-	45 526 17 909	C 21 600	CF 1280	-
<b>ENTARON XD 17</b>	39 000 40 731	-	45 625 17 909	C 23 800	CF 1350	-
<b>ENTARON XD 21</b>	39 000 40 731	-	45 722 17 909	C 25 900	CF 1470	-
<b>ENTARON XD 21-24</b>	39 000 40 731	-	45 722 17 919	C 25 1020	CF 1480	-
<b>ENTARON XD 28</b>	39 000 40 731	-	45 920 17 909	C 28 1300	CF 1750	-
<b>ENTARON XD 28-32</b>	39 000 40 731	-	45 920 17 919	C 28 1460	CF 1760	-
<b>ENTARON XD 40</b>	39 000 40 291	39 000 40 991	45 930 17 909	C 35 2260	CF 21 160	CF 21 160/1
<b>ENTARON MD 40</b>	-	-	45 932 17 909	C 38 3062 <sup>1)</sup>	CF 21 160	CF 21 160/1

1) On request available with handle as option.

2) Part number for angled dust discharge valve with elbow: 39 000 40 671.

### ACCESSORIES

Model	Rain cap (page 134)	Straight connection (page 139)		90 degree elbow (page 138)	
	Form A	Without connection	With connection for M 10x1	Without connection	With connection for M 10x1
<b>ENTARON XD 14</b>	39 160 67 910	39 600 27 999	39 600 27 979	39 600 25 999	39 600 25 979
<b>ENTARON XD 17</b>	39 160 67 910	39 700 27 999	39 700 27 979	39 700 25 999	39 700 25 979
<b>ENTARON XD 21</b>	39 190 67 910	39 800 27 999	39 800 27 979	39 800 25 999	39 800 25 979
<b>ENTARON XD 21-24</b>	39 190 67 910	39 800 27 999	39 800 27 979	39 800 25 999	39 800 25 979
<b>ENTARON XD 28</b>	39 220 67 910	39 930 27 999	39 930 27 979	39 930 25 999	39 930 25 979
<b>ENTARON XD 28-32</b>	39 220 67 910	39 930 27 999	39 930 27 979	39 930 25 999	39 930 25 979
<b>ENTARON XD 40</b>	39 370 67 910	39 000 27 345	-	39 000 25 270	-
<b>ENTARON MD 40</b>	39 420 67 910	39 000 27 345	-	39 000 25 270	-





# ENTARON HD/CD

## Round air cleaner for excellent flexibility

The compact ENTARON HD two-stage air cleaner is roughly one third smaller than comparable air cleaners with a similar filtration performance and is therefore one of the smallest air cleaners in its class. In the long term MANN+HUMMEL will replace the proven Europiclon with this range.

The ENTARON CD is designed as a single-stage alternative to the ENTARON HD and is therefore the preferred solution for stationary applications with a low to medium dust load (e.g. compressors and power generators). In comparison to the Europiclon the installation space can be significantly reduced retaining the same low flow resistance.

### ADVANTAGES

- Easy installation and compact design – up to 30 percent (ENTARON HD) or 50 percent (ENTARON CD) smaller than air cleaners with a comparable filtration performance
- Increased engine protection through increased initial and final separation efficiencies
- New type of sealing concept for reliable operation
- Environmentally-friendly and economical disposal through filter elements which are metal-free and fully incinerable
- Cr(VI)-free components
- Tool-less servicing due to comfort fasteners

### ENTARON HD

- Long service life
- High pre-separation efficiency due to integrated tangential inflow (no external pre-separator required)
- Easy operation with dust discharge valve
- Customized variants easy to generate
- Mirror image version for raw air inlet available

### ENTARON CD

- Low flow resistance reduces operating costs
- Housing air cleaner with free intake (no air duct on the raw air side required)
- Reduced installation costs due to axial air intake via the cover

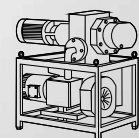
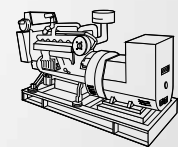
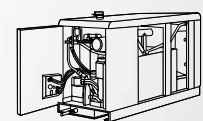
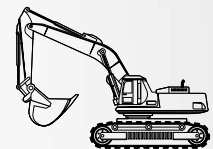

# ENTARON HD/CD

## Round air cleaner for excellent flexibility

### THE BEST CHOICE FOR EACH APPLICATION

The ENTARON HD and CD air cleaners enable a perfect solution for each application. The ENTARON HD two-stage air cleaner is particularly suitable for applications with high dust loads. The single-stage ENTARON CD with low flow resistance and reduced operating costs is suitable for low to medium dust loads. Another benefit of the ENTARON CD is the simplified installation of the air cleaner on the raw air side which does not require any ducts. In addition, the ENTARON HD 4 VAC is available for vacuum pumps on request.

Both air cleaner versions offer a high filtration performance and compact design. The housing concept consists of three plastic parts: A special welding process reliably joins the raw air inlet to the air cleaner body. The gasket inserted in the cover protects against ingress of water and prevents the entry of hot intake air from the engine compartment to enable a reliable function. The innovative housing concept allows adaptation of the air cleaner to almost all installation situations as practically all orientations of the inlet duct relative to the integrated brackets are possible. The fixing of the air cleaner can be made using through-holes or threaded inserts. Additional flexibility is provided by the possibility to configure the raw air inlet in a mirror image position and also a selection of welded clean air connections comprising a 90 degree elbow which can be positioned (depending on model), a MAF connection and inch and metric connections.

### INNOVATIVE EVOLUTION

The ENTARON HD achieves excellent separation efficiencies due to effective pre-separation through tangential air flow and optimum filtration with high-performance media. This is despite the fact that the air cleaner requires only small installation space. In comparison to air cleaners with a similar filtration performance the air cleaner is approximately 30 percent smaller and is therefore one of the most compact air cleaners in its class. This is made possible by its design and ingenious solutions such as the integrated and protected service connection which requires less installation space.

### PERFECT CONTROL

The right relation between the volume of air and fuel is crucial for an environmentally-friendly combustion process and economical engine operation. The ENTARON HD is well prepared for an MAF sensor. In order to ensure the best signal quality at all times, the secondary element is equipped with a key lock function which defines the installation position and therefore the right air flow.

# ENTARON HD/CD

## At a glance



Technical features	ENTARON HD	ENTARON CD
<b>Type of operation</b>	Two-stage air cleaner	Single-stage air cleaner
<b>Field of application</b>	Mobile applications with high dust loads such as construction and agricultural machines and compressors	Stationary applications in areas with a low dust load such as machines and engines, gensets and compressors
<b>Air flow requirements</b>	2-13 m <sup>3</sup> /min	2-13 m <sup>3</sup> /min
<b>Pre-separator</b>	Tangential	-
<b>Pre-separation efficiency</b>		
■ With dust discharge valve	> 86%	-
■ With scavenging (5%)	> 89%	-
<b>Final separation efficiency</b>	> 99.99%	> 99.97%
<b>Dust discharge</b>	Dust discharge valve (option: scavenging)	-
<b>Secondary element</b>	Option	-
<b>Installation</b>	Vertical and horizontal installation possible <sup>1)</sup>	Vertical and horizontal installation possible
<b>Servicing concept</b>	Front servicing with comfort fasteners <sup>2)</sup>	Front servicing with comfort fasteners
<b>Additional protection against ingress of water</b>	Standard	-
<b>Special variant</b>	Vacuum versions <sup>3)</sup>	-

1) Depends on the position of the dust discharge valve (valve always directed downwards).

2) Except ENTARON HD 13 (standard fasteners).

3) On request.

# ENTARON HD/CD

## High-performance details

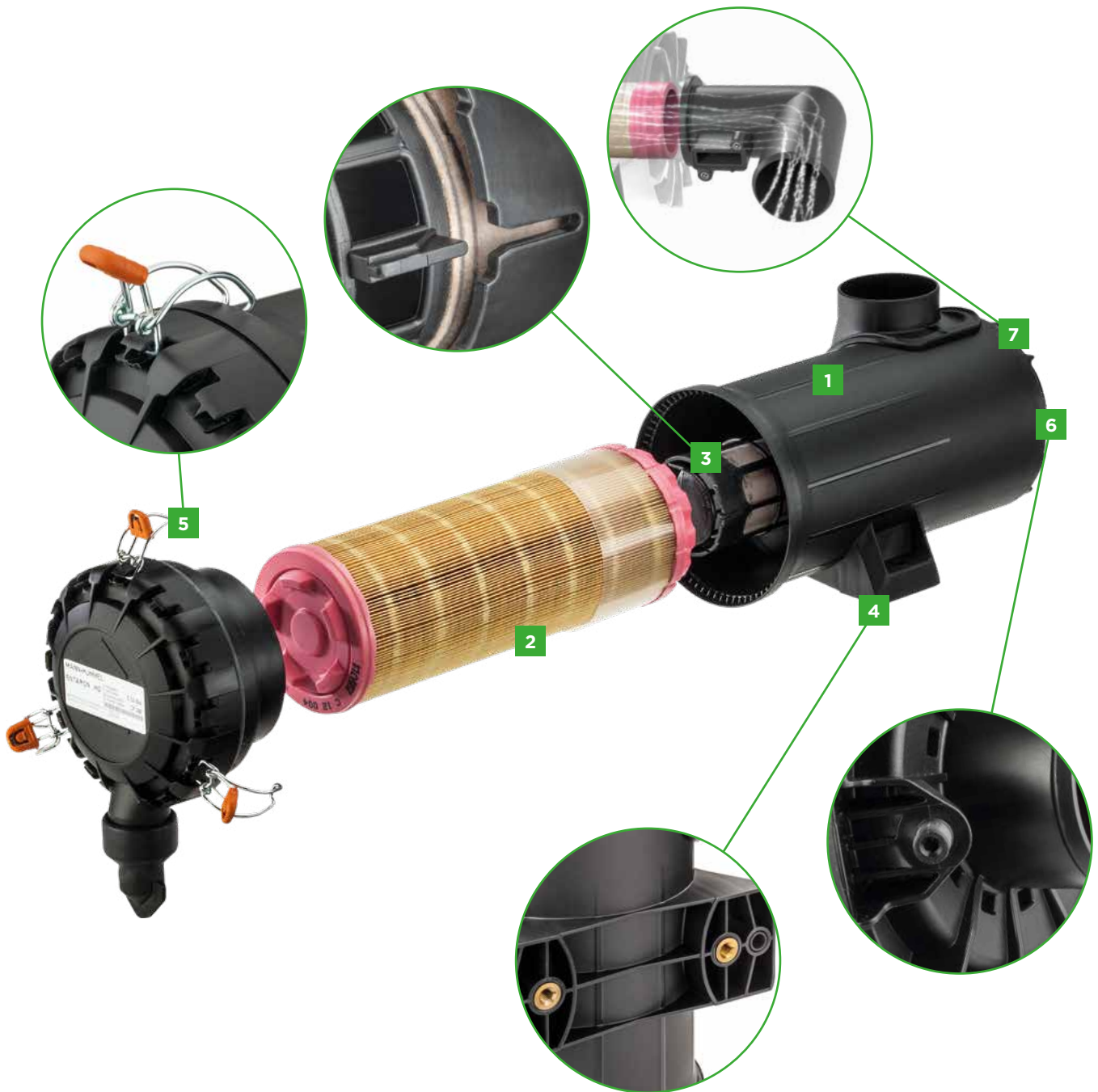

# ENTARON HD/CD

## High-performance details

### 1 HOUSING

The three-part housing concept offers excellent flexibility for the positioning of the inlet angle relative to the integrated bracket and therefore simplifies use for OEM applications.

### 2 MAIN ELEMENT

The innovative filter media offers a high separation performance simultaneously with an exceptionally long service life. The filter element is equipped with a new gasket system which ensures the reliable sealing of the element to the housing. The main and secondary elements are metal free and are fully incinerable with low-cost disposal.

### 3 SECONDARY ELEMENT

The center tube of the ENTARON HD fixed to the housing protects the secondary element, defines the installation position and prevents unintentional removal or incorrect installation.

### 4 MOUNTING POSSIBILITIES

The brackets integrated in the housing (on request also available without brackets for HD 10 and 13) offer two mounting possibilities with through-holes (as standard with M8 screws) and threaded inserts\*.

### 5 COMFORT FASTENERS

During servicing the snap-in function of the comfort fasteners prevents pinching between the cover and housing. The distinctive color-coding of the fasteners enables a reliable service even when visibility is poor. In order to meet special installation conditions, the fasteners can be freely positioned on the cover according to the customer needs.

### 6 SERVICE SWITCH

The ENTARON HD/CD has a connection for a service indicator which is directly integrated in the housing. The connection is designed to use a minimum of installation space and is located in a protected position.

### 7 PREPARED FOR MAF SENSOR TECHNOLOGY

Due to the defined installation position of the secondary element and optional welded clean air outlet, the ENTARON HD is perfectly designed for a MAF sensor with excellent signal quality.

\* Option - on request.

# ENTARON HD/CD

## Part numbers and specifications

### PART NUMBERS

Model	Nominal flow rate [m <sup>3</sup> /min]	Raw air inlet position		Part number		Replacement filter element		Weight [kg]
				without secondary element	with secondary element	Main element	Secondary element	
ENTARON HD 4	2-4	left	1*	45 131 92 950	45 131 92 910	C 12 004	CF 240	1.4
			2*	45 131 92 951	45 131 92 911			
			3*	45 131 92 952	45 131 92 912			
		right	4*	45 132 92 950	45 132 92 910			
			5*	45 132 92 951	45 132 92 911			
			6*	45 132 92 952	45 132 92 912			
ENTARON HD 5.5	3-5.5	left	1*	45 151 92 950	45 151 92 910	C 13 009	CF 355	1.7
			2*	45 151 92 951	45 151 92 911			
			3*	45 151 92 952	45 151 92 912			
		right	4*	45 152 92 950	45 152 92 910			
			5*	45 152 92 951	45 152 92 911			
			6*	45 152 92 952	45 152 92 912			
ENTARON HD 7.5	4-7.5	left	1*	45 171 92 950	45 171 92 910	C 15 020	CF 475	2.2
			2*	45 171 92 951	45 171 92 911			
			3*	45 171 92 952	45 171 92 912			
		right	4*	45 172 92 950	45 172 92 910			
			5*	45 172 92 951	45 172 92 911			
			6*	45 172 92 952	45 172 92 912			
ENTARON HD 10	5-10	left	1*	45 191 92 950	45 191 92 910	C 16 100	CF 510	3.1
			2*	45 191 92 951	45 191 92 911			
			3*	45 191 92 952	45 191 92 912			
		right	4*	45 192 92 950	45 192 92 910			
			5*	45 192 92 951	45 192 92 911			
			6*	45 192 92 952	45 192 92 912			
ENTARON HD 13	7.5-13	left	1*	45 231 92 950	45 231 92 910	C 19 130	CF 613	3.8
			2*	45 231 92 951	45 231 92 911			
			3*	45 231 92 952	45 231 92 912			
		right	4*	45 232 92 950	45 232 92 910			
			5*	45 232 92 951	45 232 92 911			
			6*	45 232 92 952	45 232 92 912			
ENTARON CD 4	2-13	position-independent	45 131 85 990	-	C 12 014	-	1.2	

\* Other spigot orientations possible on request

### SPECIFICATIONS

Model	Housing material	Dust discharge connection diameter	Tightening torque			Operating temperature		Discharge valve orientation (downwards)
			Hose clamp (clean side)	Threaded insert	Through-hole	Continuous	Short-term	
ENTARON HD 4 to 7.5	PP-T20	40 mm (1.57 inch)	max. 5 Nm	max. 25 Nm	max. 25 Nm	-30 °C to +80 °C	+110 °C	±15 °
ENTARON HD 10 to 13		54 mm (2.13 inch)						
ENTARON CD 4		-						

# ENTARON HD/CD

## Specifications

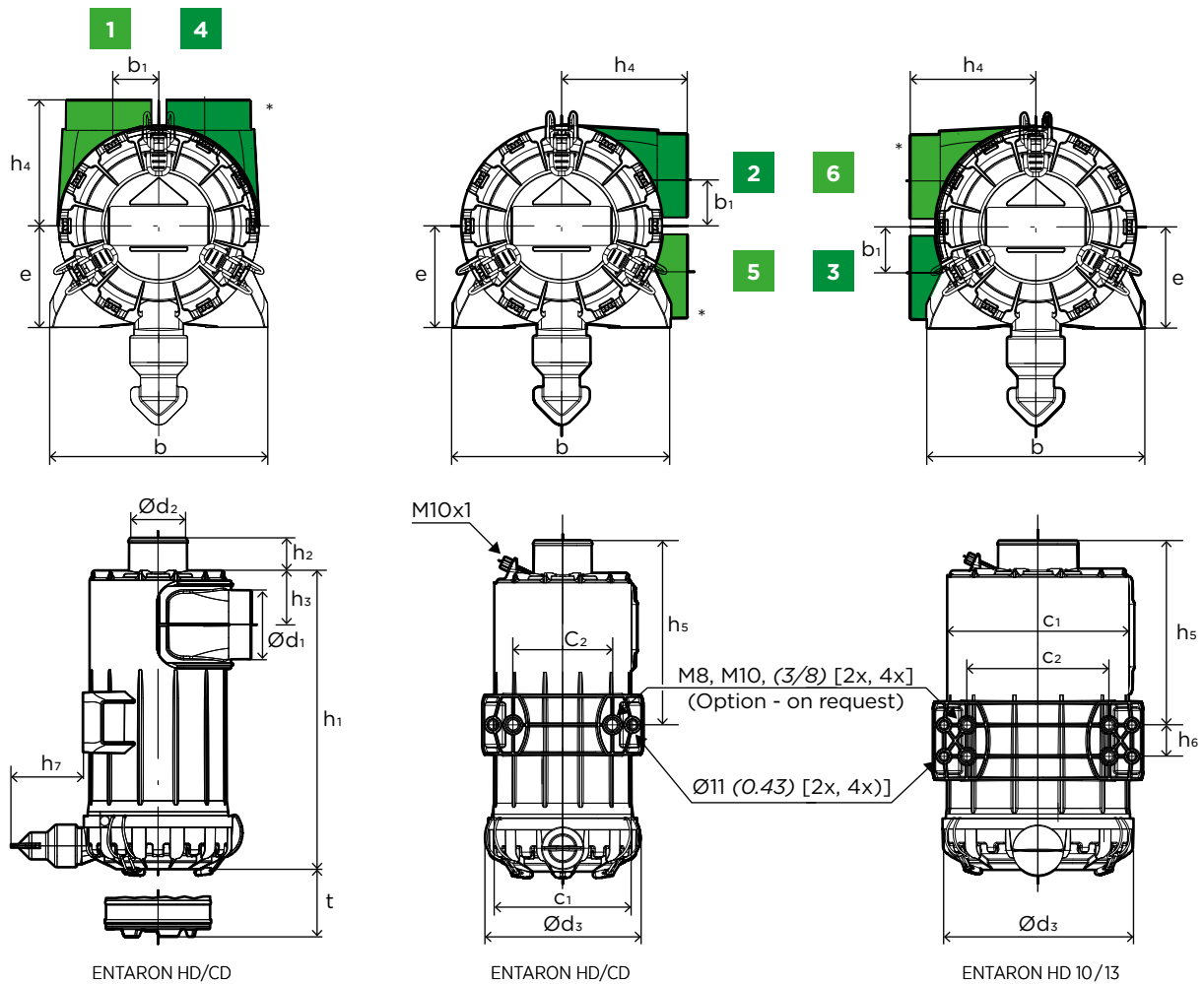

### DIMENSIONS

Model	Dimensions in mm (dimensions in inches)															
	b	b <sub>1</sub>	c <sub>1</sub>	c <sub>2</sub>	d <sub>1</sub>	d <sub>2</sub>	d <sub>3</sub>	e	h <sub>1</sub>	h <sub>2</sub>	h <sub>3</sub>	h <sub>4</sub>	h <sub>5</sub>	h <sub>6</sub>	h <sub>7</sub>	t
ENTARON HD 4	178 (7.01)	37.5 (1.48)	154 (6.07)	110 (4.33)	76 (2.99)	64 (2.52)	164 (6.46)	83 (3.27)	330 (13.00)	36 (1.42)	60 (2.36)	103 (4.06)	204 (8.04)	-	80 (3.15)	300 (11.82)
ENTARON HD 5.5	193 (7.60)	40 (1.58)	165 (6.50)	110 (4.33)	90 (3.55)	76 (2.99)	189 (7.45)	95.5 (3.76)	340 (13.40)	36 (1.42)	68 (2.68)	118 (4.65)	212 (8.35)	-	80 (3.15)	310 (12.21)
ENTARON HD 7.5	230 (9.06)	46 (1.81)	190 (7.49)	127 (5.00)	102 (4.02)	89 (3.51)	216 (8.51)	109 (4.29)	360 (14.18)	36 (1.42)	74 (2.92)	131 (5.16)	221 (8.71)	-	80 (3.15)	330 (13.00)
ENTARON HD 10	268.6 (10.58)	51 (2.01)	240 (9.46)	182 (7.17)	130 (5.12)	102 (4.02)	244 (9.61)	123 (4.85)	385 (15.17)	36 (1.42)	85.5 (3.37)	143 (5.63)	236 (9.30)	40 (1.58)	90 (3.55)	355 (13.99)
ENTARON HD 13	290.6 (11.48)	45.5 (1.79)	262 (10.3)	204 (8.10)	150 (5.92)	110 (4.34)	278 (10.91)	140 (5.49)	414 (16.36)	37 (1.42)	97 (3.82)	166 (6.51)	258 (10.15)	40 (1.58)	90 (3.55)	385 (15.21)
ENTARON CD 4	178 (7.01)	-	154 (6.07)	110 (4.33)	-	64 (2.52)	164 (6.46)	83 (3.27)	330 (13.00)	36 (1.42)	-	-	204 (8.04)	-	-	300 (11.82)

\* Mirror image version of the raw air inlet.

# ENTARON HD/CD

## Flow characteristics

### ENTARON HD 4

Flow rate

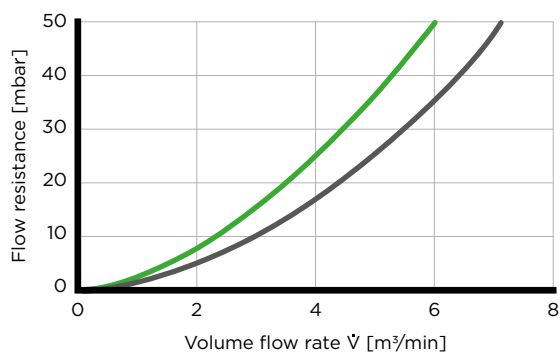

### ENTARON HD 4

Dust capacity

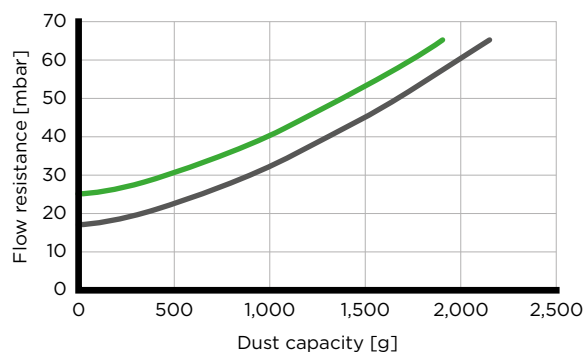

### ENTARON HD 5.5

Flow rate

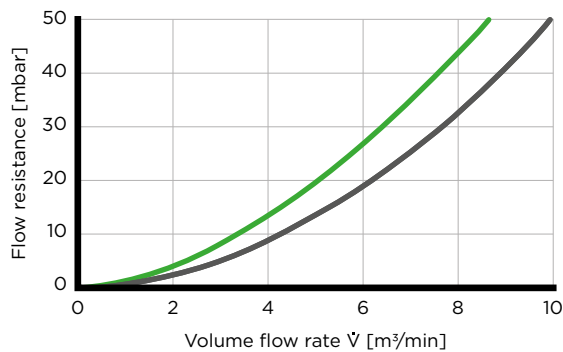

### ENTARON HD 5.5

Dust capacity

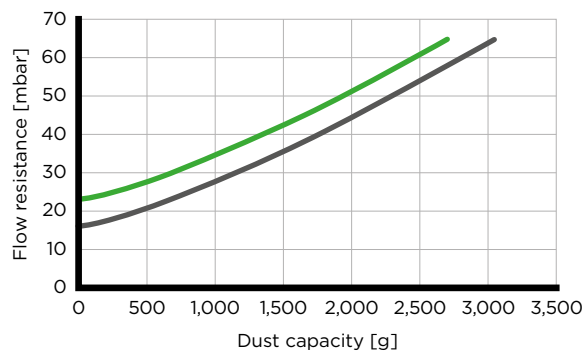

### ENTARON HD 7.5

Flow rate

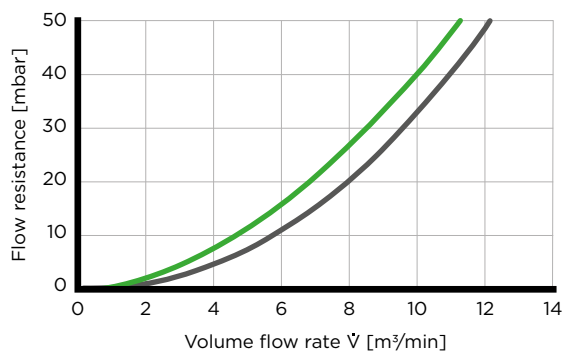

### ENTARON HD 7.5

Dust capacity

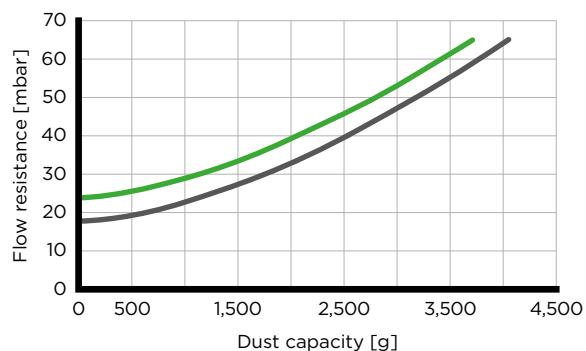

■ With secondary element ■ Without secondary element

Data with scavenging on request.

Flow characteristics measured according to ISO 5011 with ISO coarse at nominal flow rates according to the specifications.



# ENTARON HD/CD

## Flow characteristics

### ENTARON HD 10

Flow rate

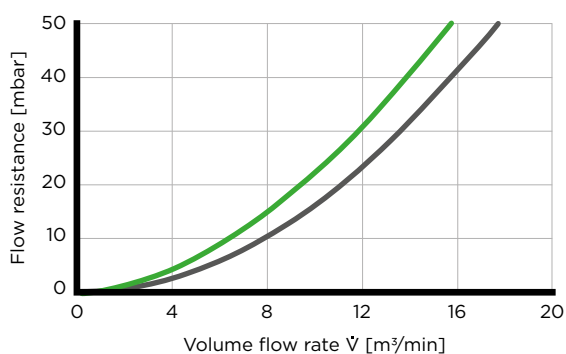

### ENTARON HD 10

Dust capacity

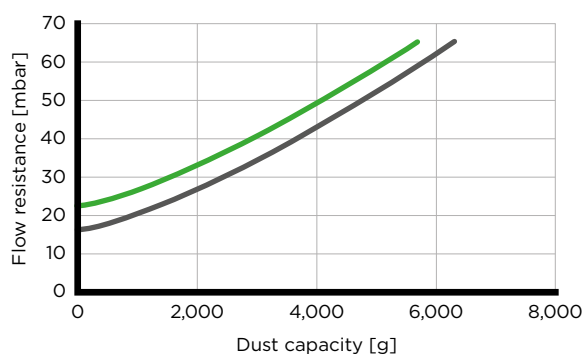

### ENTARON HD 13 (preliminary)

Flow rate

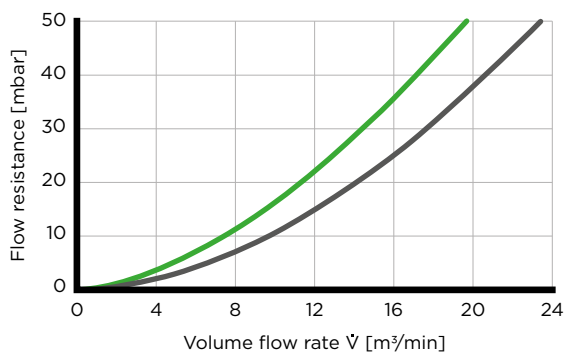

### ENTARON HD 13 (preliminary)

Dust capacity

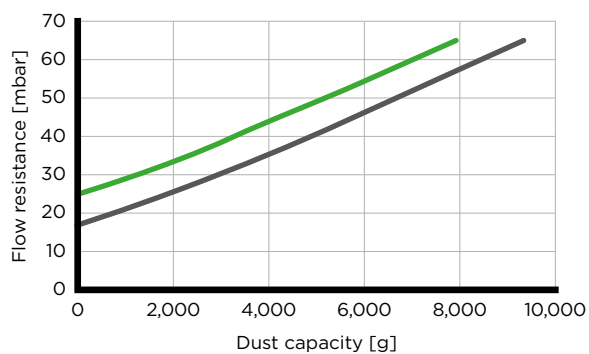

### ENTARON CD 4 (preliminary)

Flow rate

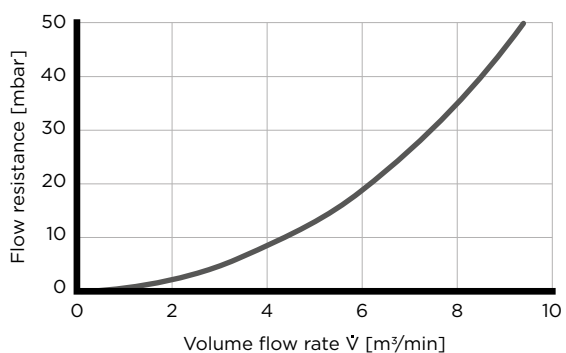

### ENTARON CD 4 (preliminary)

Dust capacity

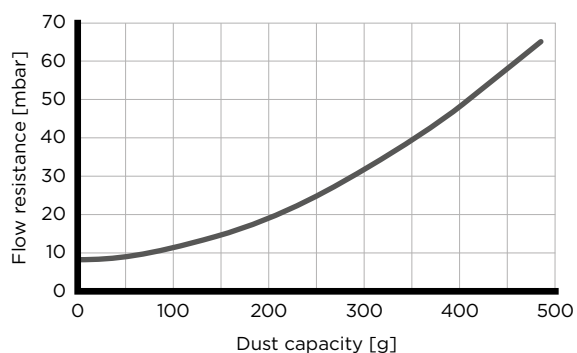

■ With secondary element ■ Without secondary element

Data with scavenging on request.

Flow characteristics measured according to ISO 5011 with ISO coarse at nominal flow rates according to the specifications.

# ENTARON HD/CD

## Spare parts and accessories



### SPARE PARTS

Model	Part number	Replacement filter element	
	Part number	Main element	Secondary element
ENTARON HD 4	45 131 17 909	C 12 004	CF 240
ENTARON HD 5.5	45 151 17 909	C 13 009	CF 355
ENTARON HD 7.5	45 171 17 909	C 15 020	CF 475
ENTARON HD 10	45 191 17 909	C 16 100	CF 510
ENTARON HD 13	45 231 17 119	C 19 130	CF 613
ENTARON CD 4	13 951 60 S01	C 12 014	-

### DUST DISCHARGE VALVE

Model	Dust discharge connection diameter	Replacement filter element		
		Dust discharge valve small, standard	Dust discharge valve large/angled	Dust discharge valve large/straight
ENTARON HD 4	40 mm	39 000 40 391	39 000 40 661	39 000 40 102
ENTARON HD 5.5	40 mm	39 000 40 391	39 000 40 661	39 000 40 102
ENTARON HD 7.5	40 mm	39 000 40 391	39 000 40 661	39 000 40 102
ENTARON HD 10	54 mm	39 000 40 731	-	-
ENTARON HD 13	54 mm	39 000 40 731	-	-
ENTARON CD 4	-	-	-	-



#### NOTE

The complete range of accessories for our air cleaners can be found starting on page 132.





# NLG series

## Modular system for multiple applications

The NLG series developed by MANN+HUMMEL is an economic solution for the filtration of intake air in numerous applications. The flexibility of the series is achieved by a variable modular system. The NLG Pico single stage air cleaner is designed for applications with a low dust load while the NLG Piclon version with integrated dust pre-separation is used for applications with a medium dust load. Our combination air cleaner with separate DualSpin pre-separator is designed for highest dust loads.

### ADVANTAGES

- Corrosion-free and robust housing through use of plastic reinforced with glass fiber
- Environmentally-friendly and economical disposal through filter elements which are metal-free and fully incinerable
- Cr(VI)-free components
- Easy adaptation to different devices through variable inlet positions
- Quick initial installation on vehicle through integrated threaded inserts
- Standard wire clamp fasteners for easy change of the filter element without the need for tools

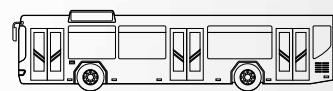
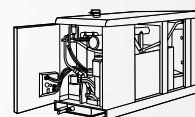

# NLG series

## Modular system for multiple applications

### MODULAR SYSTEM FOR EXCELLENT FLEXIBILITY

Flexibility makes the air cleaners of the NLG series suitable for multiple applications. The modular design of the series and different variations always enable an economic solution. The NLG modular system offers four different air cleaner diameters which can each be combined with three different housing lengths to generate 12 basic variants. These variants allow the application to perfectly adapt to the respective requirements of the local environment. Usually, for the standard version of a machine, an NLG with a short housing and short elements is sufficient. If the dust load increases to the medium level, a longer housing and longer elements can be used. The tool-less element service and the standard duct connections and mounting of the air cleaner bracket enable easy and uncomplicated replacement.

### PERFECT FOR EXTREME CONDITIONS

The DualSpin pre-separator option is the right choice for extreme operating conditions. The pre-separator perfectly matches the NLG Pico air cleaner and offers a separation efficiency above 84 percent. The special arrangement of both guiding vanes reduces pressure drop in comparison to the use of an NLG Piclon. The robust housing of the pre-separator is particularly suitable for the separation of organic particles and consists of antistatic plastic. This makes the DualSpin ideal for harvesting applications. Generously dimensioned cross-sectional flow areas almost completely prevent clogging. Various guiding vane inserts can be used to cover volume flow rates in the range of 18 m<sup>3</sup>/min to 50 m<sup>3</sup>/min and enable excellent flexibility.

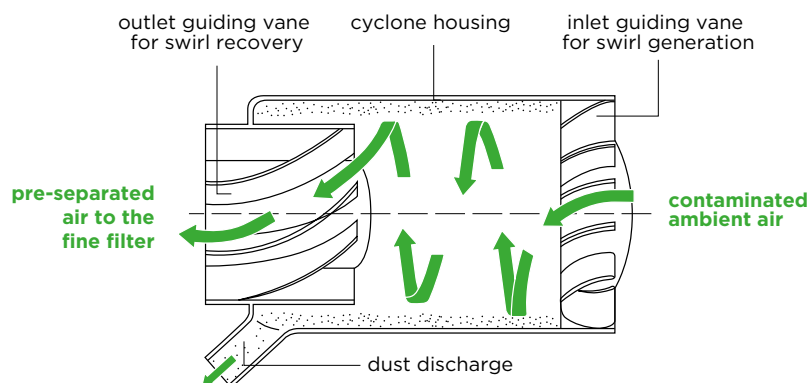

Principle of operation of the DualSpin pre-separator

# NLG series

## At a glance



Technical features	NLG Pico	NLG Piclon	NLG Pico with DualSpin
<b>Type of operation</b>	Single-stage air cleaner	Two-stage air cleaner	Combination air cleaner: single-stage air cleaner with external pre-separator
<b>Field of application</b>	Applications with light dust loads such as commercial vehicles, compressors, marine engines, etc.	Applications with medium dust loads such as construction and agricultural machines	Applications with high dust loads such as construction and agricultural machines which require a longer service life
<b>Air flow requirements</b>	10-45 m <sup>3</sup> /min	10-40 m <sup>3</sup> /min	18-50 m <sup>3</sup> /min
<b>Pre-separator</b>	-	Tangential	Cyclone
<b>Pre-separation efficiency</b>			
■ With dust valve	-	75%	80%
■ With scavenging (5%)	-	> 80%	> 84%
<b>Final separation efficiency</b>	> 99,97%	> 99,97%	> 99,97%
<b>Dust discharge</b>	-	Dust discharge valve (option: scavenging)	Dust discharge valve (option: scavenging)
<b>Installation</b>	Vertical and horizontal installation possible	Vertical and horizontal installation possible <sup>1)</sup>	Vertical and horizontal installation possible <sup>1)</sup>
<b>Servicing concept</b>	Front servicing with standard fasteners	Front servicing with standard fasteners	Front servicing with standard fasteners
<b>Additional protection against ingress of water</b>	Option	Option	Option

1) Depends on the position of the dust discharge valve (valve always directed downwards).

# NLG Pico version

## Part numbers and specifications

### PART NUMBERS

Model	Nominal flow rate [m <sup>3</sup> /min]	Position	Part number		Replacement filter element		Weight [kg]
			without secondary element	with secondary element	Main element	Secondary element	
NLG 15-12	10-18	1	44 513 85 901	44 513 85 950	C 23 513	CF 1240	3.3
		2	44 513 85 902	44 513 85 951			
		3	44 513 85 900	44 513 85 952			
NLG 15-15	10-18	1	44 632 85 905	44 632 85 951	C 23 632/1	CF 1250	3.6
		2	44 632 85 906	44 632 85 952			
		3	44 632 85 900	44 632 85 950			
NLG 15-18	10-18	1	44 750 85 903	44 750 85 951	C 23 750	CF 1260	4.3
		2	44 750 85 904	44 750 85 950			
		3	44 750 85 901	44 750 85 952			
NLG 21-18	12-24	1	44 742 85 905	44 742 85 950	C 25 740	CF 1420	4.3
		2	44 742 85 906	44 742 85 952			
		3	44 742 85 904	44 742 85 953			
NLG 21-21	12-24	1	44 860 85 908	44 860 85 952	C 25 860/5	CF 1430	4.6
		2	44 860 85 909	44 860 85 953			
		3	44 860 85 900	44 860 85 951			
NLG 21-24	12-24	1	44 860 85 911	44 860 85 954	C 25 990	CF 1440	5.1
		2	44 860 85 912	44 860 85 950			
		3	44 860 85 904	44 860 85 955			
NLG 28-24	18-30	1	44 920 85 926	44 920 85 950	C 27 1020	CF 1631	5.2
		2	44 920 85 927	44 920 85 955			
		3	44 920 85 916	44 920 85 956			
NLG 28-28	18-30	1	44 920 85 915	44 920 85 954	C 27 1170	CF 1640	5.6
		2	44 920 85 914	44 920 85 957			
		3	44 920 85 904	44 920 85 952			
NLG 28-32	18-30	1	44 920 85 928	44 920 85 958	C 27 1320/2	CF 1650	6.3
		2	44 920 85 924	44 920 85 951			
		3	44 920 85 918	44 920 85 959			
NLG 37-32	25-45	1	44 930 85 912	44 930 85 950	C 30 1330	CF 1820	6.4
		2	44 930 85 913	44 930 85 956			
		3	44 930 85 902	44 930 85 957			
NLG 37-37	25-45	1	44 930 85 908	44 930 85 958	C 30 1530	CF 1830	7.4
		2	44 930 85 909	44 930 85 959			
		3	44 930 85 900	44 930 85 951			
NLG 37-42	25-45	1	44 930 85 914	44 930 85 955	C 30 1730	CF 1840	7.9
		2	44 930 85 915	44 930 85 952			
		3	44 930 85 901	44 930 85 954			

### NLG PICO VERSION with connection dimension d<sub>2</sub> = 250 mm

Model	Nominal flow rate [m <sup>3</sup> /min]	Figure	Part number		Replacement filter element		Weight [kg]
			without secondary element	with secondary element	Main element	Secondary element	
NLG 37-37	25-45	1	-	44 930 85 953 <sup>1)</sup>	C 30 1530	CF 1830	8.3
NLG 37-42	25-45	1	-	44 930 85 960 <sup>1)</sup>	C 30 1730	CF 1840	8.7
		2		44 930 85 974 <sup>2)</sup>			
		1		44 930 85 975 <sup>2)</sup>			

1) Pleat height 48 mm

2) Pleat height 60 mm



# NLG Pico version Specifications

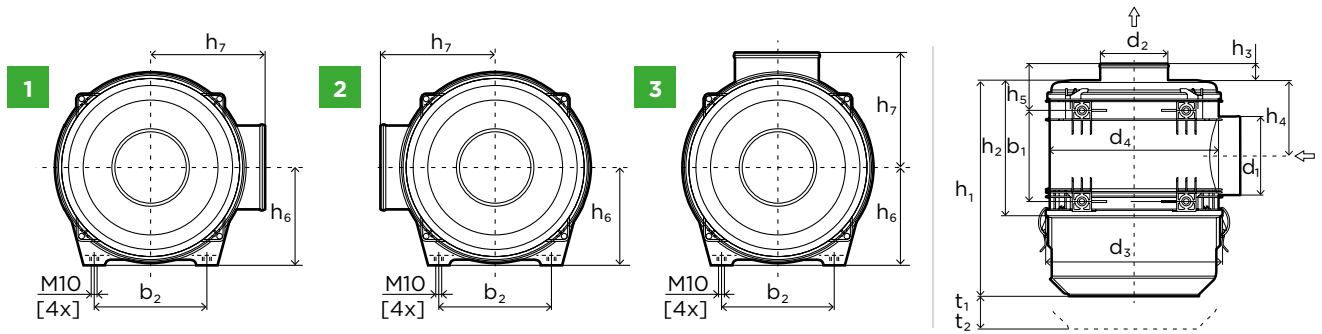

## DIMENSIONS

Model	Dimensions in mm (dimensions in inches)														
	b <sub>1</sub>	b <sub>2</sub>	d <sub>1</sub>	d <sub>2</sub>	d <sub>3</sub>	d <sub>4</sub>	h <sub>1</sub>	h <sub>2</sub>	h <sub>3</sub>	h <sub>4</sub>	h <sub>5</sub>	h <sub>6</sub>	h <sub>7</sub>	t <sub>1</sub> <sup>1)</sup>	t <sub>2</sub> <sup>2)</sup>
NLG 15-12							305 (12.01)								273 (10.75)
NLG 15-15	140 (5.51)	200 (7.87)	130 (5.12)	110 (4.33)	299 (11.77)	285 (11.22)	360 (14.17)	228 (8.98)	33 (1.30)	120 (4.72)	91 (3.59)	153 (6.02)	182 (7.17)	230 (9.06)	328 (12.91)
NLG 15-18							415 (16.34)								383 (15.08)
NLG 21-18							365 (14.37)								332 (13.07)
NLG 21-21	175 (6.89)	200 (7.87)	150 (5.91)	130 (5.12)	339 (13.35)	323 (12.72)	415 (16.34)	260 (10.24)	33 (1.30)	145.5 (5.73)	91 (3.59)	173 (6.81)	203 (7.99)	260 (10.24)	382 (15.04)
NLG 21-24							465 (18.31)								432 (17.01)
NLG 28-24							427 (16.81)								395 (15.55)
NLG 28-28	210 (8.27)	200 (7.87)	180 (7.09)	150 (5.91)	365 (14.37)	349 (13.74)	480 (18.90)	295 (11.61)	33 (1.30)	163 (6.42)	91 (3.59)	185 (7.28)	215 (8.46)	296 (11.65)	448 (17.64)
NLG 28-32							533 (20.98)								501 (19.72)
NLG 37-32							498 (19.61)								465 (18.31)
NLG 37-37	245 (9.65)	240 (9.45)	210 (8.27)	180 (7.09)	407 (16.02)	393 (15.47)	563 (22.17)	363 (14.29)	33 (1.30)	188 (7.40)	91 (3.59)	207 (8.15)	237 (9.33)	364 (14.33)	530 (20.87)
NLG 37-42							628 (24.72)								595 (23.43)

## SPECIFICATIONS

Model	Housing material	Dust discharge connection diameter	Tightening torque		Operating temperature		Discharge valve orientation (downwards)
			Hose clamp (clean side)	Threaded insert	Continuous	Short-term	
NLG Pico	PP-GF30	-	max. 5 Nm	22 Nm	-40 °C to +80 °C	+100 °C	- <sup>3)</sup>

1) Removal height without secondary element

2) Removal height with secondary element

3) When using with diaphragm valve, ensure positioning at the lowest point of the housing.

# NLG Pico version

## Flow characteristics

### NLG 15-12

Flow rate

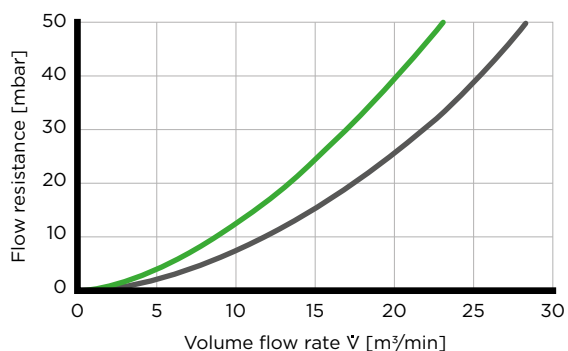

### NLG 15-12

Dust capacity

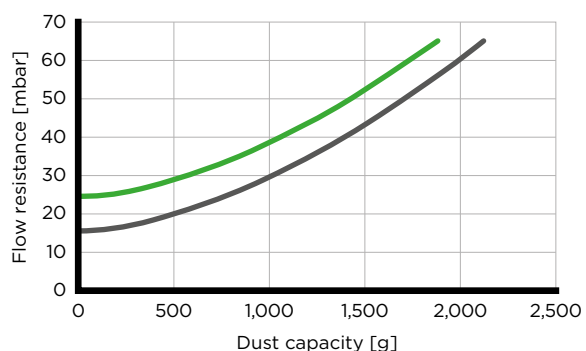

### NLG 15-15

Flow rate

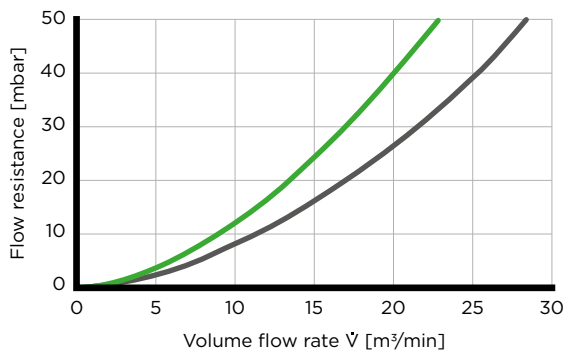

### NLG 15-15

Dust capacity

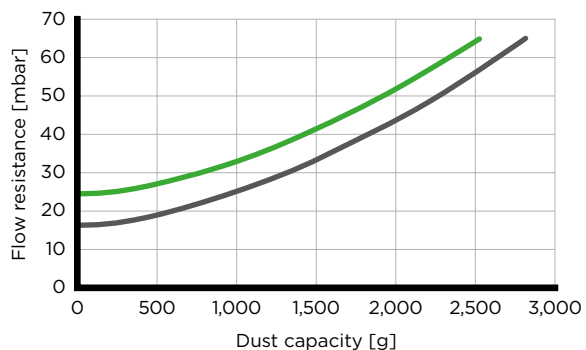

### NLG 15-18

Flow rate

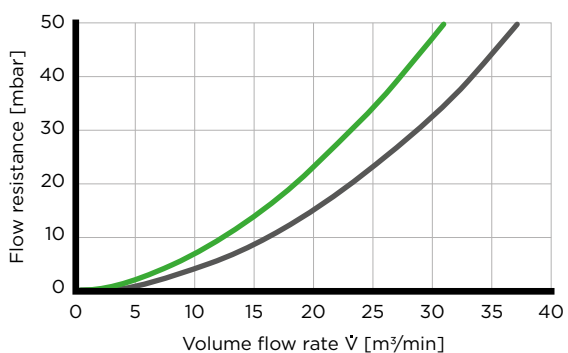

### NLG 15-18

Dust capacity

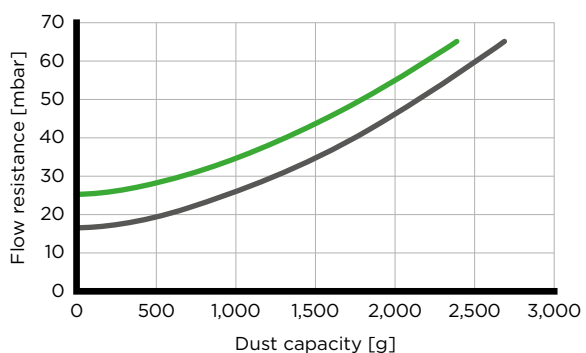

■ With secondary element ■ Without secondary element

Data with scavenging on request.

Flow characteristics measured according to ISO 5011 with ISO coarse at nominal flow rates according to the specifications.

# NLG Pico version

## Flow characteristics

### NLG 21-18

Flow rate

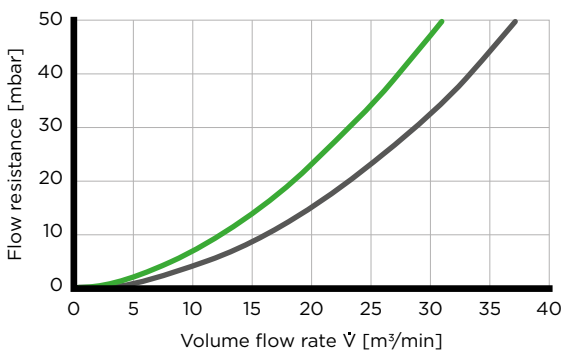

### NLG 21-18

Dust capacity

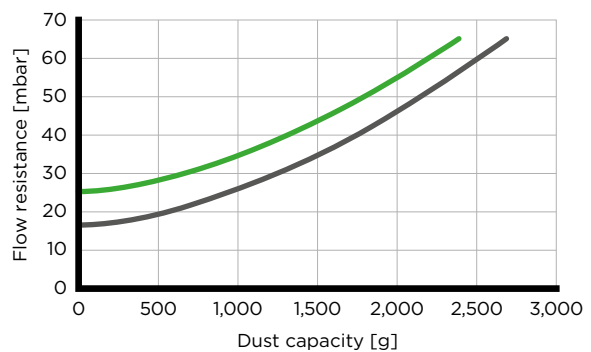

### NLG 21-21

Flow rate

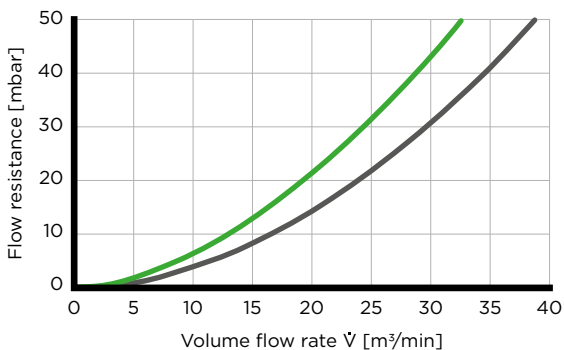

### NLG 21-21

Dust capacity

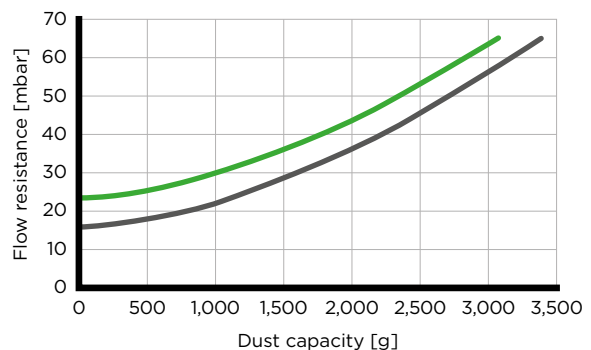

### NLG 21-24

Flow rate

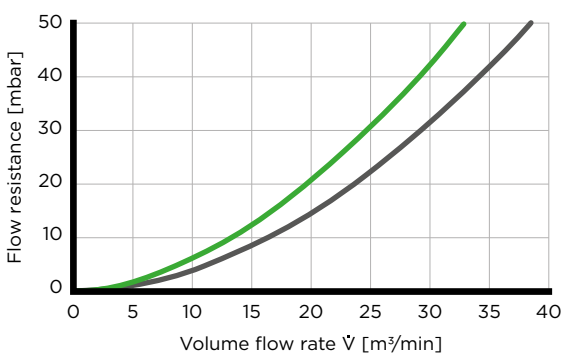

### NLG 21-24

Dust capacity

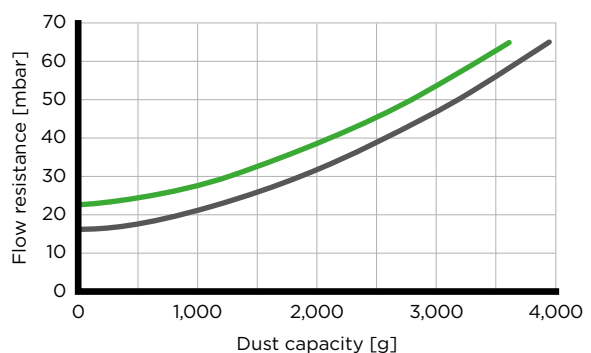

■ With secondary element ■ Without secondary element

Data with scavenging on request.

Flow characteristics measured according to ISO 5011 with ISO coarse at nominal flow rates according to the specifications.

# NLG Pico version

## Flow characteristics

### NLG 28-24

Flow rate

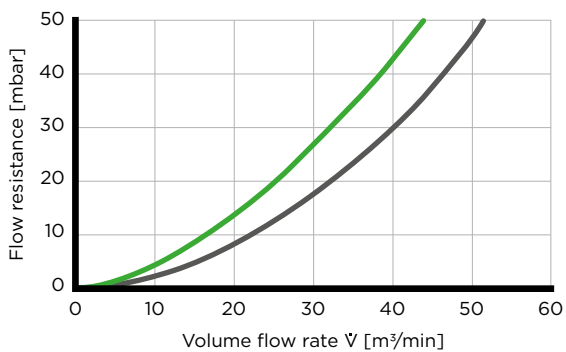

### NLG 28-24

Dust capacity

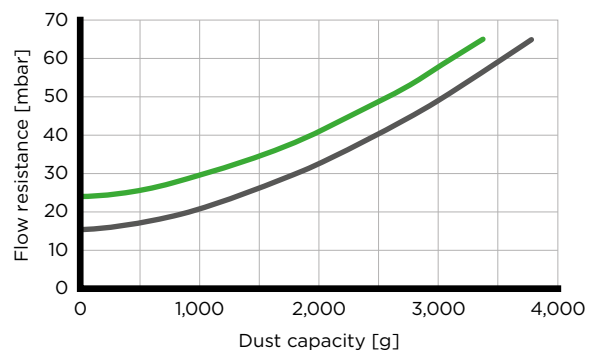

### NLG 28-28

Flow rate

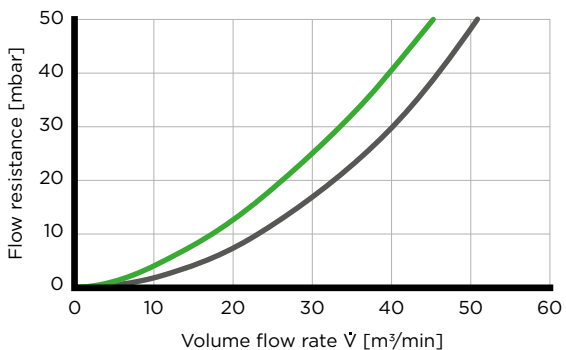

### NLG 28-28

Dust capacity

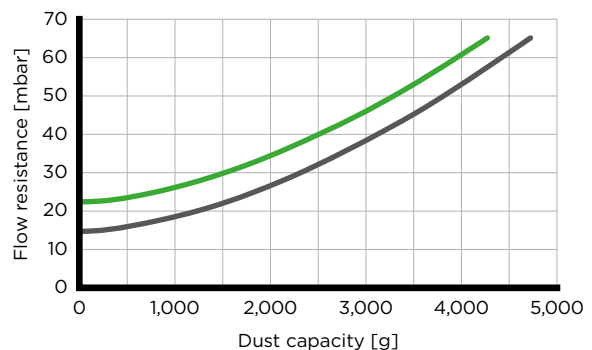

### NLG 28-32

Flow rate

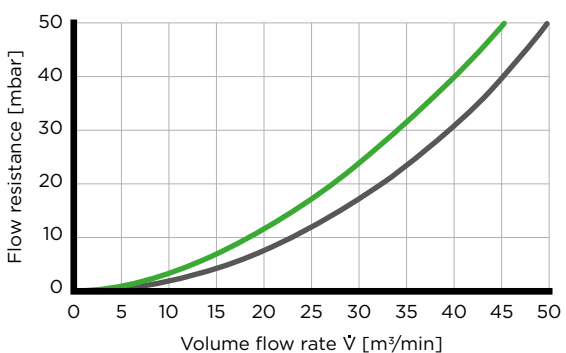

### NLG 28-32

Dust capacity

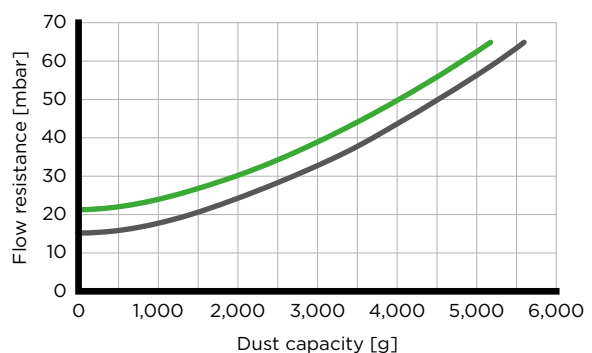

■ With secondary element ■ Without secondary element

Data with scavenging on request.

Flow characteristics measured according to ISO 5011 with ISO coarse at nominal flow rates according to the specifications.

# NLG Pico version

## Flow characteristics

### NLG 37-32

Flow rate

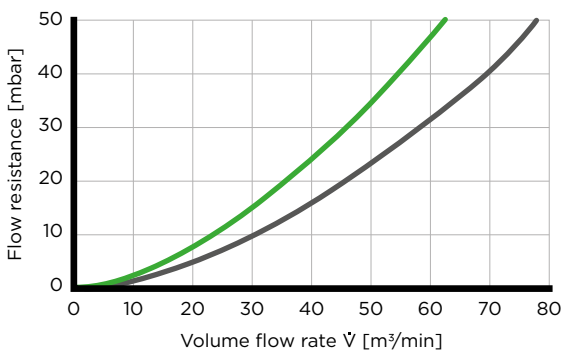

### NLG 37-32

Dust capacity

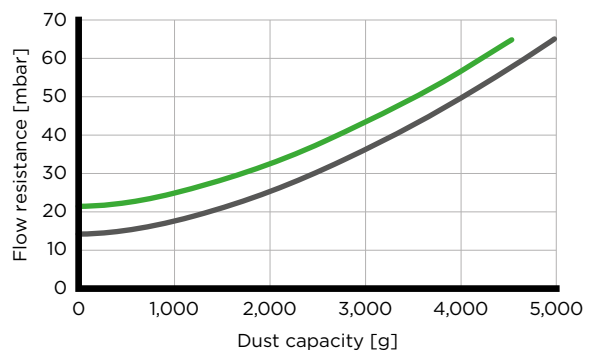

### NLG 37-37

Flow rate

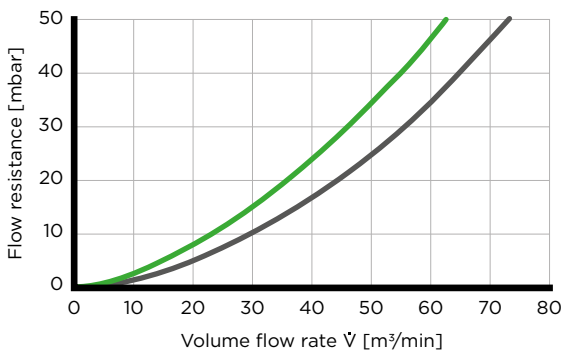

### NLG 37-37

Dust capacity

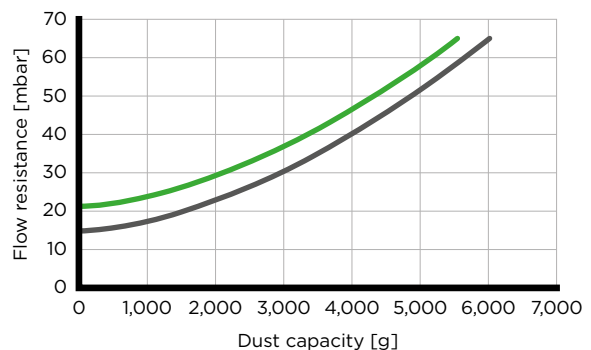

### NLG 37-42

Flow rate

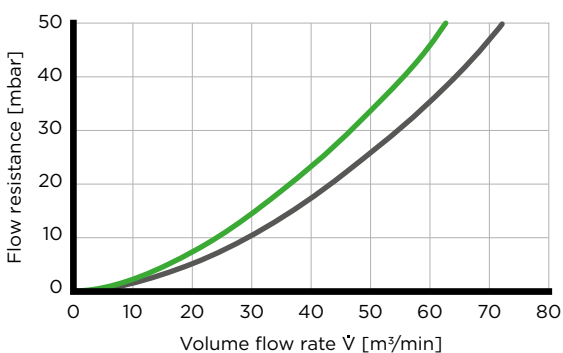

### NLG 37-42

Dust capacity

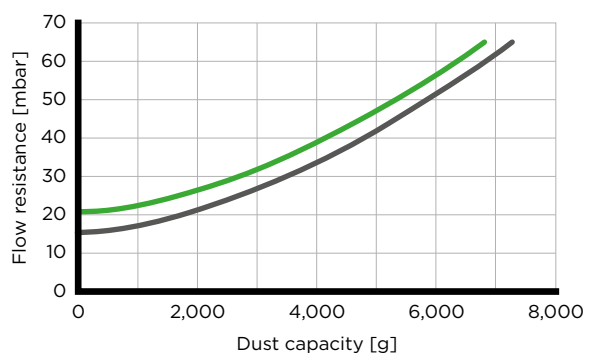

■ With secondary element ■ Without secondary element

Data with scavenging on request.

Flow characteristics measured according to ISO 5011 with ISO coarse at nominal flow rates according to the specifications.

# NLG Piclon version

## Part numbers and specifications

### PART NUMBERS

Model	Nominal flow rate [m <sup>3</sup> /min]	Position	Part number		Replacement filter element		Weight [kg]
			without secondary element	with secondary element	Main element	Secondary element	
NLG 15-15	10-15	1	44 526 92 900	44 526 92 951	C 22 526/1	CF 1250	3.6
		2	44 526 92 901	44 526 92 952			
		3	44 526 92 902	44 526 92 950			
NLG 15-18	10-15	1	44 625 92 901	44 625 92 951	C 22 625	CF 1260	4.3
		2	44 625 92 902	44 625 92 952			
		3	44 625 92 900	44 625 92 950			
NLG 21-21	15-21	1	44 722 92 905	44 722 92 954	C 24 745/1	CF 1430	4.6
		2	44 722 92 906	44 722 92 953			
		3	44 722 92 904	44 722 92 950			
NLG 21-24	15-21	1	44 722 92 907	44 722 92 956	C 24 820	CF 1440	5.1
		2	44 722 92 908	44 722 92 957			
		3	44 722 92 903	44 722 92 951			
NLG 28-28	20-28	1	44 920 92 906	44 920 92 956	C 26 980	CF 1640	5.6
		2	44 920 92 907	44 920 92 954			
		3	44 920 92 902	44 920 92 950			
NLG 28-32	20-28	1	44 920 92 908	44 920 92 957	C 26 1100	CF 1650	6.3
		2	44 920 92 909	44 920 92 958			
		3	44 920 92 903	44 920 92 951			
NLG 37-37	25-40	1	44 930 92 902	44 930 92 950	C 28 1275	CF 1830	7.4
		2	44 930 92 903	44 930 92 953			
		3	44 930 92 900	44 930 92 951			
NLG 37-42	25-40	1	44 930 92 904	44 930 92 954	C 28 1440	CF 1840	7.9
		2	44 930 92 905	44 930 92 955			
		3	44 930 92 901	44 930 92 952			

### SPECIFICATIONS

Model	Housing material	Dust discharge connection diameter	Tightening torque		Operating temperature		Discharge valve orientation (downwards)
			Hose clamp (clean side)	Threaded insert	Continuous	Short-term	
NLG Piclon	PP-GF30	40 mm (1.57 inches)	max. 5 Nm	22 Nm	-40 °C to +80 °C	+100 °C	±15° <sup>1)</sup>

1) Applies to dust discharge valve; for diaphragm valve, ensure positioning at the lowest point of the housing.

# NLG Piclon version Specifications

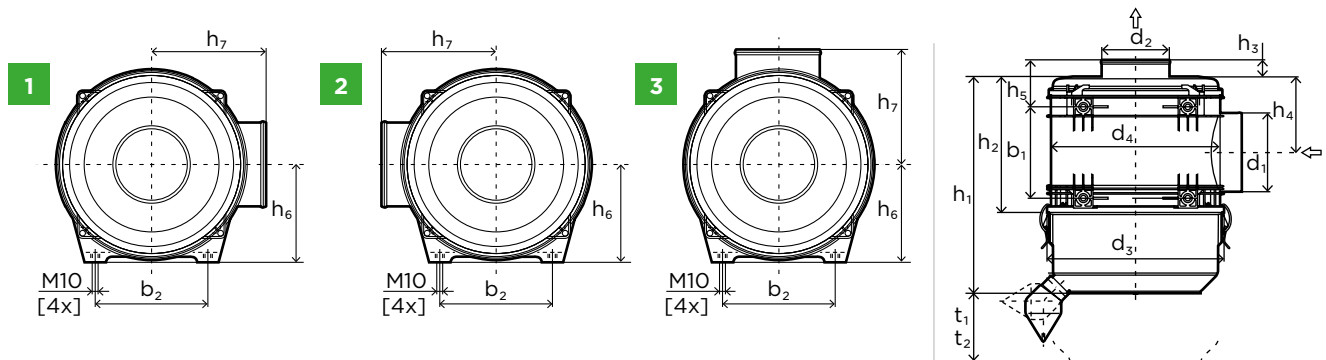

## DIMENSIONS

Model	Dimensions in mm (dimensions in inches)														
	b <sub>1</sub>	b <sub>2</sub>	d <sub>1</sub>	d <sub>2</sub>	d <sub>3</sub>	d <sub>4</sub>	h <sub>1</sub>	h <sub>2</sub>	h <sub>3</sub>	h <sub>4</sub>	h <sub>5</sub>	h <sub>6</sub>	h <sub>7</sub>	t <sub>1</sub> <sup>1)</sup>	t <sub>2</sub> <sup>2)</sup>
<b>NLG 15-15</b>	140 (5.51)	200 (7.87)	130 (5.12)	110 (4.33)	299 (11.77)	285 (11.22)	360 (14.17)	228 (8.98)	33 (1.30)	120 (4.72)	91 (3.59)	153 (6.02)	182 (7.17)	230 (9.06)	328 (12.91)
<b>NLG 15-18</b>							415 (16.34)								383 (15.08)
<b>NLG 21-21</b>	175 (6.89)	200 (7.87)	150 (5.91)	130 (5.12)	339 (13.35)	323 (12.72)	415 (16.34)	260 (10.24)	33 (1.30)	145.5 (5.73)	91 (3.59)	173 (6.81)	203 (7.99)	260 (10.24)	382 (15.04)
<b>NLG 21-24</b>							465 (18.31)								432 (17.01)
<b>NLG 28-28</b>	210 (8.27)	200 (7.87)	180 (7.09)	150 (5.91)	365 (14.37)	349 (13.74)	480 (18.90)	295 (11.61)	33 (1.30)	163 (6.42)	91 (3.59)	185 (7.28)	215 (8.46)	296 (11.65)	448 (17.64)
<b>NLG 28-32</b>							533 (20.98)								501 (19.72)
<b>NLG 37-37</b>	245 (9.65)	240 (9.45)	210 (8.27)	180 (7.09)	407 (16.02)	393 (15.47)	563 (22.17)	363 (14.29)	33 (1.30)	188 (7.40)	91 (3.59)	207 (8.15)	237 (9.33)	364 (14.33)	530 (20.87)
<b>NLG 37-42</b>							628 (24.72)								595 (23.43)

1) Removal height without secondary element

2) Removal height with secondary element

# NLG Piclon version

## Flow characteristics

### NLG 15-15

Flow rate

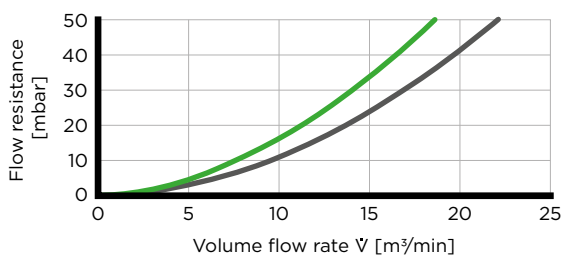

### NLG 15-15

Dust capacity

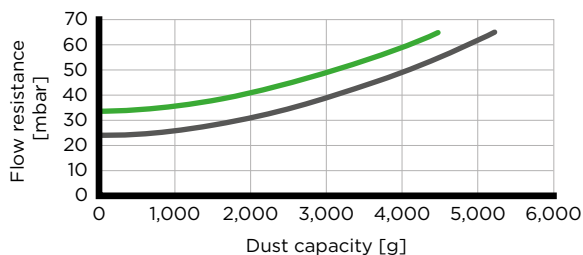

### NLG 15-18

Flow rate

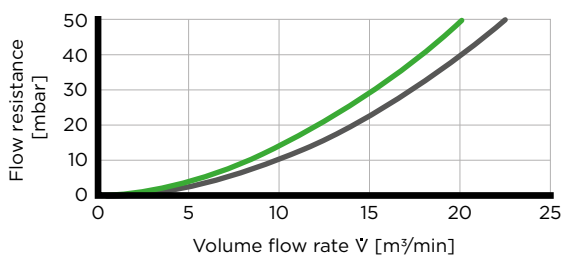

### NLG 15-18

Dust capacity

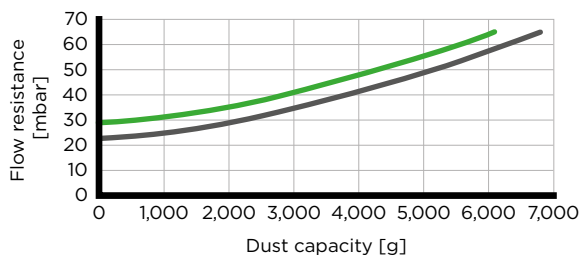

### NLG 21-21

Flow rate

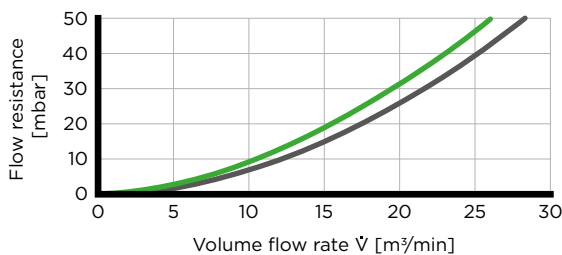

### NLG 21-21

Dust capacity

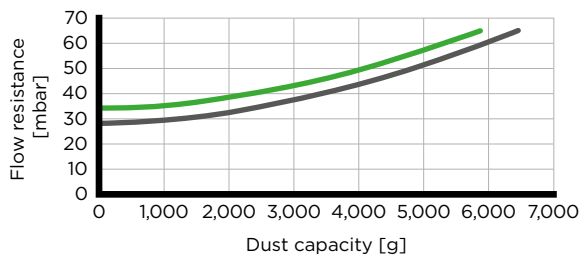

### NLG 21-24

Flow rate

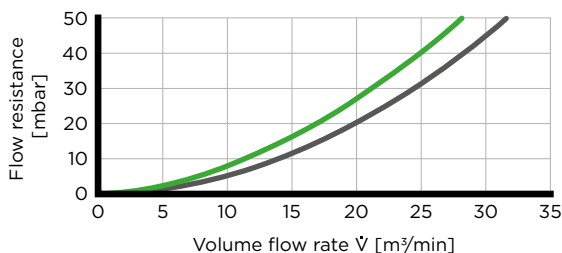

### NLG 21-24

Dust capacity

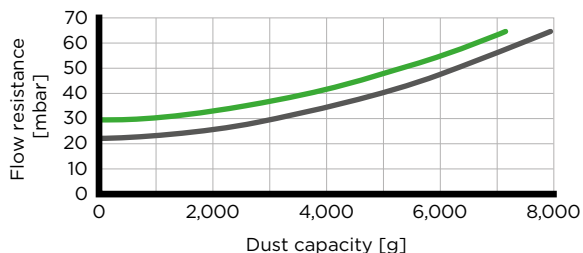

■ With secondary element ■ Without secondary element

Data with scavenging on request.

Flow characteristics measured according to ISO 5011 with ISO coarse at nominal flow rates according to the specifications.



# NLG Piclon version

## Flow characteristics

### NLG 28-28

Flow rate

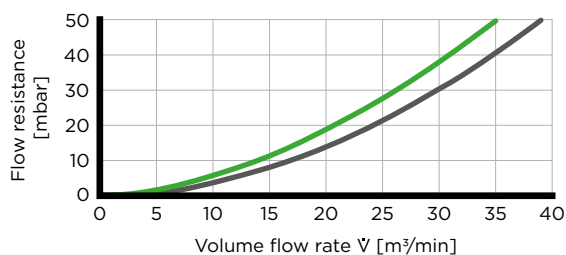

### NLG 28-28

Dust capacity

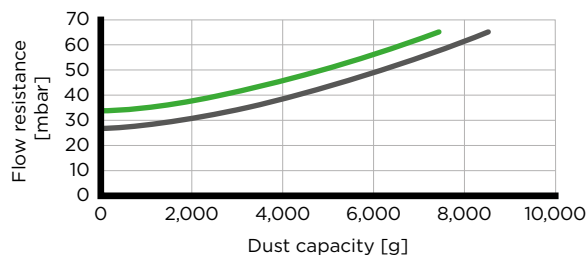

### NLG 28-32

Flow rate

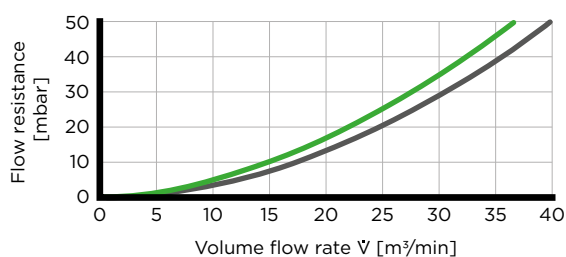

### NLG 28-32

Dust capacity

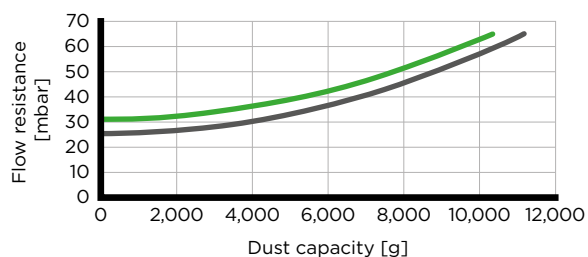

### NLG 37-37

Flow rate

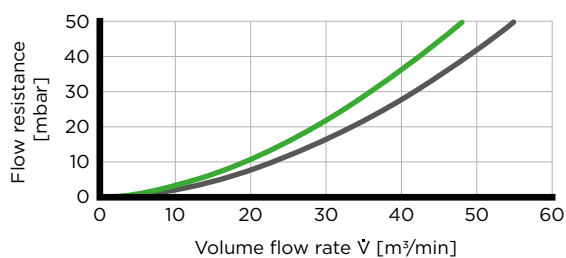

### NLG 37-37

Dust capacity

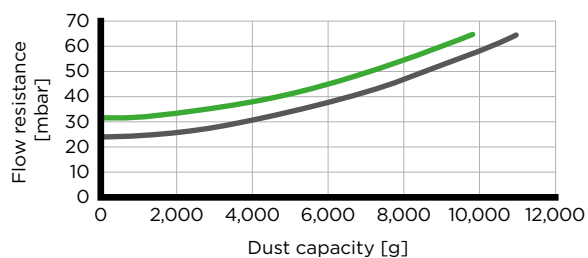

### NLG 37-42

Flow rate

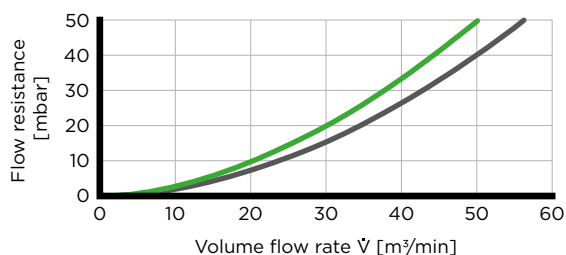

### NLG 37-42

Dust capacity

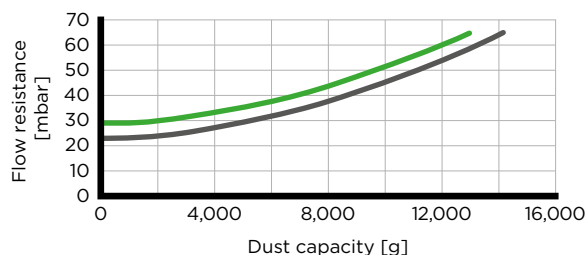

■ With secondary element ■ Without secondary element

Data with scavenging on request.

Flow characteristics measured according to ISO 5011 with ISO coarse at nominal flow rates according to the specifications.

# DualSpin combination air cleaner Part numbers and specifications

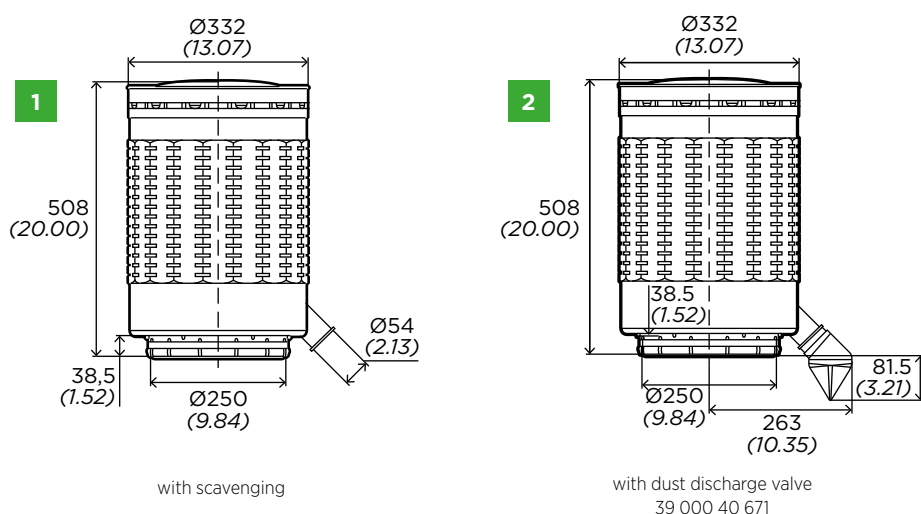

## NLG PICO VERSION FOR USE WITH DUALSPIN

Model	Part number	Connection diameter	Replacement filter element	
	Secondary element		Main element	Secondary element
<b>NLG 37-37</b>	44 930 85 953 <sup>1)</sup>	250 mm (9.84 Inches)	C 30 1530	CF 1830
<b>NLG 37-42</b>	44 930 85 960 <sup>1)</sup> 44 930 85 974 <sup>2)</sup> 44 930 85 975 <sup>2)</sup>	250 mm (9.84 Inches)	C 30 1730 C 33 2200 C 33 2200	CF 1840

1) Pleat height 48 mm

2) Pleat height 60 mm

# DualSpin combination air cleaner Part numbers and specifications

## DUALSPIN PRE-SEPARATOR

Model	Nominal flow rate [m <sup>3</sup> /min]	Bracket suitable for pre-separator (option)	Part number		Weight [kg]
			Without dust discharge valve Figure 1	With dust discharge valve Figure 2	
DualSpin 25	18-25	39 700 40 999	48 025 75 900	48 025 75 910	2.4
DualSpin 37	25-50		48 037 75 910	48 037 75 920	

## SPECIFICATIONS

Model	Housing material	Dust discharge connection diameter	Tightening torque		Operating temperature		Discharge valve orientation (downwards)
			Hose clamp (clean side)	Threaded insert	Continuous	Short-term	
NLG DualSpin combination air cleaner	PP-GF30	54 mm (2.26 inches)	max. 5 Nm	22 Nm	-40 °C to +80 °C	+100 °C	±15°

# DualSpin combination air cleaner Flow characteristics

## NLG 37-37 with DualSpin 25 and valve

Flow rate

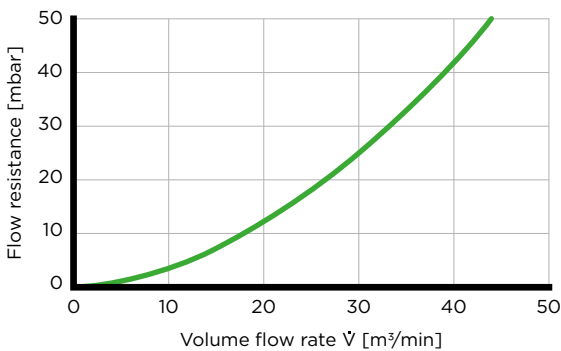

## NLG 37-37 with DualSpin 25 and valve

Dust capacity

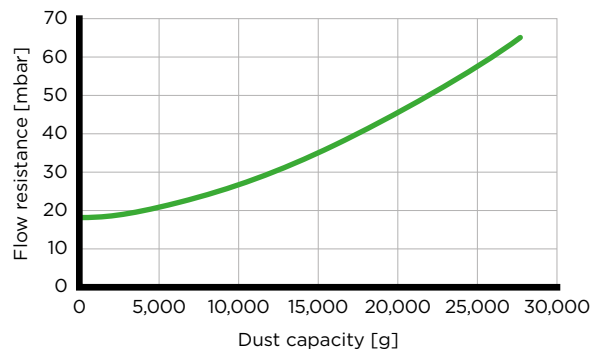

## NLG 37-42 with DualSpin 25 and valve

Flow rate

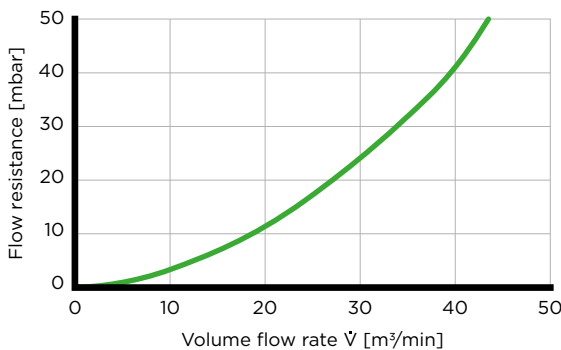

## NLG 37-42 with DualSpin 25 and valve

Dust capacity

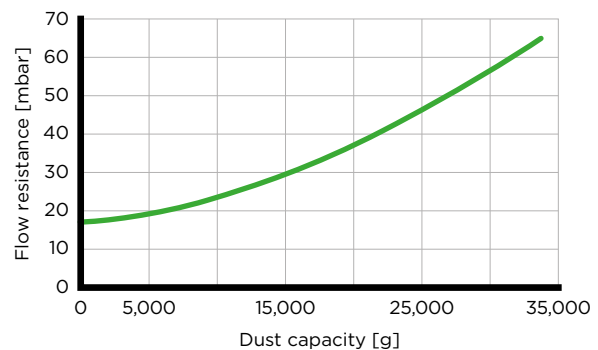

### ■ With secondary element

Flow characteristics measured according to ISO 5011 with ISO coarse at nominal flow rates according to the specifications.

# DualSpin combination air cleaner Flow characteristics

## NLG 37-37 with DualSpin 37 and valve

Flow rate

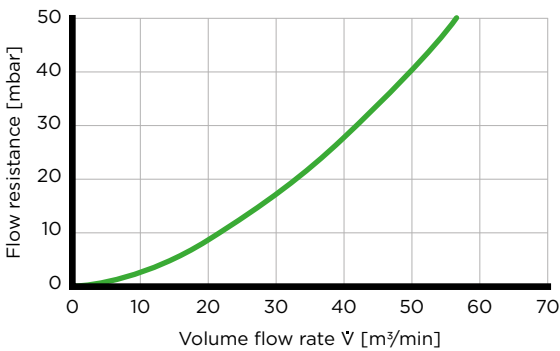

## NLG 37-37 with DualSpin 37 and valve

Dust capacity

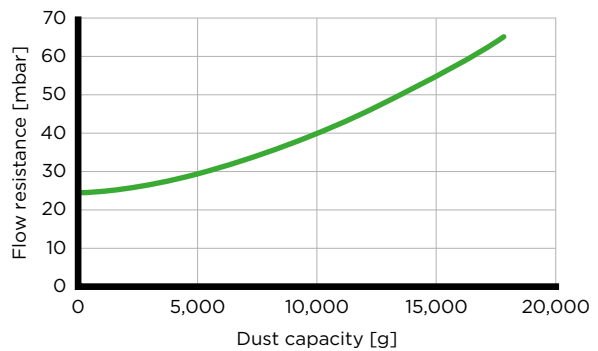

## NLG 37-42 with DualSpin 37 and valve

Flow rate

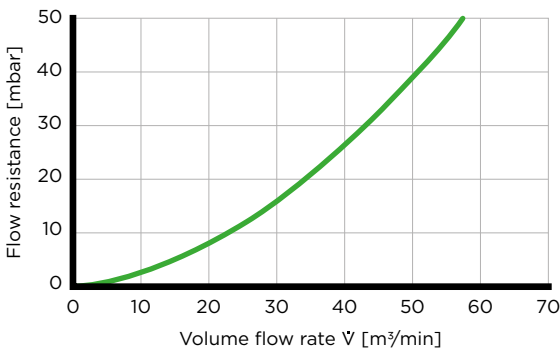

## NLG 37-42 with DualSpin 37 and valve

Dust capacity

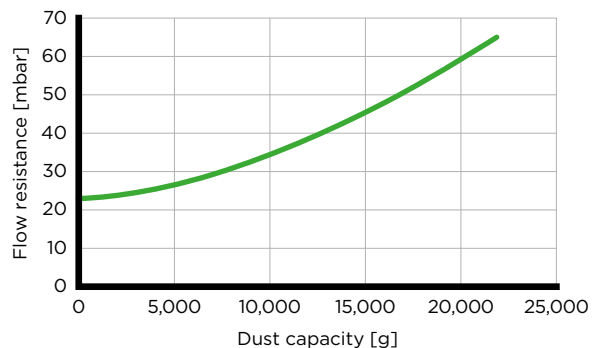

## NLG 37-42 (60 mm) with DualSpin 37 and valve

Flow rate

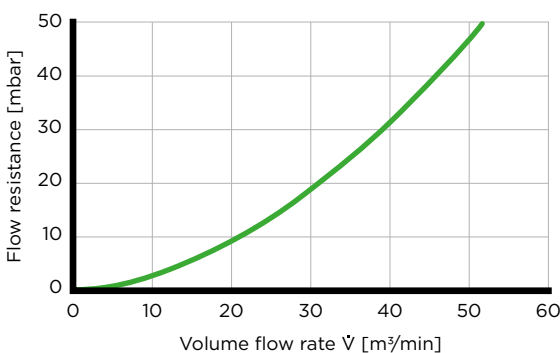

## NLG 37-42 (60 mm) with DualSpin 37 and valve

Dust capacity

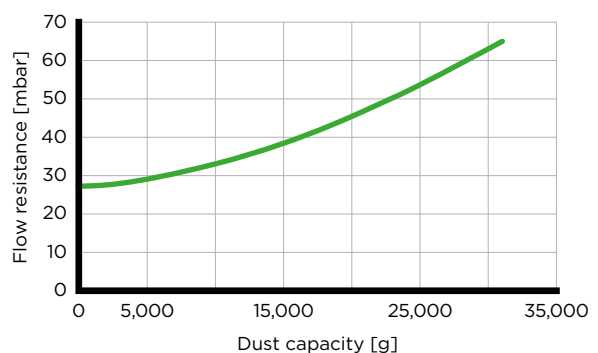

### ■ With secondary element

Flow characteristics measured according to ISO 5011 with ISO coarse at nominal flow rates according to the specifications.

# DualSpin combination air cleaner Flow characteristics

## NLG 37-37 with DualSpin 25 and scavenging (10%)

Flow rate

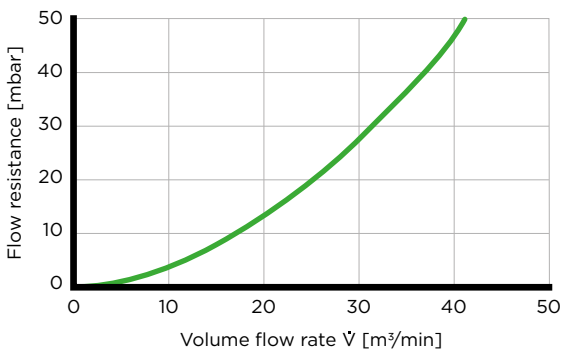

## NLG 37-37 with DualSpin 25 and scavenging (10%)

Dust capacity

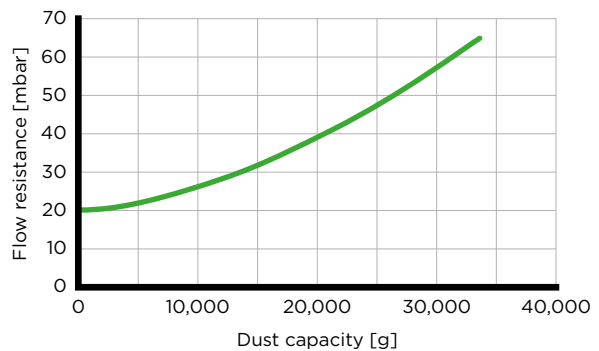

## NLG 37-42 with DualSpin 25 and scavenging (10%)

Flow rate

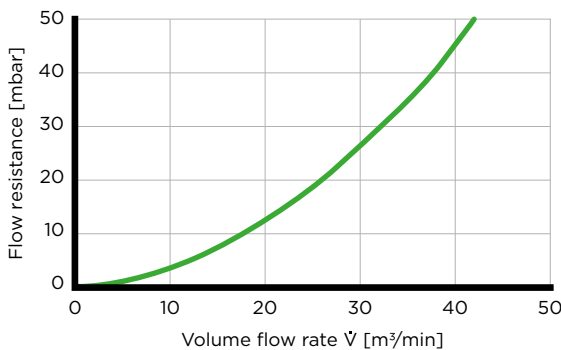

## NLG 37-42 with DualSpin 25 and scavenging (10%)

Dust capacity

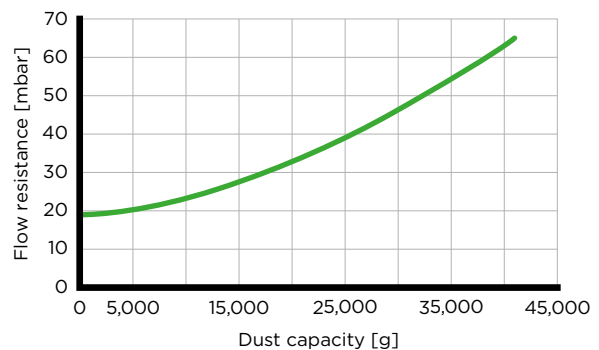

### ■ With secondary element

Flow characteristics measured according to ISO 5011 with ISO coarse at nominal flow rates according to the specifications.

# DualSpin combination air cleaner Flow characteristics

**NLG 37-37 with DualSpin 37 and scavenging (10%)**

Flow rate

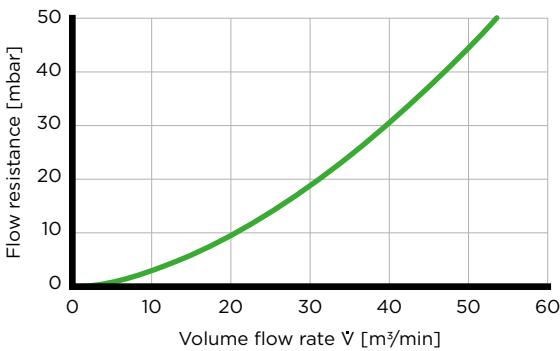

**NLG 37-37 with DualSpin 37 and scavenging (10%)**

Dust capacity

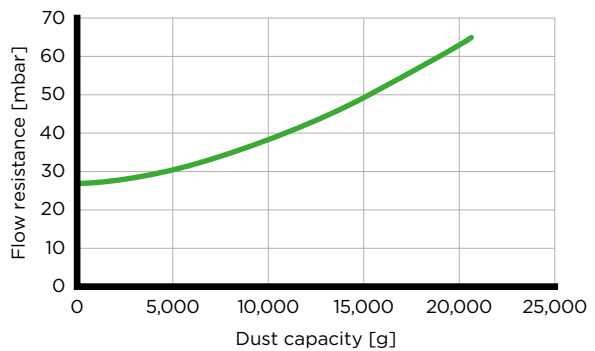

**NLG 37-42 with DualSpin 37 and scavenging (10%)**

Flow rate

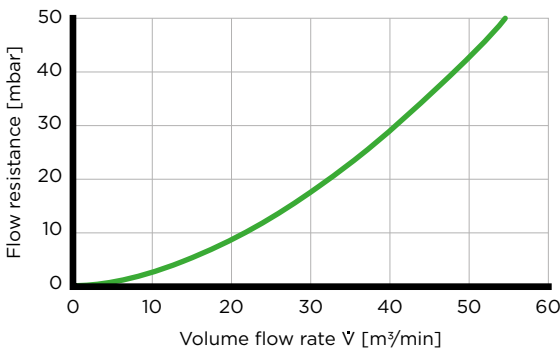

**NLG 37-42 with DualSpin 37 and scavenging (10%)**

Dust capacity

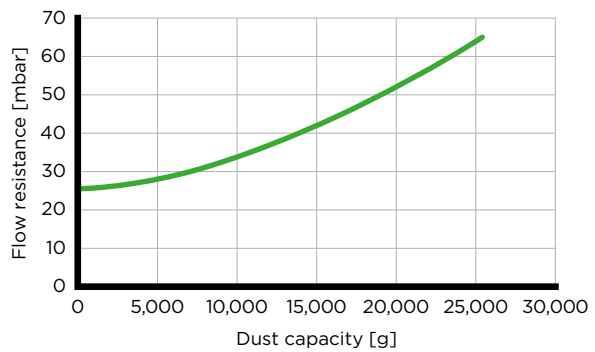

**NLG 37-42 (60 mm) with DualSpin 37 and scavenging (10%)**

Flow rate

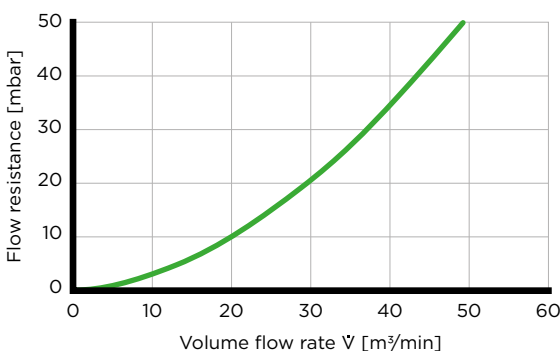

**NLG 37-42 (60 mm) with DualSpin 37 and scavenging (10%)**

Dust capacity

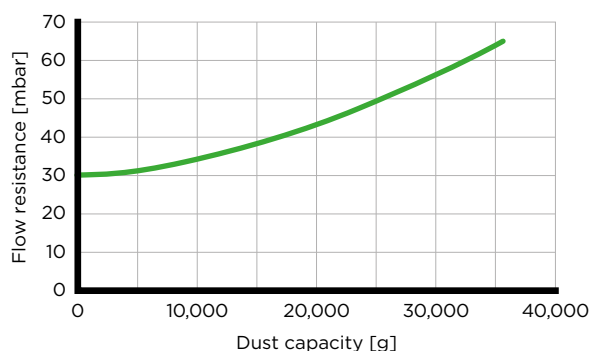

**■ With secondary element**

Flow characteristics measured according to ISO 5011 with ISO coarse at nominal flow rates according to the specifications.

# NLG

## Spare parts

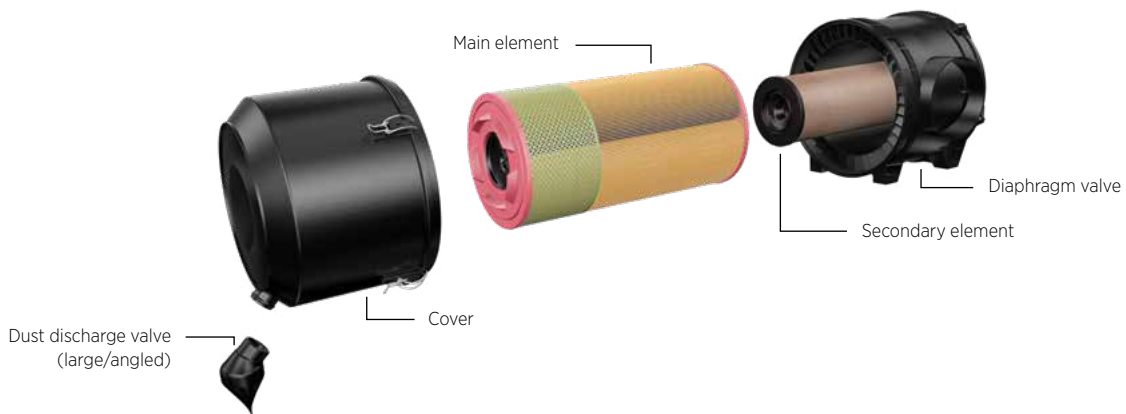

### PART NUMBERS

Model	Part number			Replacement filter element	
	Dust discharge valve (large/angled)	Diaphragm valve	Cover	Main filter element	Secondary element
<b>NLG Pico</b>					
NLG 15-12			44 513 12 999	C 23 513	CF 1240
NLG 15-15			44 632 12 909	C 23 632/1	CF 1250
NLG 15-18			44 750 12 999	C 23 750	CF 1260
NLG 21-18			44 742 12 901	C 25 740	CF 1420
NLG 21-21			44 860 12 905	C 25 860/5	CF 1430
NLG 21-24			44 860 12 906	C 25 990	CF 1440
NLG 28-24		23 040 30 121	44 920 12 913	C 27 1020	CF 1631
NLG 28-28			44 920 12 851	C 27 1170	CF 1640
NLG 28-32			44 920 12 811	C 27 1320/2	CF 1650
NLG 37-32			44 930 12 959	C 30 1330	CF 1820
NLG 37-37			44 930 12 969	C 30 1530	CF 1830
NLG 37-42			44 930 12 929	C 30 1730	CF 1840
<b>NLG Piclon</b>					
NLG 15-15			44 526 12 999	C 22 526/1	CF 1250
NLG 15-18			44 625 12 999	C 22 625	CF 1260
NLG 21-21			44 860 12 908	C 24 745/1	CF 1430
NLG 21-24	39 000 40 661		44 860 12 909	C 24 820	CF 1440
NLG 28-28			44 920 12 903	C 26 980	CF 1640
NLG 28-32			44 920 12 904	C 26 1100	CF 1650
NLG 37-37			44 930 12 979	C 28 1275	CF 1830
NLG 37-42			44 930 12 919	C 28 1440	CF 1840
<b>NLG DualSpin</b>					
NLG DualSpin	39 000 40 671	-	-	-	-



# NLG

## Accessories



### PART NUMBERS

Model	Rain cap <sup>1)</sup> (Page 134)	Straight connection (Page 139)		90 degree elbow (Page 138)	
	Design A <sup>2)</sup> Figure 1	Without connection <sup>3)</sup> Figure 2	With connection <sup>3)</sup> Figure 2	Without connection <sup>3)</sup> Figure 3	With connection <sup>3)</sup> Figure 3
<b>NLG Group 15</b>	39 160 67 910	39 600 27 999	39 600 27 979	39 600 25 999	39 600 25 979
<b>NLG Group 21</b>	39 190 67 910	39 700 27 999	39 700 27 979	39 700 25 999	39 700 25 979
<b>NLG Group 28</b>	39 220 67 910	39 800 27 999	39 800 27 979	39 800 25 999	39 800 25 979
<b>NLG Group 37</b>	39 370 67 910	39 930 27 999	39 930 27 979	39 930 25 999	39 930 25 979

1) Cr(VI)-free

2) Design B possible as alternative (see page 135).

3) For service indicator/switch



#### NOTE

The complete range of accessories for our air cleaners can be found starting on page 132.



# Europiclön

## The flexible all-rounder

**The Europiclön from MANN+HUMMEL is a variable modular system with an extensive range of accessories. These characteristics have made the successful Europiclön a proven intake air cleaner for all machines and devices which are used in environments with medium to high dust loads.**

### ADVANTAGES

- Long service life through integrated pre-separation
- Corrosion-free housing made from plastic
- Cr(VI)-free components
- Environmentally-friendly and economical disposal through filter elements which are metal-free and fully incinerable
- Flexible adaptation through separate bracket
- Standard wire clamp fasteners for easy change of filter elements without need for tools

### EUROPICLÖN 50

- Rotatable clean air outlet with integrated connection for service indicator or switch
- Clean air outlet either as straight version or with a 90 degree elbow

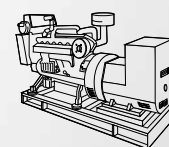
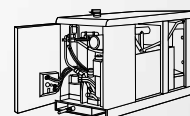
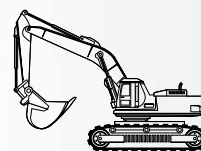

# Europiclone 50 Specifications

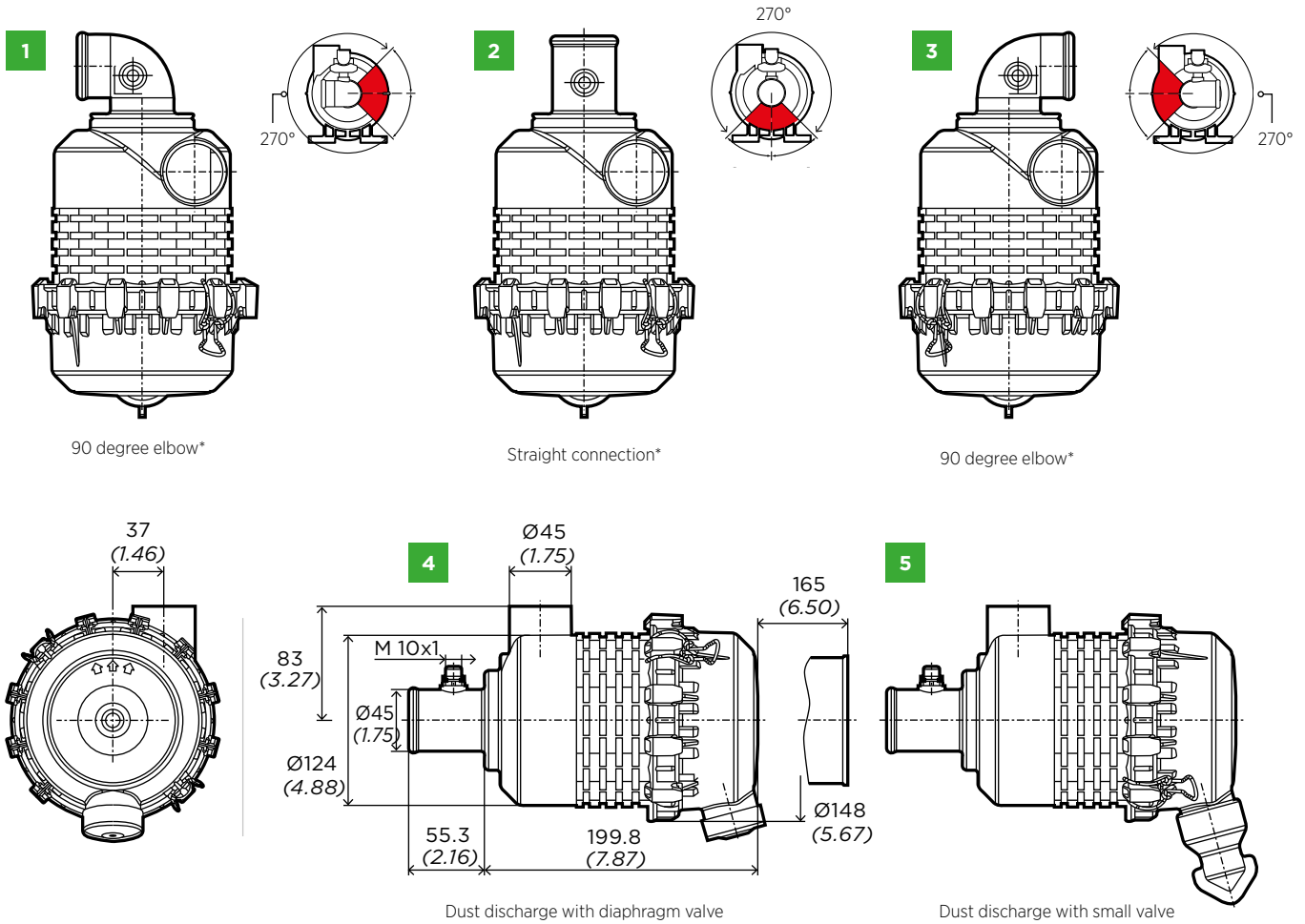

## PART NUMBERS

Model	Nominal flow rate [m <sup>3</sup> /min]	Version with clean air outlet	Version with dust discharge	Part number		Replacement filter element		Weight [kg]
				without secondary element	with secondary element	Main element	Secondary element	
Europiclone 50	0.8-2	1	5	45 058 92 910	45 058 92 911	C 10 050	CF 50	0.7
		1	4	45 058 92 920	45 058 92 921			
		2	5	45 050 92 910	45 050 92 911			
		2	4	45 050 92 920	45 050 92 921			
		3	5	45 059 92 910	45 059 92 911			
		3	4	45 059 92 920	45 059 92 921			

\* Avoid the red area during installation.

# Europiclon 50

## Flow characteristics

### Europiclon 50 with straight connection

Flow rate

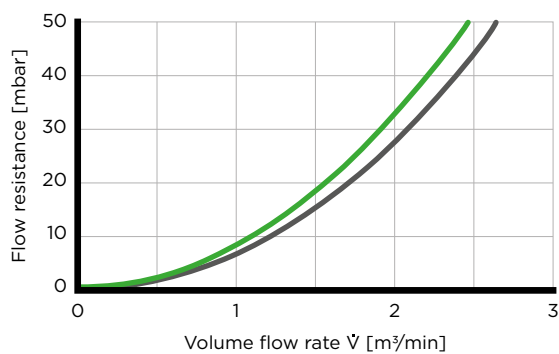

### Europiclon 50 with straight connection

Dust capacity

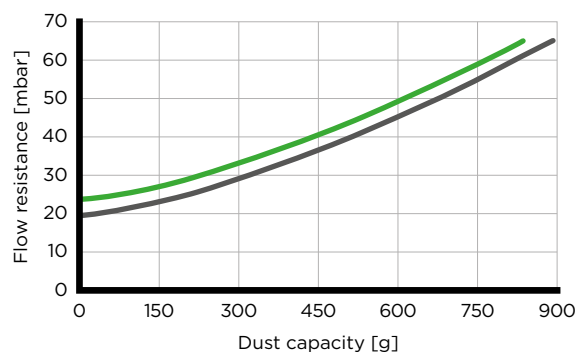

### Europiclon 50 with 90 degree elbow

Flow rate

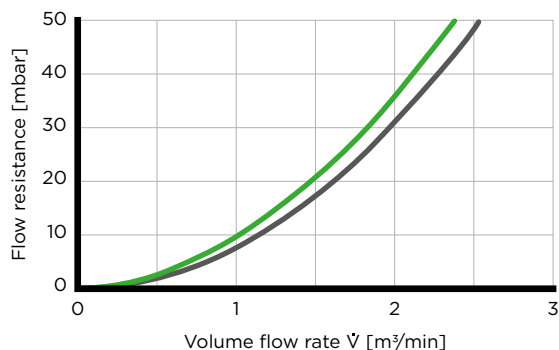

### Europiclon 50 with 90 degree elbow

Dust capacity

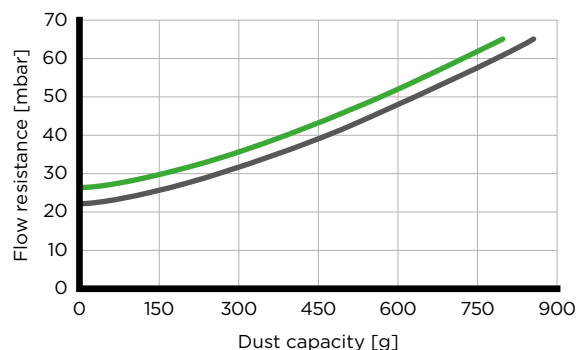

■ With secondary element ■ Without secondary element

Data with scavenging on request.

Flow characteristics measured according to ISO 5011 with ISO coarse at nominal flow rates according to the specifications.

# Europiclon 100-600

## Part numbers und specifications

### PART NUMBERS

Model	Nominal flow rate [m <sup>3</sup> /min]	Figure	Part number		Replacement filter element		Weight [kg]
			without secondary element	with secondary element	Main element	Secondary element	
Europiclon 100	1 - 3	1	45 100 92 910	45 100 92 911	C 11 100	CF 100	0.9
		2	45 100 92 940	45 100 92 941			
		3					
Europiclon 200	2 - 4.5	1	45 200 92 910	45 200 92 911	C 14 200	CF 200	1.7
		2	45 200 92 920	45 200 92 921			
		3	45 200 92 940	45 200 92 941			
Europiclon 300	3 - 6	1	45 300 92 910	45 300 92 911	C 15 300	CF 300	2.1
		2	45 300 92 920	45 300 92 921			
		3	45 300 92 940	45 300 92 941			
Europiclon 400	4 - 8	1	45 400 92 910	45 400 92 911	C 16 400	CF 400	3.0
		2	45 400 92 920	45 400 92 921			
		3	45 400 92 940	45 400 92 941			
Europiclon 500	6 - 12	1	45 500 92 910	45 500 92 911	C 20 500	CF 500	3.8
		2	45 500 92 920	45 500 92 921			
		3	45 500 92 940	45 500 92 941			
Europiclon 600	7.5 - 15	1	45 600 92 910	45 600 92 911	C 23 610	CF 610	5.0
		2	45 600 92 920	45 600 92 921			
		3	45 600 92 940	45 600 92 941			

### SPECIFICATIONS

Model	Housing material	Dust discharge connection diameter	Tightening torque		Operating temperature		Discharge valve orientation (downwards)
			Hose clamp (clean side)	Screw connection with separate bracket	Continuous	Short-term	
Europiclon	PP-T 20	40 mm (1.57 inches)	ca. 3-5 Nm	15 Nm	-40 °C to +80 °C	+100 °C	±15°

# Europiclon 100-600

## Specifications

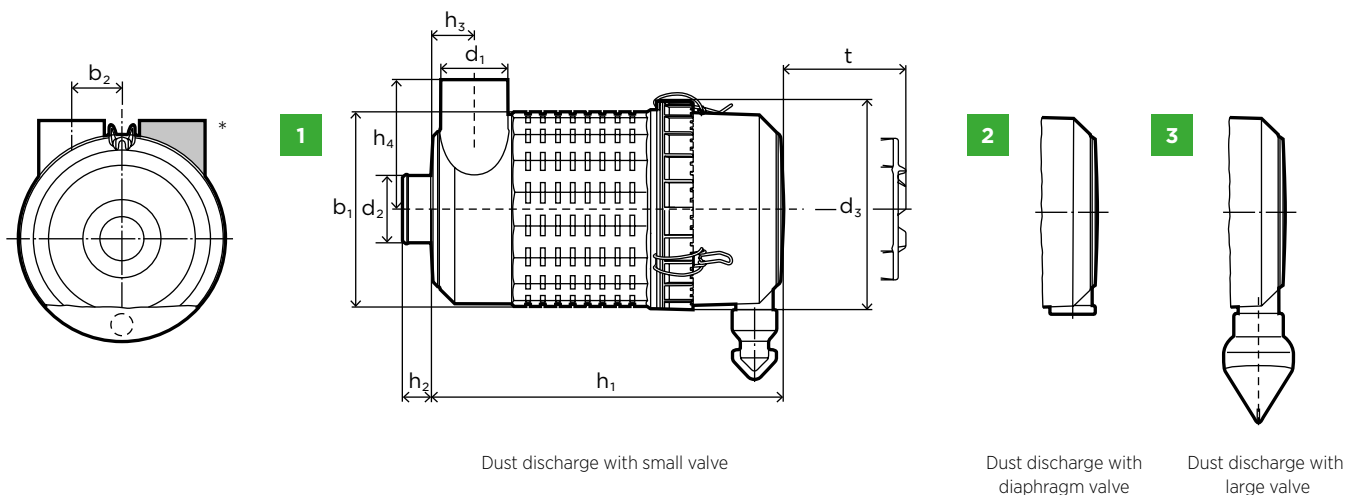

### DIMENSIONS

Model	Figure	Dimensions in mm (dimensions in inches)									
		b <sub>1</sub>	b <sub>2</sub>	d <sub>1</sub>	d <sub>2</sub>	d <sub>3</sub>	h <sub>1</sub>	h <sub>2</sub>	h <sub>3</sub>	h <sub>4</sub>	t
Europiclon 100	1 3	158 (6.22)	45 (1.77)	54 (2.12)	50 (1.97)	185 (7.28)	260 (10.24)	27 (1.06)	38 (1.50)	104 (4.09)	232 (9.13)
Europiclon 200	1 2 3	173 (6.81)	48 (1.89)	62 (2.44)	60 (2.36)	198 (7.80)	327 (12.87)	27 (1.06)	42 (1.65)	112 (4.41)	304 (11.97)
Europiclon 300	1 2 3	203 (7.99)	59 (2.32)	70 (2.76)	70 (2.76)	228 (8.98)	367 (14.45)	30 (1.18)	45 (1.77)	135 (5.32)	344 (13.54)
Europiclon 400	1 2 3	223 (8.78)	63 (2.48)	82 (3.23)	80 (3.15)	248 (9.76)	383 (15.08)	32 (1.26)	52 (2.05)	144 (5.67)	359 (14.13)
Europiclon 500	1 2 3	264 (10.39)	73 (2.87)	102 (4.02)	100 (3.94)	288 (11.34)	408 (16.06)	37 (1.46)	62 (2.44)	174 (6.85)	384 (15.12)
Europiclon 600	1 2 3	295 (11.61)	87 (3.43)	110 (4.33)	110 (4.33)	323 (12.72)	414 (16.30)	27 (1.06)	65 (2.56)	190 (7.48)	384 (15.12)

\* Mirror image version of the raw air inlet available on request.

# Europiclon 100-600

## Flow characteristics

### Europiclon 100

Flow rate

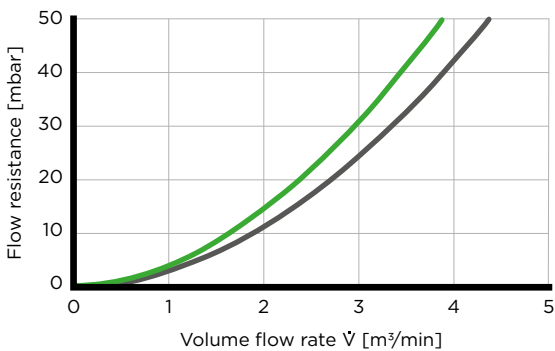

### Europiclon 100

Dust capacity

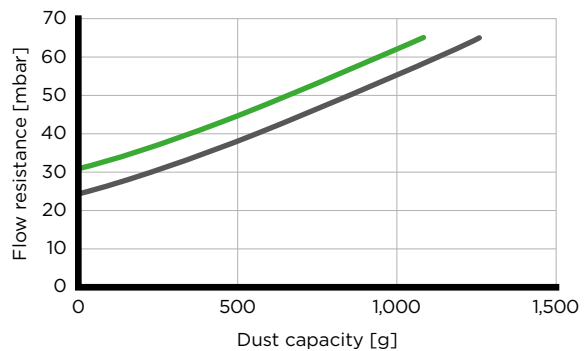

### Europiclon 200

Flow rate

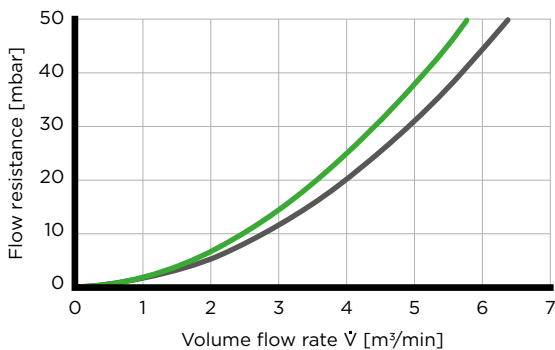

### Europiclon 200

Dust capacity

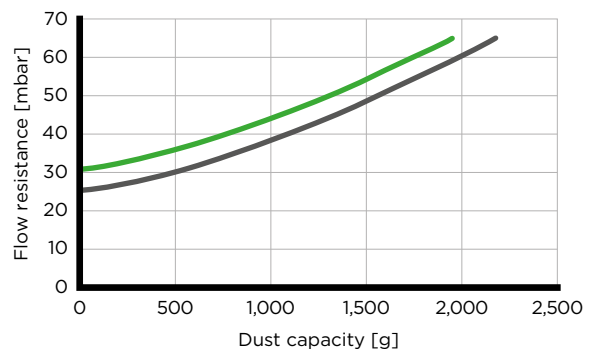

### Europiclon 300

Flow rate

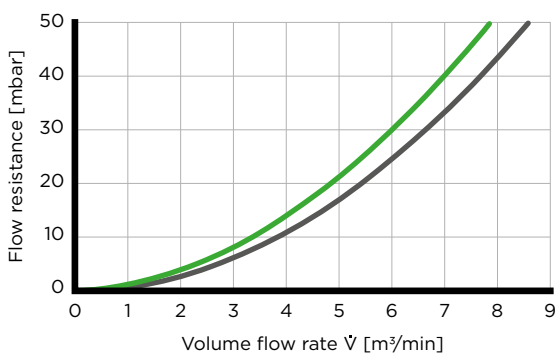

### Europiclon 300

Dust capacity

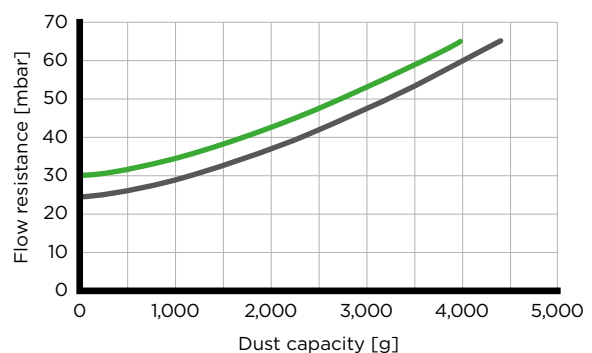

■ With secondary element ■ Without secondary element

Data with scavenging on request.

Flow characteristics measured according to ISO 5011 with ISO coarse at nominal flow rates according to the specifications.



# Europiclon 100-600

## Flow characteristics

### Europiclon 400

Flow rate

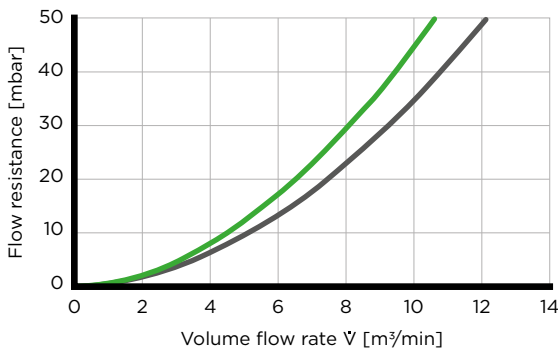

### Europiclon 400

Dust capacity

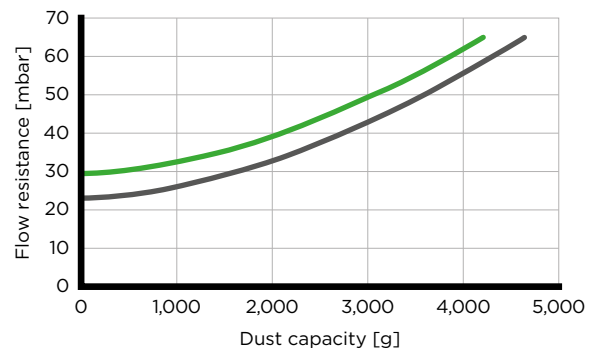

### Europiclon 500

Flow rate

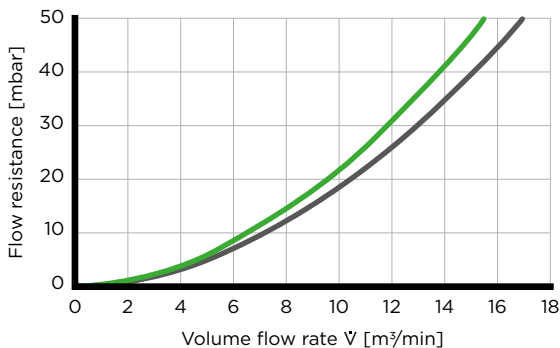

### Europiclon 500

Dust capacity

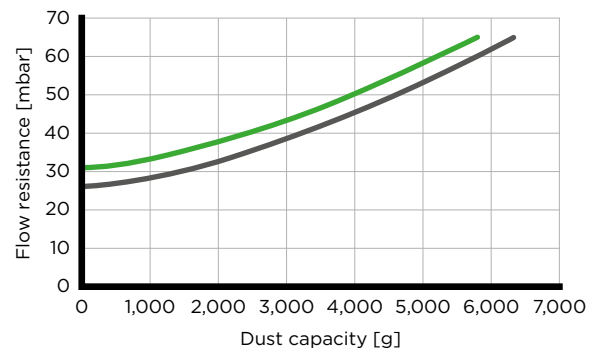

### Europiclon 600

Flow rate

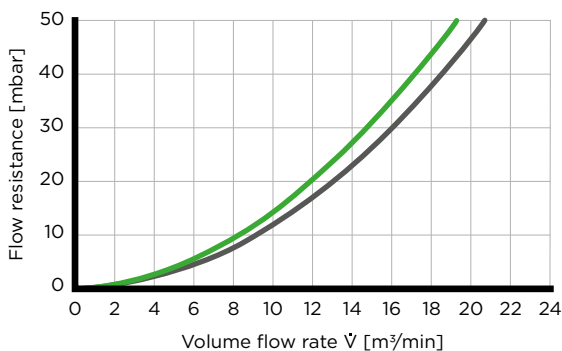

### Europiclon 600

Dust capacity

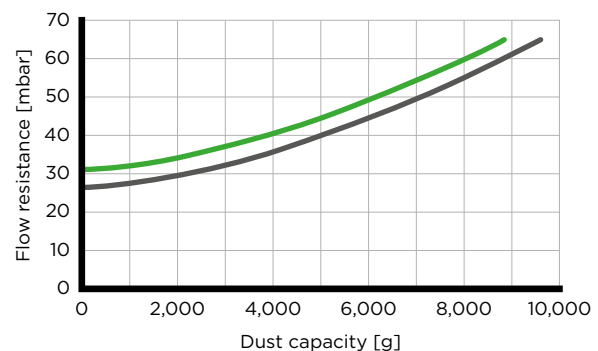

■ With secondary element ■ Without secondary element

Data with scavenging on request.

Flow characteristics measured according to ISO 5011 with ISO coarse at nominal flow rates according to the specifications.

# Europiclon

## Special versions

### EUROPICLON WITH DUST COLLECTOR (SIZES 300 TO 600)

The Europiclon with dust collector is particularly suitable for applications where contamination of the ambient air through dust discharge is to be avoided. For example, this could be a machine in a production area. For these conditions the lower part of the Europiclon housing is equipped with a dust collector and tightly sealed to the environment.

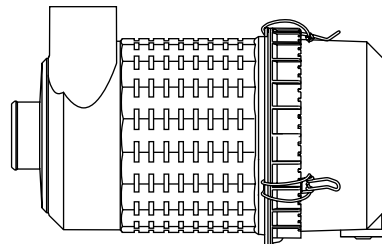

The functionality of the pre-separation process remains uncompromised. The dust is reliably separated into the dust collector and manually emptied from time to time. The service interval depends on the operating conditions.

### PART NUMBERS

Model	Nominal flow rate [m <sup>3</sup> /min]	Part number		Replacement filter element	
		without secondary element	with secondary element	Main element	Secondary element
<b>Europiclon 300</b>	3-6	45 300 92 950	45 300 92 951	C 15 300	CF 300
<b>Europiclon 400</b>	4-8	45 400 92 950	45 400 92 951	C 16 400	CF 400
<b>Europiclon 500</b>	6-12	45 500 92 950	45 500 92 951	C 20 500	CF 500
<b>Europiclon 600</b>	7.5-15	45 600 92 950	45 600 92 951	C 23 610	CF 610

Dimensions are identical for air cleaner types 920/921, see pages 94/95.  
Flow characteristics available on request.

# Europiclon

## Special versions

### EUROPICLON FOR VACUUM APPLICATIONS (SIZES 100 TO 600)

Specially modified air cleaners are available for use with vacuum applications. An additional molded gasket seals the filter. Typical applications are vacuum lifting devices and other negative pressure systems. The pressure tightness is approximately 950 mbar (valid for an ambient temperature of +21 °C).

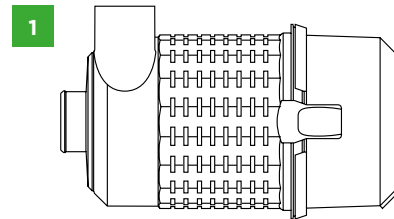

Cover with  
snap fasteners  
(only 44 180 ...)

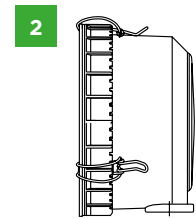

Cover with  
wire clamps  
(45 280 ...  
to 45 680 ...)

### PART NUMBERS

Model	Nominal flow rate [m <sup>3</sup> /min]	Figure	Part number	Replacement filter element
			without secondary element	Main element
<b>Europiclon 100</b>	1-3	1	44 180 92 960	C 11 100
<b>Europiclon 200</b>	2-4.5	2	45 280 92 960	C 14 200
<b>Europiclon 300</b>	3-6	2	45 380 92 960	C 15 300
<b>Europiclon 400</b>	4-8	2	45 480 92 960	C 16 400
<b>Europiclon 500</b>	6-12	2	45 580 92 960	C 20 500
<b>Europiclon 600</b>	7.5-15	2	45 680 92 960	C 23 610

Dimensions are identical for air cleaner types 920/921, see pages 94/95.  
Flow characteristics available on request.

# Europiclon Spare parts



## SPARE PARTS

Model	Replacement part number		
	Small/large valve not fitted	Diaphragm valve fitted	Plug fitted
<b>Europiclon 100</b>	45 100 17 997	-	-
<b>Europiclon 200</b>	45 200 17 997	45 200 17 977	45 200 17 937
<b>Europiclon 300</b>	45 300 17 997	45 300 17 977	45 300 17 937
<b>Europiclon 400</b>	45 400 17 997	45 400 17 977	45 400 17 937
<b>Europiclon 500</b>	45 500 17 997	45 500 17 977	45 500 17 937
<b>Europiclon 600</b>	45 600 17 997	45 600 17 977	45 600 17 937

## DUST DISCHARGE VALVES

Suitable for Europiclon	Part number	Name
<b>45 x00 92 920/921</b>	23 040 30 111	Diaphragm valve
<b>45 x00 92 910/911</b>	39 000 40 391	Dust discharge valve small
<b>44 100 92 940/941</b>	39 000 40 661	Dust discharge valve large/angled
<b>45 x00 92 940/941</b>	39 000 40 102	Dust discharge valve large/straight

x = 1 to 6

# Europiclon Accessories

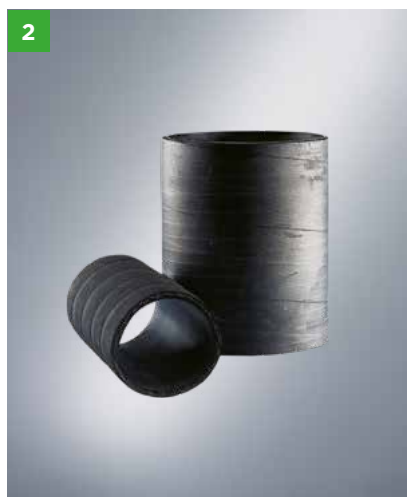

## ACCESSORIES

Model	Rain cap (Page 134)	Straight connection (Page 139)		90 degree elbow (Page 138)	
	Design A <sup>1)</sup> Figure 1	Without connection <sup>2)</sup> Figure 2	With connection <sup>2)</sup> Figure 2	Without connection <sup>2)</sup> Figure 3	With connection <sup>2)</sup> Figure 3
<b>Europiclon 50</b>	39 014 67 910	-	-	-	-
<b>Europiclon 100</b>	39 020 67 910	39 100 27 999	39 100 27 979	39 100 25 999	39 100 25 979
<b>Europiclon 200</b>	39 028 67 910	39 200 27 999	39 200 27 979	39 200 25 999	39 200 25 979
<b>Europiclon 300</b>	39 040 67 910	39 300 27 999	39 300 27 979	39 300 25 999	39 300 25 979
<b>Europiclon 400</b>	39 056 67 910	39 400 27 999	39 400 27 979	39 400 25 999	39 400 25 979
<b>Europiclon 500</b>	39 080 67 910	39 500 27 999	39 500 27 979	39 500 25 999	39 500 25 979
<b>Europiclon 600</b>	39 100 67 910	39 600 27 999	39 600 27 979	39 600 25 999	39 600 25 979

1) Design B possible as alternative (see page 135).

2) For service indicator/switch



### NOTE

The complete range of accessories for our air cleaners can be found starting on page 132.

# Europiclon Accessories (brackets)



## ADVANTAGES

- Flexible installation through many different positions on circumference
- Two possible snap-in positions in axial direction
- Special polygon design ensures secure fitting in the bracket
- Brackets specially designed for the external surface of the Europiclon housing
- Vibration-free mounting of the air cleaner

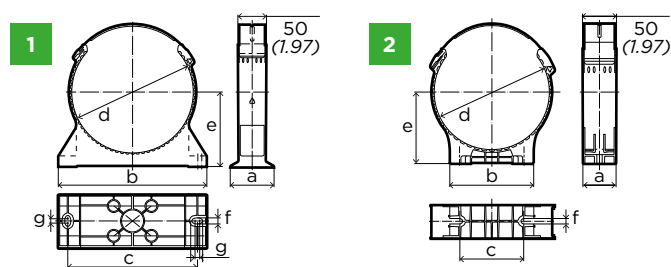

## PART NUMBERS AND DIMENSIONS

Suitable for Europiclon	Part number	Figure	Dimensions in mm (dimensions in inches)						
			a	b	c	d	e	f	g
45 05x 92 ...	39 050 40 959	2	40 (1.57)	137 (5.39)	116 (4.57)	122 (4.80)	85.7 (3.37)	9 (0.35)	-
45 100 92 ...	39 100 40 999	1	60 (2.36)	205 (8.07)	175 (6.89)	156 (6.14)	105 (4.13)	8.5 (0.33)	15.5 (0.61)
45 200 92 ...	39 200 40 999	1	80 (3.15)	220 (8.66)	190 (7.48)	171 (6.73)	110 (4.33)	8.5 (0.33)	15.5 (0.61)
45 300 92 ...	39 300 40 999	1	80 (3.15)	250 (9.84)	220 (8.66)	201 (7.91)	125 (4.92)	8.5 (0.33)	15.5 (0.61)
45 400 92 ...	39 400 40 999	1	80 (3.15)	270 (10.63)	240 (9.45)	221 (8.70)	135 (5.32)	8.5 (0.33)	15.5 (0.61)
45 500 92 ...	39 500 40 999	1	80 (3.15)	310 (12.20)	280 (11.02)	260 (10.24)	155 (6.10)	8.5 (0.33)	15.5 (0.61)
45 600 92 ...	39 600 40 999	1	80 (3.15)	345 (13.58)	315 (12.40)	296 (11.65)	173 (6.81)	8.5 (0.33)	15.5 (0.61)
45 100 92 ...	39 100 40 989	2	50 (1.97)	110 (4.33)	80 (3.15)	156 (6.14)	100 (3.94)	8.5 (0.33)	-
45 200 92 ...	39 200 40 989	2	50 (1.97)	125 (4.92)	95 (3.74)	171 (6.73)	106 (4.17)	8.5 (0.33)	-
45 300 92 ...	39 300 40 989	2	50 (1.97)	140 (5.51)	110 (4.33)	201 (7.91)	121 (4.76)	8.5 (0.33)	-
45 400 92 ...	39 400 40 989	2	50 (1.97)	157 (6.18)	127 (5.00)	221 (8.70)	132 (5.20)	8.5 (0.33)	-
45 500 92 ...	39 500 40 989	2	50 (1.97)	182 (7.17)	152 (5.98)	260 (10.24)	153 (6.02)	8.5 (0.33)	-
45 600 92 ...	39 600 40 969	2	50 (1.97)	182 (7.17)	152 (5.98)	296 (11.65)	173 (6.81)	8.5 (0.33)	-

x = placeholder for corresponding part numbers Europiclon 50 (page 92).







# Piclon

## Two-stage air cleaners with metal housing

The proven two-stage air cleaners of the Piclon range have been an established component of the MANN+HUMMEL range of air cleaners for many years. The air cleaners are particularly robust, have good filtration characteristics and are well suited for use in operating conditions with high dust and mechanical loads. Piclon air cleaners especially find application in quarries, cement plants or mining operations. In addition, the air cleaners are particularly suitable for applications which require a flame resistant housing. An axial tie-rod firmly welded to the housing and a securing nut keep the filter element securely in the sealed position.

### ADVANTAGES

- Robust filter elements with center tubes in metal
- Long service life with low pressure drop
- Especially robust metal design with flame-resistant housing
- Different versions available for dust discharge
- Secondary element available as option

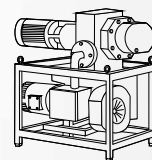
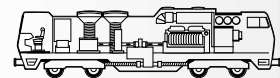

# Piclon

## Part numbers and specifications

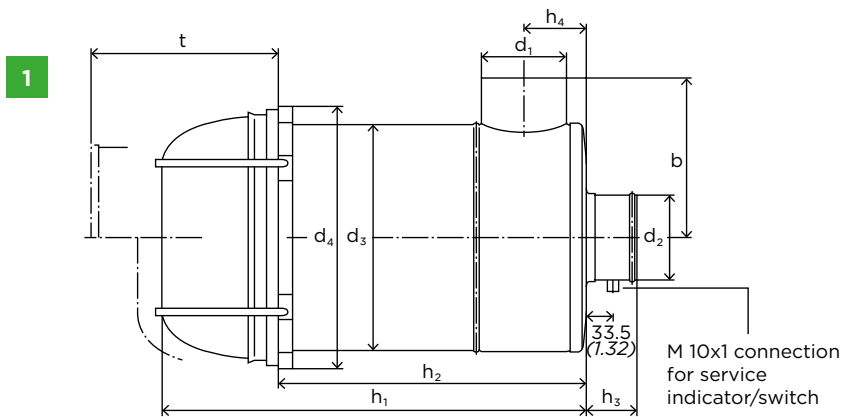

Piclon with dust collector<sup>1)</sup>

### PART NUMBERS

Part number		Nominal flow rate <sup>2)</sup> [m <sup>3</sup> /min]	Replacement filter element		Weight <sup>3)</sup> [kg]
without secondary element	with secondary element		Main element	Secondary element	
<b>45 043 92 304</b>	-	2	C 1043/1	-	1.4
<b>45 043 92 314</b>	-				
<b>45 076 92 304</b>	-	3	C 1176/3	-	2.0
<b>45 076 92 314</b>	-				
<b>45 114 92 304</b>	<b>45 114 92 404</b>	4.5	C 13 114/4	CF 600	3.1
<b>45 114 92 314</b>	<b>45 114 92 414</b>				
<b>45 165 92 304</b>	<b>45 165 92 404</b>	6	C 15 165/3	CF 700	4.5
<b>45 165 92 314</b>	<b>45 165 92 414</b>				
<b>45 225 92 304</b>	<b>45 225 92 404</b>	8	C 17 225/3	CF 800	5.4
<b>45 225 92 314</b>	<b>45 225 92 414</b>				
<b>45 325 92 304</b>	<b>45 325 92 404</b>	12	C 20 325/2	CF 1000	7.2
<b>45 325 92 344</b>	<b>45 325 92 444</b>				
<b>45 440 92 304</b>	<b>45 440 92 404</b>	15	C 23 440/1	CF 1200	9.4
<b>45 440 92 344</b>	<b>45 440 92 444</b>				
<b>45 650 92 304</b>	<b>45 650 92 404</b>	21	C 24 650/1	CF 1300	13.2
<b>45 650 92 344</b>	<b>45 650 92 444</b>				
<b>45 880 92 304</b>	<b>45 880 92 404</b>	28	C 30 850/2	CF 1600	17.5
<b>45 880 92 344</b>	<b>45 880 92 444</b>				
<b>45 920 92 304</b>	<b>45 920 92 404</b>	40	C 33 920/3	CF 2100	26.0
<b>45 920 92 344</b>	<b>45 920 92 444</b>				

1) Dust collector with toggle clip on request

2) Refers to a flow resistance [ $\Delta p$ ] of approximately 20 mbar, for filters with secondary element approximately 30 mbar.

3) Weight applies to version with last digits ... 304, ... 314, ... 344.

# Piclou

## Part numbers and specifications

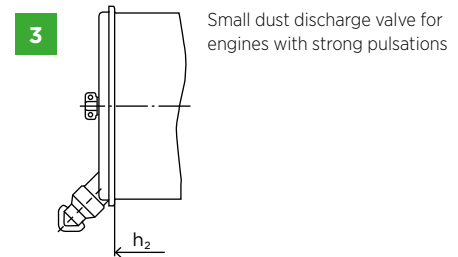
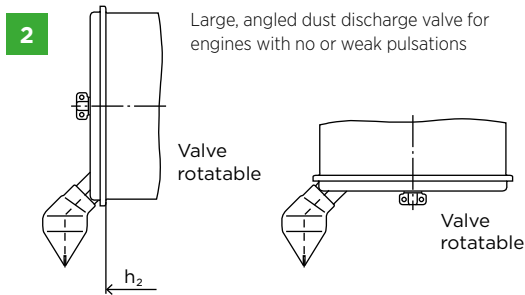

### PART NUMBERS AND DIMENSIONS

Part number		Figure	Dimensions in mm (dimensions in inches)									
without secondary element	with secondary element		b	d <sub>1</sub>	d <sub>2</sub>	d <sub>3</sub>	d <sub>4</sub>	h <sub>1</sub>	h <sub>2</sub>	h <sub>3</sub>	h <sub>4</sub>	t <sup>1)</sup>
<b>45 043 92 304</b>	-	1	90 (3.54)	42 (1.65)	40 (1.57)	120 (4.72)	137 (5.39)	235 (9.25)	172 (6.77)	70 (2.76)	35 (1.38)	190 (7.48)
<b>45 043 92 314<sup>3)</sup></b>	-	3						182 (7.17)				
<b>45 076 92 304</b>	-	1	105 (4.13)	54 (2.13)	50 (1.97)	140 (5.51)	157 (6.18)	247 (9.72)	224 (8.82)	70 (2.76)	45 (1.77)	250 (9.84)
<b>45 076 92 314<sup>3)</sup></b>	-	3										
<b>45 114 92 304</b>	<b>45 114 92 404</b>	1	120 (4.72)	62 (2.44)	60 (2.36)	165 (6.50)	182 (7.17)	314 (12.36)	291 (11.46)	70 (2.76)	50 (1.97)	305 (12.01)
<b>45 114 92 314<sup>3)</sup></b>	<b>45 114 92 414<sup>3)</sup></b>	3										
<b>45 165 92 304</b>	<b>45 165 92 404</b>	1	140 (5.51)	68 (2.68)	70 (2.76)	195 (7.68)	212 (8.35)	358 (14.09)	335 (13.19)	80 (3.15)	55 (2.17)	350 (13.78)
<b>45 165 92 314<sup>3)</sup></b>	<b>45 165 92 414<sup>3)</sup></b>	3										
<b>45 225 92 304</b>	<b>45 225 92 404</b>	1	155 (6.10)	82 (3.23)	80 (3.15)	215 (8.47)	232 (9.13)	444 (17.48)	350 (13.78)	80 (3.15)	65 (2.56)	365 (14.37)
<b>45 225 92 314<sup>3)</sup></b>	<b>45 225 92 414<sup>3)</sup></b>	3						373 (14.69)				
<b>45 325 92 304</b>	<b>45 325 92 404</b>	1	180 (7.09)	102 (4.02)	100 (3.94)	255 (10.04)	272 (10.71)	478 (18.82)	375 (14.76)	90 (3.54)	75 (2.95)	390 (15.35)
<b>45 325 92 344<sup>4)</sup></b>	<b>45 325 92 444<sup>4)</sup></b>	2						399 (15.71)				
<b>45 440 92 304</b>	<b>45 440 92 404</b>	1	205 (8.07)	110 (4.33)	110 (4.33)	290 (11.42)	312 (12.28)	404 (15.91)	380 (14.96)	100 (3.94)	80 (3.15)	405 (15.94)
<b>45 440 92 344<sup>4)</sup></b>	<b>45 440 92 444<sup>4)</sup></b>	2										
<b>45 650 92 304</b>	<b>45 650 92 404</b>	1	230 (9.06)	132 (5.20)	130 (5.12)	320 (12.60)	342 (13.46)	521 (20.51)	495 (19.49)	105 (4.13)	95 (3.74)	515 (20.28)
<b>45 650 92 344<sup>4)</sup></b>	<b>45 650 92 444<sup>4)</sup></b>	2										
<b>45 880 92 304</b>	<b>45 880 92 404</b>	1	280 (11.02)	150 (5.91)	150 (5.91)	385 (15.16)	407 (16.02)	511 (20.12)	474 (18.66)	105 (4.13)	102 (4.02)	495 (19.49)
<b>45 880 92 344<sup>4)</sup></b>	<b>45 880 92 444<sup>4)</sup></b>	2										
<b>45 920 92 304<sup>2)</sup></b>	<b>45 920 92 404<sup>2)</sup></b>	1	305 (12.01)	210 (8.27)	200 (7.87)	420 (16.54)	442 (17.40)	640 (25.20)	615 (24.21)	105 (4.13)	132 (5.20)	635 (25.00)
<b>45 920 92 344<sup>4)</sup></b>	<b>45 920 92 444<sup>4)</sup></b>	2										

1) Removal depth of the filter elements

2) Dust collector only with toggle clip

3) Large dust discharge valve angled available as accessory; part no. 39 000 40 661

4) Small dust discharge valve available as accessory; part no. 39 000 40 391

# Piclon

## Flow characteristics

### Piclon 45 043 ...

Flow rate

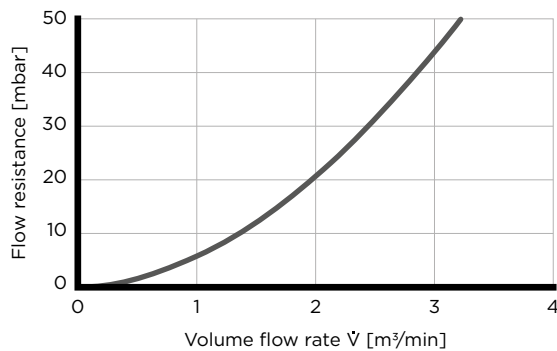

### Piclon 45 043 ...

Dust capacity

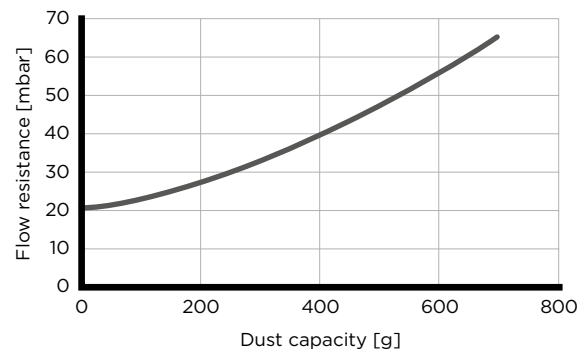

### Piclon 45 076 ...

Flow rate

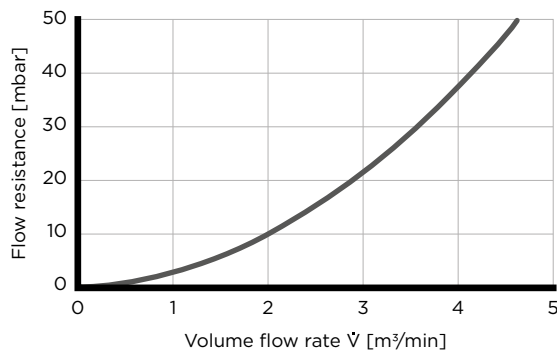

### Piclon 45 076 ...

Dust capacity

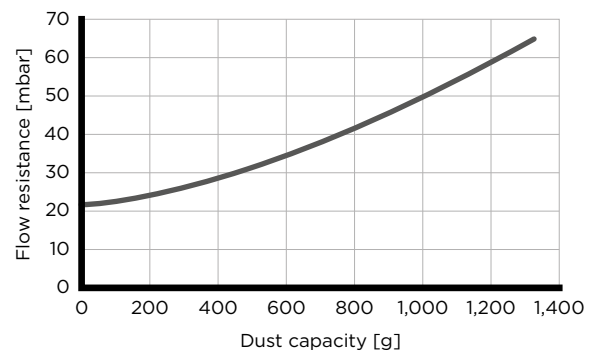

### Piclon 45 114 ...

Flow rate

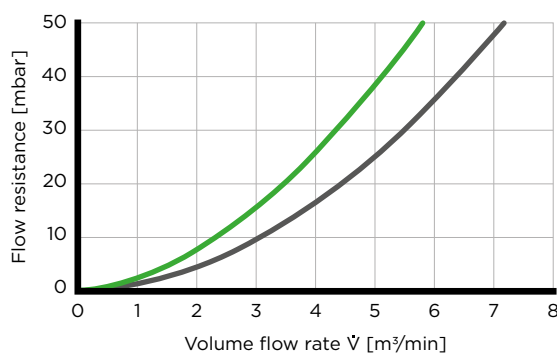

### Piclon 45 114 ...

Dust capacity

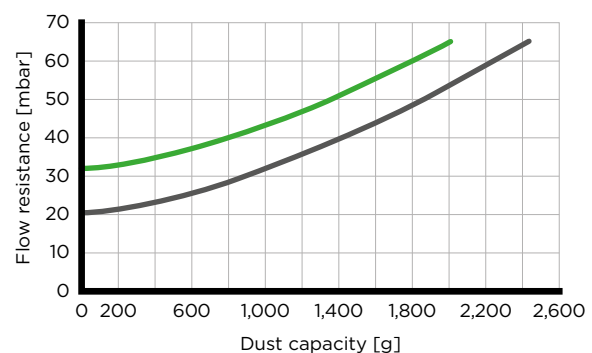

■ With secondary element ■ Without secondary element

Data with scavenging on request.

Flow characteristics measured according to ISO 5011 with ISO coarse at nominal flow rates according to the specifications.

# Piclou

## Flow characteristics

### Piclou 45 165 ...

Flow rate

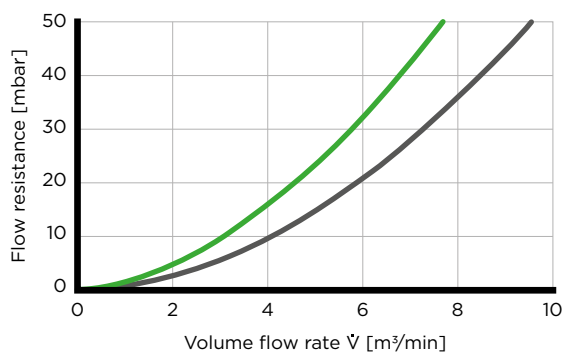

### Piclou 45 165 ...

Dust capacity

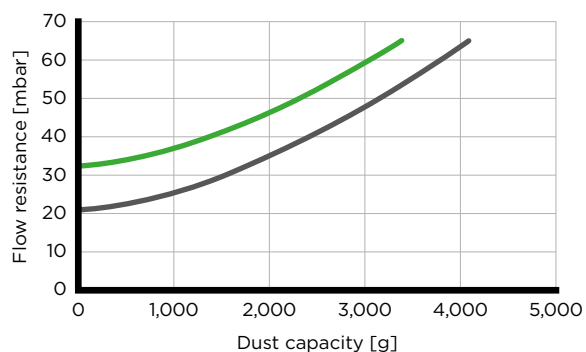

### Piclou 45 225 ...

Flow rate

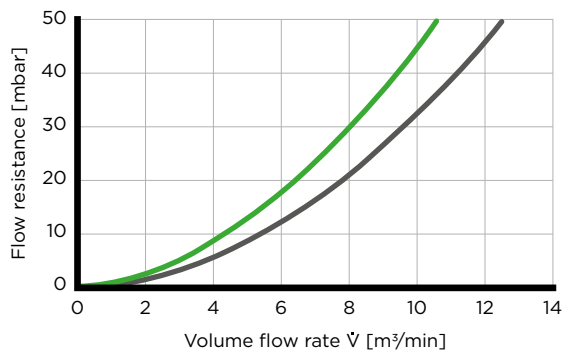

### Piclou 45 225 ...

Dust capacity

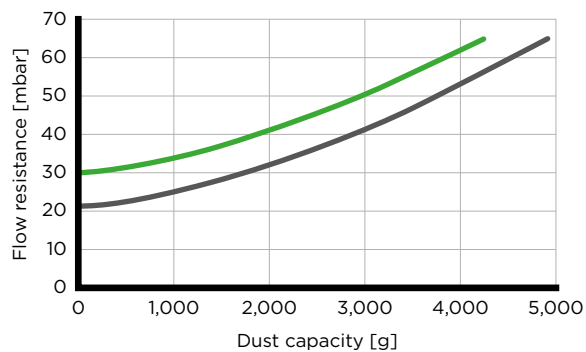

### 45 325 ...

Flow rate

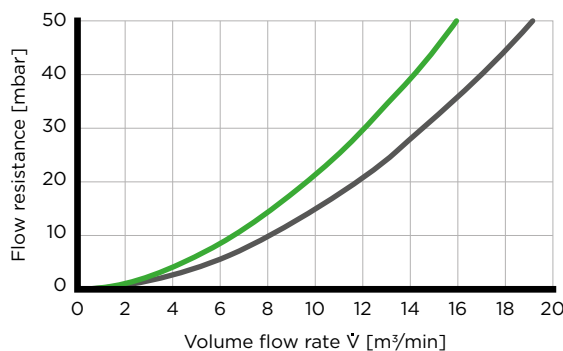

### 45 325 ...

Dust capacity

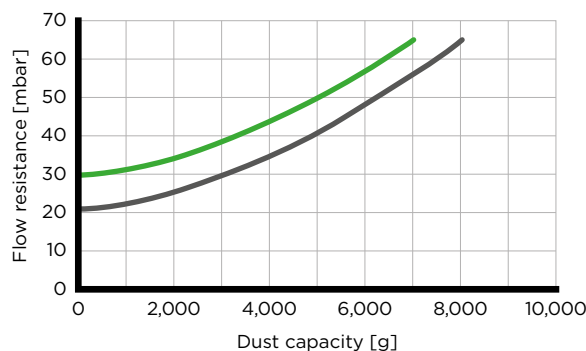

■ With secondary element ■ Without secondary element

Data with scavenging on request.

Flow characteristics measured according to ISO 5011 with ISO coarse at nominal flow rates according to the specifications.

# Piclon

## Flow characteristics

### Piclon 45 440 ...

Flow rate

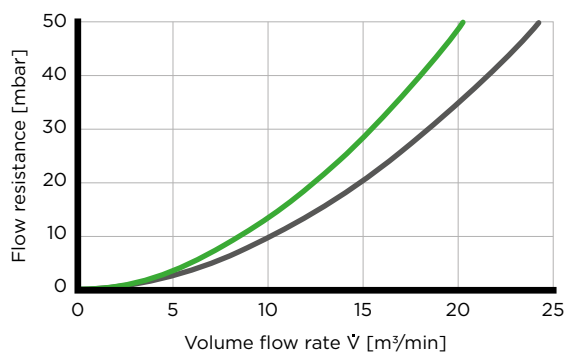

### Piclon 45 440 ...

Dust capacity

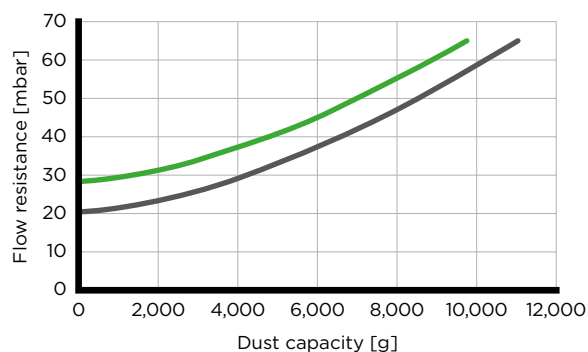

### Piclon 45 650 ...

Flow rate

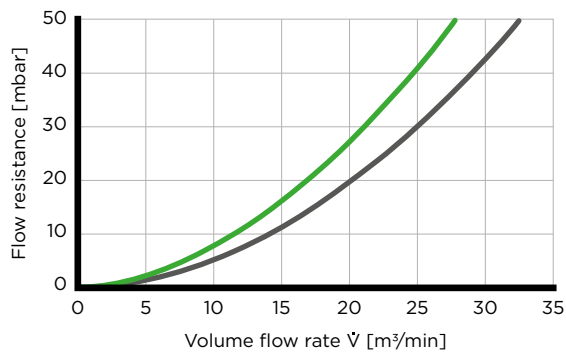

### Piclon 45 650 ...

Dust capacity

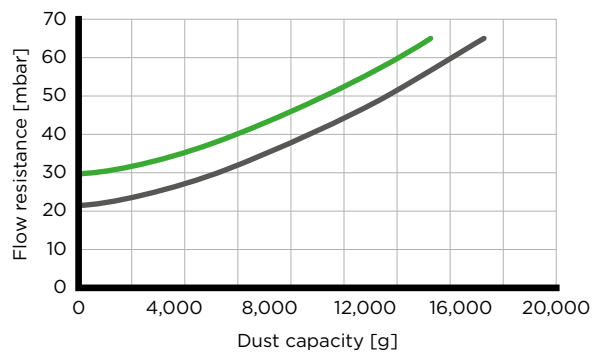

■ With secondary element ■ Without secondary element

Data with scavenging on request.

Flow characteristics measured according to ISO 5011 with ISO coarse at nominal flow rates according to the specifications.

# Piclon

## Flow characteristics

### Piclon 45 880 ...

Flow rate

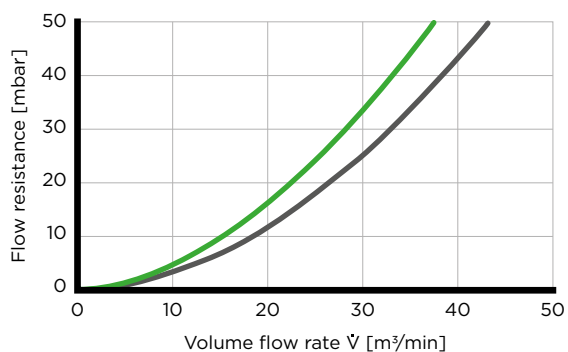

### Piclon 45 880 ...

Dust capacity

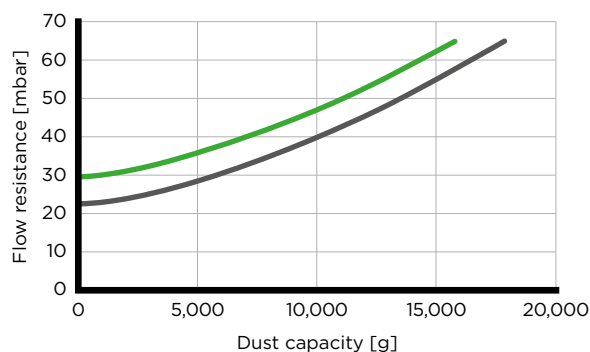

### Piclon 45 920 ...

Flow rate

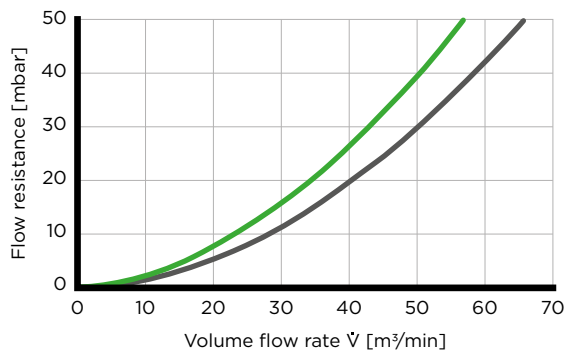

### Piclon 45 920 ...

Dust capacity

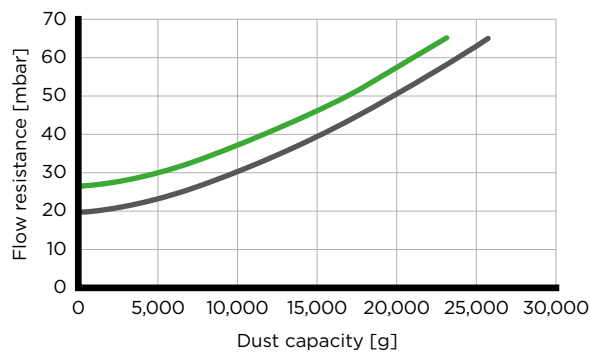

■ With secondary element ■ Without secondary element

Data with scavenging on request.

Flow characteristics measured according to ISO 5011 with ISO coarse at nominal flow rates according to the specifications.

# Piclon Accessories



## ACCESSORIES

Model	Rain cap (Page 134)		Straight connection <sup>1)</sup> (Page 139) Figure 3	90 degree elbow <sup>1)</sup> (Page 138) Figure 4
	Design A Figure 1	Design B Figure 2		
Piclon 45 043 ...	39 014 67 910	39 014 67 900	-	-
Piclon 45 076 ...	39 020 67 910	39 020 67 900	39 100 27 999	39 100 25 999
Piclon 45 114 ...	39 028 67 910	39 028 67 900	39 200 27 999	39 200 25 999
Piclon 45 165 ...	39 040 67 910	39 040 67 900	39 300 27 999	39 300 25 999
Piclon 45 225 ...	39 056 67 910	39 056 67 900	39 400 27 999	39 400 25 999
Piclon 45 325 ...	39 080 67 910	39 080 67 900	39 500 27 999	39 500 25 999
Piclon 45 440 ...	39 100 67 910	39 100 67 910	39 600 27 999	39 600 25 999
Piclon 45 650 ...	39 160 67 910	39 160 67 910	39 700 27 999	39 700 25 999
Piclon 45 880 ...	39 190 67 910	39 190 67 910	39 800 27 999	39 800 25 999
Piclon 45 920 ...	39 370 67 910	39 370 67 910	39 000 27 345	39 000 25 270

1) Connection for service switch and indicator integrated in housing.

## DUST DISCHARGE VALVES

Suitable for Piclon	Part number	Name
... 314 + ... 414	39 000 40 391	Small dust discharge valve
... 344 + ... 444	39 000 40 661	Large/angled dust discharge valve



### NOTE

The complete range of accessories for our air cleaners can be found starting on page 132.



# Piclou

## Accessories (brackets)

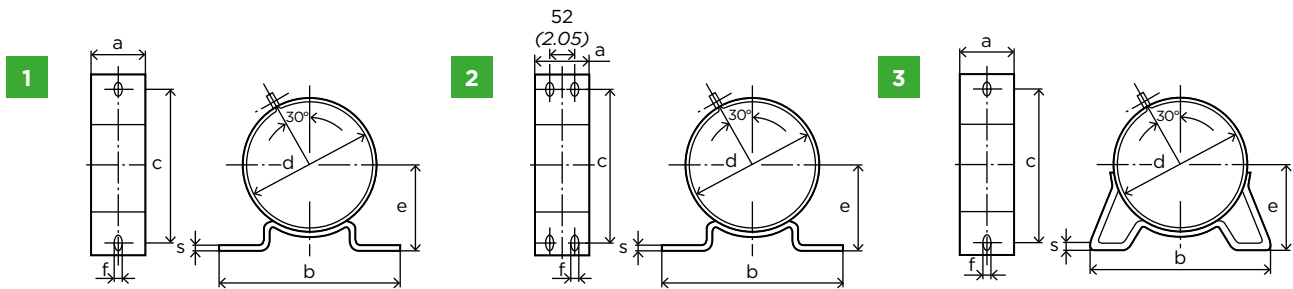

### PART NUMBERS AND DIMENSIONS

Suitable for Piclou	Part number	Figure	Dimensions in mm (dimensions in inches)							Weight [kg]
			a	b	c	d	e	f	s	
45 043 92...	39 014 38 990	1	40 (1.57)	170 (6.69)	130 (5.12)	120 (4.72)	70 (2.76)	12 (0.47)	2.5 (0.10)	0.6
45 076 92...	39 076 38 970	1	20 (0.79)	190 (7.48)	150 (5.91)	140 (5.51)	80 (3.15)	12 (0.47)	3 (0.12)	0.3
45 114 92...	39 114 38 970	1	20 (0.79)	220 (8.66)	180 (7.09)	165 (6.50)	100 (3.94)	12 (0.47)	3 (0.12)	0.3
45 165 92...	39 165 38 970	1	40 (1.57)	240 (9.45)	200 (7.87)	195 (7.68)	125 (4.92)	12 (0.47)	3 (0.12)	0.6
45 225 92...	39 225 38 970	1	40 (1.57)	240 (9.45)	200 (7.87)	215 (8.46)	130 (5.12)	12 (0.47)	3 (0.12)	0.6
45 325 92...	39 325 38 970	1	40 (1.57)	280 (11.02)	240 (9.45)	255 (10.04)	145 (5.71)	14 (0.55)	3 (0.12)	0.8
45 440 92...	39 440 38 970	1	40 (1.57)	310 (12.20)	270 (10.63)	290 (11.42)	165 (6.50)	14 (0.55)	3 (0.12)	0.9
45 440 92...	39 440 38 941	3	40 (1.57)	322 (12.68)	270 (10.63)	290 (11.42)	165 (6.50)	14 (0.55)	3 (0.12)	1.0
45 650 92...	39 120 38 980	1	40 (1.57)	310 (12.20)	270 (10.63)	320 (12.60)	185 (7.28)	14 (0.55)	3 (0.12)	1.0
45 650 92...	45 650 38 761	3	40 (1.57)	322 (12.68)	270 (10.63)	320 (12.60)	185 (7.28)	14 (0.55)	3 (0.12)	1.1
45 880 92...	39 880 38 990	3	40 (1.57)	340 (13.39)	270 (10.63)	385 (15.16)	220 (8.66)	14 (0.55)	3 (0.12)	1.0
45 920 92...	45 920 38 990	2	80 (3.15)	420 (16.54)	380 (14.96)	420 (16.54)	235 (9.25)	14 (0.55)	3 (0.12)	2.3

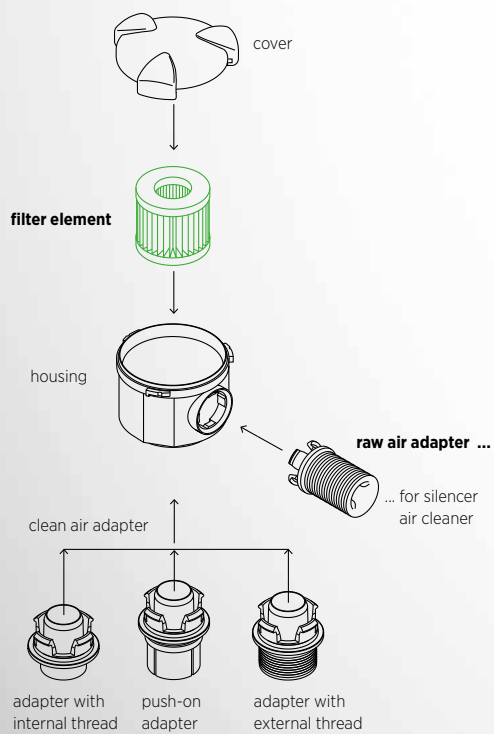

# Picolino

## The compact system for high requirements

The Picolino range from MANN+HUMMEL offers excellent filter characteristics in a compact installation space. The modular system consists of basic housings and a selection of adapters and filter elements which allows it to be flexibly adapted to the respective customer requirements. The Picolino range is available with a number of different connections and, for example, is used as a silencer air cleaner for low noise air intake, as an intake air cleaner for small piston compressors and small engines (e.g. lawnmowers, emergency generators, etc.) and as a two-way ventilation air cleaner for gearboxes and liquid tanks.

### ADVANTAGES

- Economic air cleaner system through combination of standard parts
- Variable modular system for excellent flexibility
- Easy element change without tools
- Corrosion-free, robust housing through use of plastic reinforced with glass fiber
- Cr(VI)-free components
- Temperature-resistant to +120 °C (short-term)
- Environmentally-friendly and economical disposal through filter elements which are metal-free and fully incinerable
- Radial seal with elastomer end plates

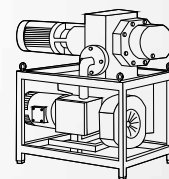
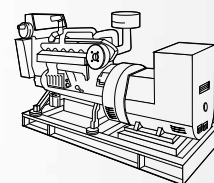
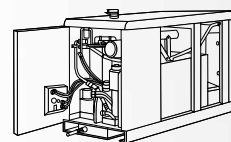

# Picolino intake variants

## Part numbers and specifications

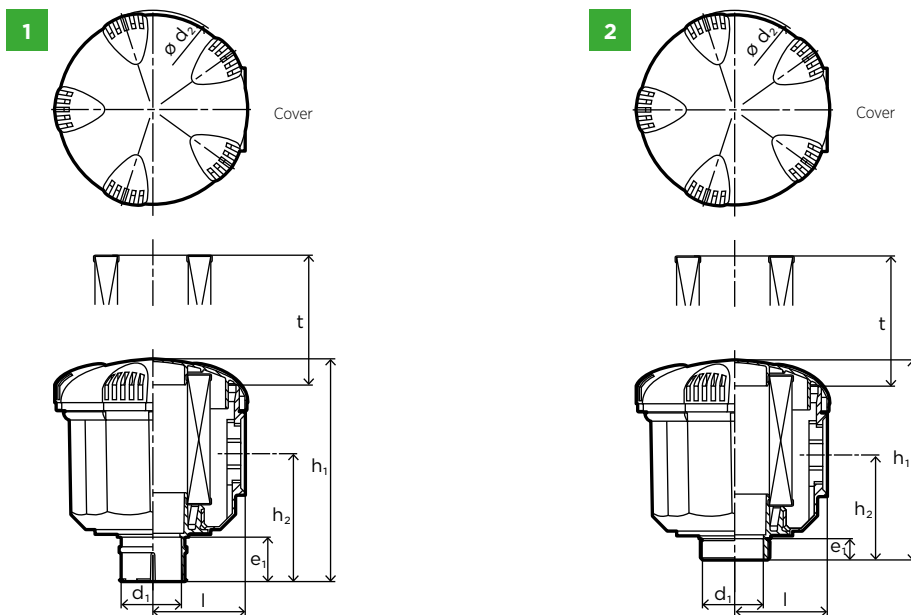

### PART NUMBERS AND DIMENSIONS

Part number	Application area		Figure	Dimensions in mm ( <i>dimensions in inches</i> )							Part number
	Nominal flow rate [m <sup>3</sup> /min]	at Δp [mbar]		d <sub>1</sub>	d <sub>2</sub>	e <sub>1</sub>	h <sub>1</sub>	h <sub>2</sub>	l	t	Main element
44 010 72 996	0.25	15	2	G 1/2 <sup>1)</sup>	58 (2.28)	14 (0.55)	61 (2.40)	34 (1.34)	27 (1.06)	30 (1.18)	C 410
44 010 72 997	0.2	12	2	G 3/8 <sup>1)</sup>	58 (2.28)	11 (0.43)	61 (2.40)	34 (1.34)	27 (1.06)	30 (1.18)	C 410
44 010 72 999	0.2	11	2	M 18x1.5 <sup>2)</sup>	58 (2.28)	11 (0.43)	61 (2.40)	34 (1.34)	27 (1.06)	30 (1.18)	C 410
44 020 72 996	0.25	13	2	G 1/2 <sup>1)</sup>	68 (2.68)	14 (0.55)	62 (2.44)	34 (1.34)	31 (1.22)	30 (1.18)	C 420
44 020 72 997	0.25	15	2	G 3/8 <sup>1)</sup>	68 (2.68)	11 (0.43)	62 (2.44)	34 (1.34)	31 (1.22)	30 (1.18)	C 420
44 020 72 999	0.2	16	2	M 18x1.5 <sup>2)</sup>	68 (2.68)	11 (0.43)	62 (2.44)	34 (1.34)	31 (1.22)	30 (1.18)	C 420
44 030 72 999	0.8	16	2	G 3/4 <sup>1)</sup>	102 (4.02)	15 (0.59)	94 (3.70)	45 (1.77)	48 (1.89)	68 (2.68)	C 630
44 030 77 997	1.2	15	1	40 (1.57)	102 (4.02)	25 (0.98)	116 (4.57)	67 (2.64)	48 (1.89)	68 (2.68)	C 630
44 030 77 998	1.2	16	1	30 (1.18)	102 (4.02)	23 (0.91)	116 (4.57)	67 (2.64)	48 (1.89)	68 (2.68)	C 630

1) Internal thread  
2) External thread

# Picolino intake variants

## Part numbers and specifications

### PART NUMBERS AND DIMENSIONS

Part number	Application area		Figure	Dimensions in mm ( <i>dimensions in inches</i> )						Part number	
	Nominal flow rate [m <sup>3</sup> /min]	at Δp [mbar]		d <sub>1</sub>	d <sub>2</sub>	e <sub>1</sub>	h <sub>1</sub>	h <sub>2</sub>	l	t	Main element
<b>44 040 77 996</b>	3.0	15	1	71 (2.8)	145 (5.71)	25 (0.98)	136 (5.35)	76 (2.99)	69 (2.72)	79 (3.11)	C 1140
<b>44 040 77 997</b>	2.8	15	1	60 (2.36)	145 (5.71)	25 (0.98)	136 (5.35)	76 (2.99)	69 (2.72)	79 (3.11)	C 1140
<b>44 040 77 998</b>	2.6	15	1	52 (2.05)	145 (5.71)	25 (0.98)	136 (5.35)	76 (2.99)	69 (2.72)	79 (3.11)	C 1140
<b>44 040 77 999</b>	2.1	15	1	40 (1.57)	145 (5.71)	25 (0.98)	136 (5.35)	76 (2.99)	69 (2.72)	79 (3.11)	C 1140
<b>44 050 72 999</b>	2.3	15	2	G 1 1/4 <sup>1)</sup>	181 (7.13)	19 (0.75)	188 (7.40)	112 (4.41)	85 (3.35)	135 (5.32)	C 1250
<b>44 050 77 996</b>	3.5	15	1	71 (2.8)	181 (7.13)	25 (0.98)	193 (7.60)	115 (4.53)	85 (3.35)	135 (5.32)	C 1250
<b>44 050 77 997</b>	3.4	15	1	60 (2.36)	181 (7.13)	25 (0.98)	193 (7.60)	115 (4.53)	85 (3.35)	135 (5.32)	C 1250
<b>44 050 77 998</b>	3.1	15	1	52 (2.05)	181 (7.13)	25 (0.98)	193 (7.60)	115 (4.53)	85 (3.35)	135 (5.32)	C 1250
<b>44 050 77 999</b>	2.3	15	1	40 (1.57)	181 (7.13)	25 (0.98)	193 (7.60)	115 (4.53)	85 (3.35)	135 (5.32)	C 1250

1) Internal thread

# Picolino silencer variants

## Part numbers and specifications

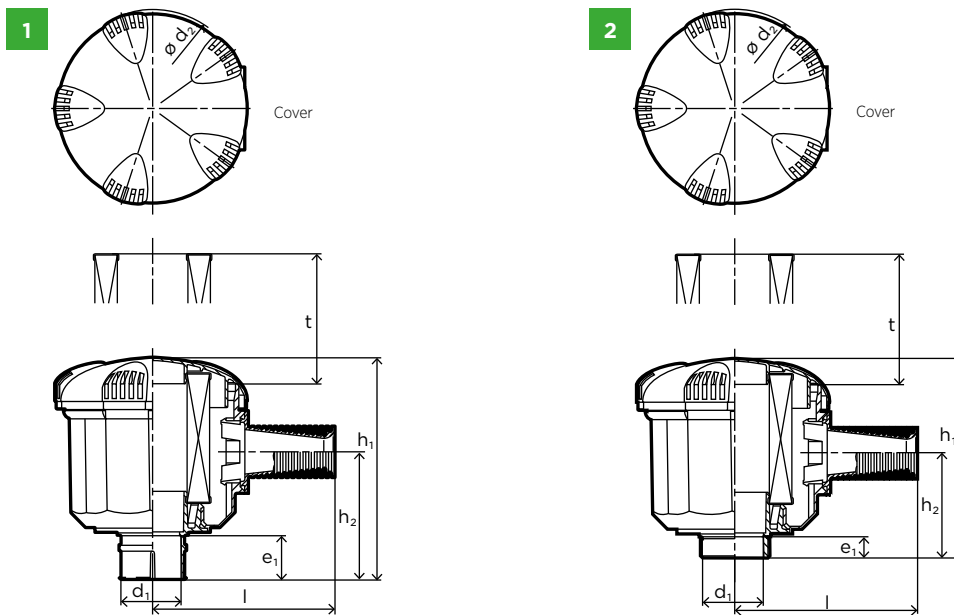

### PART NUMBERS AND DIMENSIONS

Part number	Application area		Figure	Dimensions in mm ( <i>dimensions in inches</i> )							Part number
	Nominal flow rate [m <sup>3</sup> /min]	at Δp [mbar]		d <sub>1</sub>	d <sub>2</sub>	e <sub>1</sub>	h <sub>1</sub>	h <sub>2</sub>	l	t	Main element
44 010 82 996	0.15	17	2	G 1/2 <sup>1)</sup>	58 (2.28)	14 (0.55)	61 (2.40)	34 (1.34)	55 (2.17)	30 (1.18)	C 410
44 010 82 997	0.15	17	2	G 3/8 <sup>1)</sup>	58 (2.28)	11 (0.43)	61 (2.40)	34 (1.34)	55 (2.17)	30 (1.18)	C 410
44 010 82 999	0.15	17	2	M 18x1.5 <sup>2)</sup>	58 (2.28)	11 (0.43)	61 (2.40)	34 (1.34)	55 (2.17)	30 (1.18)	C 410
44 020 82 996	0.15	11	2	G 1/2 <sup>1)</sup>	68 (2.68)	14 (0.55)	62 (2.44)	34 (1.34)	60 (2.36)	30 (1.18)	C 420
44 020 82 997	0.15	12	2	G 3/8 <sup>1)</sup>	68 (2.68)	11 (0.43)	62 (2.44)	34 (1.34)	60 (2.36)	30 (1.18)	C 420
44 020 82 999	0.15	11	2	M 18x1.5 <sup>2)</sup>	68 (2.68)	11 (0.43)	62 (2.44)	34 (1.34)	60 (2.36)	30 (1.18)	C 420
44 030 82 999	0.6	15	2	G 3/4 <sup>1)</sup>	102 (4.02)	15 (0.59)	94 (3.70)	45 (1.77)	95 (3.74)	68 (2.68)	C 630
44 030 87 997	0.8	17	1	40 (1.57)	102 (4.02)	25 (0.98)	116 (4.57)	67 (2.64)	95 (3.74)	68 (2.68)	C 630
44 030 87 998	0.8	16	1	30 (1.18)	102 (4.02)	23 (0.91)	116 (4.57)	67 (2.64)	95 (3.74)	68 (2.68)	C 630

1) Internal thread  
2) External thread

# Picolino silencer variants

## Part numbers and specifications

### PART NUMBERS AND DIMENSIONS

Part number	Application area		Figure	Dimensions in mm ( <i>dimensions in inches</i> )						Part number	
	Nominal flow rate [m <sup>3</sup> /min]	at Δp [mbar]		d <sub>1</sub>	d <sub>2</sub>	e <sub>1</sub>	h <sub>1</sub>	h <sub>2</sub>	l	t	Main element
<b>44 040 82 999</b>	1.7	15	2	G 1 1/4 <sup>1)</sup>	145 (5.71)	19 (0.75)	131 (5.16)	71 (2.80)	122 (4.80)	79 (3.11)	C 1140
<b>44 040 87 996</b>	2.0	15	1	71 (2.8)	145 (5.71)	25 (0.98)	136 (5.35)	76 (2.99)	122 (4.80)	79 (3.11)	C 1140
<b>44 040 87 997</b>	2.0	15	1	60 (2.36)	145 (5.71)	25 (0.98)	136 (5.35)	76 (2.99)	122 (4.80)	79 (3.11)	C 1140
<b>44 040 87 998</b>	1.9	15	1	52 (2.05)	145 (5.71)	25 (0.98)	136 (5.35)	76 (2.99)	122 (4.80)	79 (3.11)	C 1140
<b>44 040 87 999</b>	1.6	14	1	40 (1.57)	145 (5.71)	25 (0.98)	136 (5.35)	76 (2.99)	122 (4.80)	79 (3.11)	C 1140
<b>44 050 82 999</b>	2.0	15	2	G 1 1/4 <sup>1)</sup>	181 (7.13)	19 (0.75)	188 (7.40)	112 (4.41)	144 (5.67)	135 (5.32)	C 1250
<b>44 050 87 996</b>	2.8	15	1	71 (2.8)	181 (7.13)	25 (0.98)	193 (7.60)	115 (4.53)	144 (5.67)	135 (5.32)	C 1250
<b>44 050 87 997</b>	2.8	15	1	60 (2.36)	181 (7.13)	25 (0.98)	193 (7.60)	115 (4.53)	144 (5.67)	135 (5.32)	C 1250
<b>44 050 87 998</b>	2.5	15	1	52 (2.05)	181 (7.13)	25 (0.98)	193 (7.60)	115 (4.53)	144 (5.67)	135 (5.32)	C 1250
<b>44 050 87 999</b>	2.0	15	1	40 (1.57)	181 (7.13)	25 (0.98)	193 (7.60)	115 (4.53)	144 (5.67)	135 (5.32)	C 1250

1) Internal thread





# Picolight

## Single-stage air cleaners without housing

The metal-free Picolight air cleaners from MANN+HUMMEL are characterized by an especially low weight and compact design. We particularly recommend these air cleaners for stationary applications with low dust loads such as generators, compressors or marine engines. Filter media with the well-known MANN+HUMMEL quality are also used in the Picolight to achieve high efficiency and performance.

### ADVANTAGES

- Single-stage air cleaner with low pressure drop
- Particularly economic through simple design
- Compact and light construction without separate housing
- Environmentally-friendly disposal through filter elements which are metal-free and fully incinerable
- Reliable filtration performance
- Cr(VI)-free components
- Easy installation with hose clamp

### TECHNICAL NOTES

The Picolight is recommended for use in installation areas which are enclosed or protected against humidity. A hose clamp is required to mount the air cleaner.

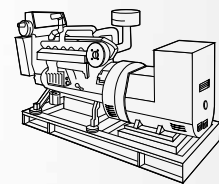
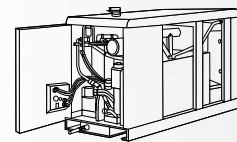

1) Exceptions see page 122

# Picolight

## Part numbers and specifications

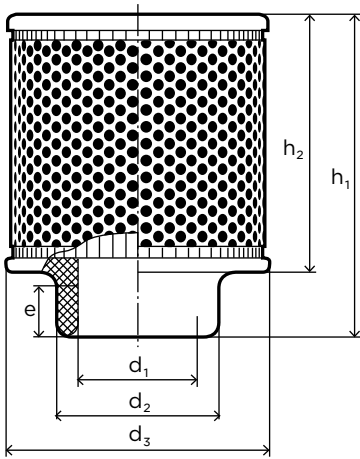

### PART NUMBERS AND DIMENSIONS

Part number	Application area		Dimensions in mm ( <i>dimensions in inches</i> )						Weight [kg]	Part number Hose clamp
	Nominal flow rate [m <sup>3</sup> /min]	at $\Delta p$ [mbar]	$d_1$	$d_2$	$d_3$	$h_1$	$h_2$	$e$		
<b>C 1131</b>	3.3	10	50 (1.97)	67 (2.64)	110 (4.33)	120 (4.72)	95 (3.74)	15 (0.59)	0.16	02 018 01 709
<b>C 1368</b>	6.8	10	76 (2.99)	91 (3.58)	130 (5.12)	150 (5.91)	125 (4.92)	20 (0.79)	0.24	02 018 01 712
<b>C 17 100</b>	7.7	10	76 (2.99)	91 (3.58)	160 (6.30)	164 (6.46)	139 (5.47)	20 (0.79)	0.38	02 018 01 712
<b>C 23 174</b>	12.5	10	100 (3.94)	117 (4.61)	230 (9.06)	155 (6.10)	120 (4.72)	25 (0.98)	0.68	02 018 01 715
<b>C 31 1195<sup>1)</sup></b>	40	6	199 (7.83)	210 (8.27)	318 (12.52)	444 (17.48)	400 (15.75)	30 (1.18)	3.3	02 018 01 724
<b>C 31 1195/1<sup>1)</sup></b>	40	6	199 (7.83)	210 (8.27)	318 (12.52)	444 (17.48)	400 (15.75)	30 (1.18)	3.2	02 018 01 724
<b>C 43 1090/1</b>	80	10	252 (9.92)	254 (10.00)	425 (16.73)	404 (15.91)	335 (13.19)	25 (0.98)	5.6	02 018 01 728

1) Particularly robust design with metal.





# Vacuum air cleaners

## Proven solutions for vacuum technology

**The negative-pressure resistant vacuum air cleaners from MANN+HUMMEL reliably protect components such as vacuum pumps and machines against contamination from intake dust and aerosols. Vacuum air cleaners are designed for installation in air and gas pipes and are used, for example, as intake air cleaners. They are airtight up to 950 mbar negative pressure and equipped with an efficient filter element.**

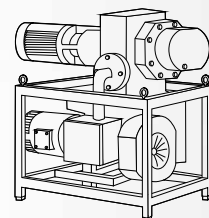

### ADVANTAGES

- Airtight and pressure-resistant up to 950 mbar negative pressure
- Robust metal design
- Different connections available
- Excellent filtration performance
- Stable, robust design
- Suitable filter elements for the respective application

### TECHNICAL NOTES

The nominal flow rate of the air cleaner determines the air cleaner size. The air cleaner size is to be selected so that the nominal flow rate of the air cleaner is equal or greater than the air requirement. The air cleaner can be installed in a vertical or horizontal installation position. However, the air cleaner should not be mounted with the clean air outlet at the bottom as otherwise dirt can enter the clean air pipe during service.

# Vacuum air cleaners

## Part numbers and specifications

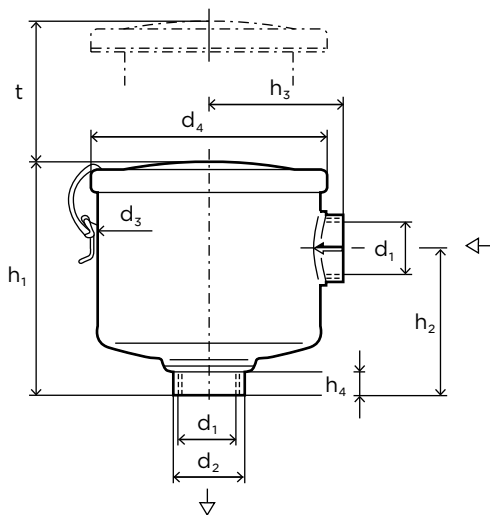

### PART NUMBERS AND DIMENSIONS

Part number	Application area		Dimensions in mm ( <i>dimensions in inches</i> )									Weight [kg]	Part number Main element
	Nominal flow rate [m <sup>3</sup> /min]	at $\Delta p$ [mbar]	$d_1$	$d_2$	$d_3$	$d_4$	$h_1$	$h_2$	$h_3$	$h_4$	$t$		
45 009 72 105	0.7	11	G 3/4	35 (1.38)	90 (3.54)	97 (3.82)	89 (3.50)	45 (1.77)	59 (2.32)	6 (0.24)	70 (2.76)	0.6	C 75
45 021 72 105	1.6	10	G 1 1/4	50 (1.97)	125 (4.92)	136 (5.35)	116 (4.57)	68 (2.68)	81 (3.19)	17 (0.67)	75 (2.95)	1.0	C 1112
45 037 72 105	1.8	10	G 1 1/4	50 (1.97)	162 (6.38)	172 (6.77)	170 (6.69)	108 (4.25)	98 (3.86)	17 (0.67)	130 (5.12)	1.5	C 1337
45 124 72 104	6.0	12	G 2 1/2	86 (3.39)	194 (7.64)	200 (7.87)	250 (9.84)	129 (5.08)	123 (4.84)	10 (0.39)	240 (9.45)	4.3	C 15 124/1

Further filter elements available on request.







# Special air cleaners

## Tank two-way ventilation air cleaners

**Two-way ventilation air cleaners from MANN+HUMMEL ensure that during the pressure compensation of liquid tanks and gearboxes there is no contamination from incoming particles. With a filtration performance of over 99.5 percent the purity class of the fuel can be reliably maintained.**

**As an option, metal-free air cleaners of the Picolino range (page 114) can be used.**

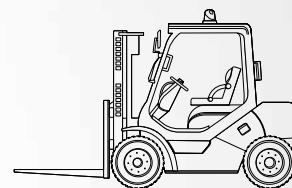

### ADVANTAGES

- Single-stage air cleaners for low flow resistance
- Two types available (with or without pressure control valve)
- Volume flow rates possible up to 15 m<sup>3</sup>/min
- Dry air cleaner with star-pleated element
- Easy to service
- Robust housing

# Silencer air cleaners

**MANN+HUMMEL silencer air cleaners reduce background noise that, for example, enters the environment from an intake air cleaner on a reciprocating engine. They are especially suitable for applications which operate under adverse conditions.**

### ADVANTAGES

- Very good noise reduction
- Robust metal housing
- Easy application

# Two-way ventilation air cleaners

## Part numbers and specifications

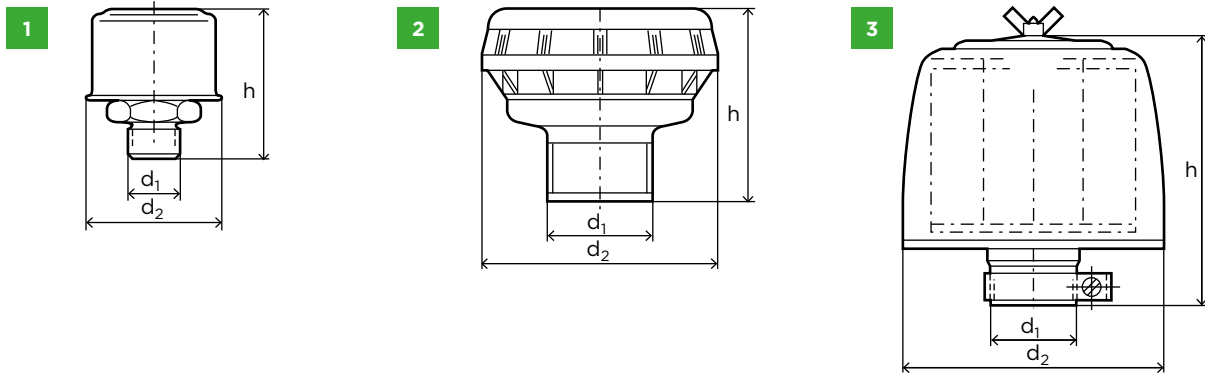

### PART NUMBERS AND DIMENSIONS

Part number	Application area		Figure	Opening pressure		Dimensions in mm (dimensions in inches)			Weight [kg]	Part number
	Nominal flow rate [m <sup>3</sup> /min]	at Δp [mbar]		[bar]	[kPa]	d <sub>1</sub>	d <sub>2</sub>	h		
45 001 62 185	-	8	1	-	-	M 18x1,5	45 (1.77)	47 (1.85)	0.08	- <sup>1)</sup>
45 003 65 900	-	10	2	-	-	35 (1.38)	80 (3.15)	65 (2.56)	0.06	- <sup>1)</sup>
45 003 62 902	-	10	2	-	-	G 3/4	80 (3.15)	73.5 (2.89)	0.08	- <sup>1)</sup>
45 003 62 901 <sup>2)</sup>	0.2	-	2	0.35	35	G 3/4	80 (3.15)	73.5 (2.89)	0.1	- <sup>1)</sup>
45 009 77 106	0.5	10	3	-	-	20 (0.79)	98 (3.86)	110 (4.33)	0.3	C 75/4
45 021 77 125	2.0	11	3	-	-	40 (1.57)	132 (5.20)	120 (4.72)	0.5	C 1112
45 032 77 105	3.5	10	3	-	-	52 (2.05)	132 (5.20)	152 (5.98)	0.65	C 1132
45 037 77 015	4.5	13	3	-	-	60 (2.36)	170 (6.69)	175 (6.89)	1.1	C 1337
45 074 77 115	8.0	10	3	-	-	80 (3.15)	208 (8.19)	185 (7.28)	1.3	C 1574
45 138 77 126	15.0	11	3	-	-	100 (3.94)	283 (11.14)	200 (7.87)	7.0	C 21 138/1

1) The entire air cleaner is exchanged during a service.

2) With integrated pressure control valve.

# Silencer air cleaners

## Part numbers and specifications

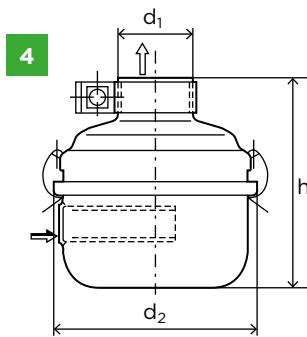

Clamp connection

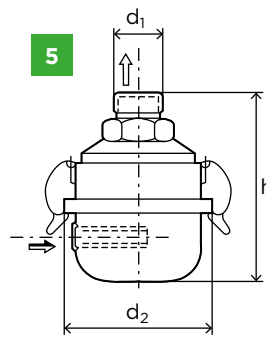

Threaded connection

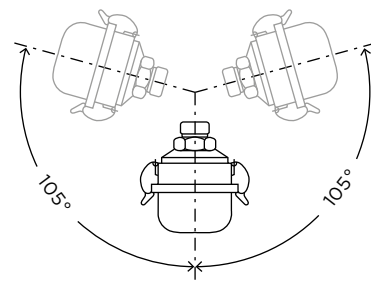

Range of possible installation angles

### PART NUMBERS AND DIMENSIONS

Part number	Application area		Figure	Silencer pipe	Dimensions in mm ( <i>dimensions in inches</i> )			Weight [kg]
	Nominal flow rate [m <sup>3</sup> /min]	at Δp [mbar]			d <sub>1</sub>	d <sub>2</sub>	h	
<b>41 007 87 113</b>	0.8	33	4	with	30 (1.18)	82 (3.23)	85 (3.35)	0.2
<b>41 015 87 113</b>	2.0	100	4	with	40 (1.57)	118 (4.65)	120 (4.72)	0.5
<b>41 021 87 013</b>	2.2	96	4	with	52 (2.05)	138 (5.43)	130 (5.12)	0.5
<b>41 004 82 123</b>	0.33	97	5	without	M 22x1.5	66 (2.60)	74 (2.91)	0.2
<b>41 004 82 183</b>	0.33	97	5	with	G 1/2	66 (2.60)	84 (3.31)	0.2



# Air cleaners

# Accessories

**In addition to our extensive range of air cleaners, we offer accessories which are designed to match our products. Their reliability and long life has been proven under extreme operating conditions in numerous applications. MANN+HUMMEL accessories are delivered with the same well-known OE-matching quality as our air cleaners.**

**Rain caps – Page 134**

For protection against ingress of water and coarse dirt particles

**Pre-separator dust bowls – Page 136**

For lengthening the service life of single-stage air cleaners

**Air connecting parts – Page 138**

For the secure connection of the air cleaner to the engine or compressor

**Service switches / indicators – Page 146**

For the electrical display of time to service

**Service display – Page 149**

For the optical display of time to service

# Air cleaner accessories

## Rain caps – Design A



### ADVANTAGES

- Protection against penetration of moisture into the air cleaner through rain, snow, spray water, etc.
- Protection against coarse contaminants
- Preservation of the main element
- Lengthening of the service interval
- Plastic version, Cr(VI)-free

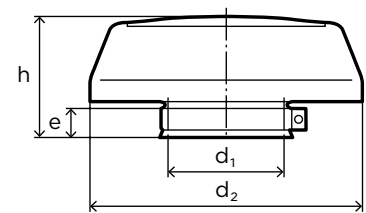

e = insertion depth

Part number	Suitable for				Dimensions in mm (dimensions in inches)				Weight [kg]
	Europiclon	NLG	Piclon	ENTARON XD	d <sub>1</sub>	d <sub>2</sub>	e	h	
<b>39 014 67 910</b>	45 050 ...	-	45 043 ...	-	42 (1.65)	150 (5.91)	22 (0.87)	63 (2.48)	0.11
<b>39 020 67 910</b>	45 100 ...	-	45 076 ...	-	54 (2.13)	150 (5.91)	22 (0.87)	63 (2.48)	0.11
<b>39 028 67 910</b>	45 200 ...	-	45 114 ...	-	62 (2.44)	150 (5.91)	22 (0.87)	63 (2.48)	0.11
<b>39 040 67 910</b>	45 300 ...	-	45 165 ...	-	68 (2.68)	200 (7.87)	30 (1.18)	85 (3.35)	0.23
<b>39 056 67 910</b>	45 400 ...	-	45 225 ...	-	82 (3.23)	200 (7.87)	30 (1.18)	85 (3.35)	0.23
<b>39 080 67 910</b>	45 500 ...	-	45 325 ...	-	102 (4.02)	270 (10.63)	40 (1.57)	115 (4.53)	0.44
<b>39 100 67 910</b>	45 600 ...	-	45 440 ...	-	110 (4.33)	270 (10.63)	40 (1.57)	115 (4.53)	0.44
<b>39 160 67 910</b>	-	NLG 15 - ...	45 650 ...	XD 14/17	132 (5.20)	360 (14.17)	50 (1.97)	150 (5.91)	0.90
<b>39 190 67 910</b>	-	NLG 21 - ...	45 880 ...	XD 21	150 (5.91)	360 (14.17)	50 (1.97)	150 (5.91)	0.90
<b>39 220 67 910</b>	-	NLG 28 - ...	-	XD 28	180 (7.09)	405 (15.94)	33 (1.30)	128 (5.04)	0.95
<b>39 370 67 910</b>	-	NLG 37 - ...	45 920 ...	XD 40	210 (8.27)	535 (21.06)	33 (1.30)	126 (4.96)	1.80

# Air cleaner accessories

## Rain caps – Design B



### ADVANTAGES

- Protection against penetration of moisture into the air cleaner through rain, snow, spray water, etc.
- Protection against coarse contaminants
- Preservation of the main element
- Lengthening of the service interval
- Plastic version, Cr(VI)-free

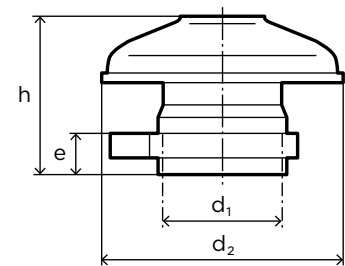

e = insertion depth

Part number	Suitable for				Dimensions in mm (dimensions in inches)				Weight [kg]
	Europiclon	NLG	Piclon	ENTARON XD	d <sub>1</sub>	d <sub>2</sub>	e	h	
<b>39 014 67 900</b>	45 050 ...	-	45 043 ...	-	42 (1.65)	92 (3.62)	22 (0.87)	53 (2.09)	0.07
<b>39 020 67 900</b>	45 100 ...	-	45 076 ...	-	54 (2.13)	110 (4.33)	22 (0.87)	53 (2.09)	0.08
<b>39 028 67 900</b>	45 200 ...	-	45 114 ...	-	62 (2.44)	124 (4.88)	22 (0.87)	56 (2.20)	0.11
<b>39 040 67 900</b>	45 300 ...	-	45 165 ...	-	68 (2.68)	145 (5.71)	22 (0.87)	63 (2.48)	0.12
<b>39 056 67 900</b>	45 400 ...	-	45 225 ...	-	82 (3.23)	172 (6.77)	22 (0.87)	64 (2.52)	0.15
<b>39 080 67 900</b>	45 500 ...	-	45 325 ...	-	102 (4.02)	203 (7.99)	35 (1.38)	90 (3.54)	0.18



### INSTALLATION NOTE

The rain caps are simply pushed onto the raw air inlet of the air cleaner or intake position of the raw air pipe and fixed using the supplied hose clamp.

# Air cleaner accessories

## Pre-separator

### Dust bowls



#### ADVANTAGES

- Lengthening of service life for single-stage air cleaners
- Protection against ingress of spray water and rain
- Easy reading of the filling level and therefore perfect determination of the time to service the cyclone through transparent insert
- Easy and uncomplicated emptying of the cyclone through clamp

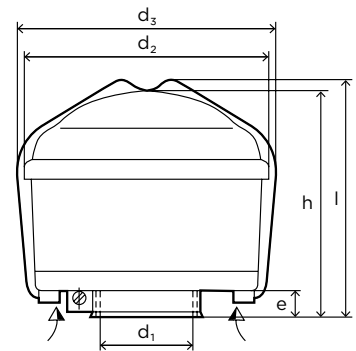

Vertical installation

Part number	Application area		Dimensions in mm (dimensions in inches)						Weight [kg]
	Nominal flow rate [m <sup>3</sup> /min]	at $\Delta p^{1)}$ [mbar]	d <sub>1</sub>	d <sub>2</sub>	d <sub>3</sub>	e <sup>2)</sup>	h	l	
<b>48 017 67 900</b>	1.4 - 1.7	7 - 10.5	42.2 (1.66)	164 (6.46)	175 (6.89)	52 (2.05)	140 (5.51)	150 (5.91)	0.4
<b>48 024 67 900</b>	2 - 2.4	8.5 - 12	54.2 (2.13)	164 (6.46)	175 (6.89)	52 (2.05)	140 (5.51)	150 (5.91)	0.4
<b>48 030 67 900</b>	2.8 - 3.4	9 - 13	62.2 (2.45)	164 (6.46)	175 (6.89)	52 (2.05)	140 (5.51)	150 (5.91)	0.4
<b>48 034 67 900</b>	2.8 - 3.4	6 - 9	62.2 (2.45)	219 (8.62)	236 (9.29)	62 (2.44)	167 (6.57)	180 (7.09)	1.0
<b>48 048 67 900</b>	4 - 4.5	10 - 12.5	68.2 (2.69)	219 (8.62)	236 (9.29)	62 (2.44)	167 (6.57)	180 (7.09)	1.0
<b>48 056 67 900</b>	5.6 - 6.8	12 - 17.5	82.2 (3.24)	219 (8.62)	236 (9.29)	62 (2.44)	167 (6.57)	180 (7.09)	1.0
<b>48 068 67 900</b>	5.6 - 6.8	7 - 10.5	82.2 (3.24)	303 (11.93)	315 (12.40)	84 (3.31)	208 (8.19)	217 (8.54)	1.3
<b>48 096 67 900</b>	8 - 9.6	8.5 - 12	102.2 (4.02)	303 (11.93)	315 (12.40)	84 (3.31)	208 (8.19)	217 (8.54)	1.3
<b>48 120 67 900</b>	10 - 12	11 - 16	110.2 (4.34)	303 (11.93)	315 (12.40)	84 (3.31)	208 (8.19)	217 (8.54)	1.3

1)  $\Delta p$  = Flow resistance. When used as a pre-separator, add 70 percent of the stated flow resistance to the resistance of the filter located downstream.

2) e = insertion depth





# Air cleaner accessories

## Air connecting parts

### 90 DEGREE ELBOWS



Part number	Figure	Dimensions in mm (dimensions in inches)					Connection for
		b	c	d <sub>i</sub>	d <sub>a</sub>	e	
39 100 25 999	1	-	-	-	-	-	-
39 100 25 979	2	57 (2.24)	33 (1.30)	50 (1.97)	55 (2.17)	25 (0.98)	M 10x1
39 200 25 999	1	-	-	-	-	-	-
39 200 25 979	2	62 (2.44)	38 (1.50)	60 (2.36)	65 (2.56)	25 (0.98)	M 10x1
39 300 25 999	1	-	-	-	-	-	-
39 300 25 979	2	72 (2.83)	43 (1.69)	70 (2.76)	75 (2.95)	29 (1.14)	M 10x1
39 400 25 999	1	-	-	-	-	-	-
39 400 25 979	2	77 (3.03)	48 (1.89)	80 (3.15)	85 (3.35)	30 (1.18)	M 10x1
39 215 25 999	1	-	-	-	-	-	-
39 215 25 979	2	77 (3.03)	-	89 (3.5)	94 (3.7)	25 (0.99)	-
39 500 25 999	1	-	-	-	-	-	-
39 500 25 979	2	92 (3.62)	58 (2.28)	100 (3.94)	105 (4.13)	35 (1.38)	M 10x1
39 600 25 999	1	-	-	-	-	-	-
39 600 25 979	2	89 (3.50)	64 (2.52)	110 (4.33)	115 (4.53)	27 (1.06)	M 10x1
39 700 25 999	1	-	-	-	-	-	-
39 700 25 979	2	98.5 (3.88)	74 (2.91)	130 (5.12)	135 (5.32)	27 (1.06)	M 10x1
39 800 25 999	1	-	-	-	-	-	-
39 800 25 979	2	108.5 (4.27)	83 (3.27)	150 (5.91)	155 (6.10)	27 (1.06)	M 10x1
39 930 25 999	1	-	-	-	-	-	-
39 930 25 979	2	170 (6.69)	98.5 (3.88)	180 (7.08)	196 (7.71)	30 (1.18)	M 10x1

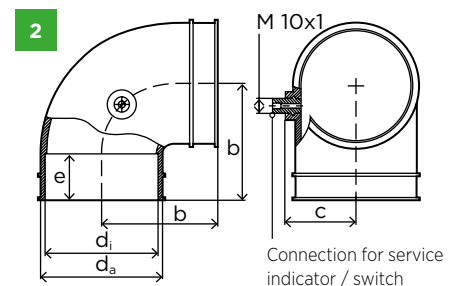
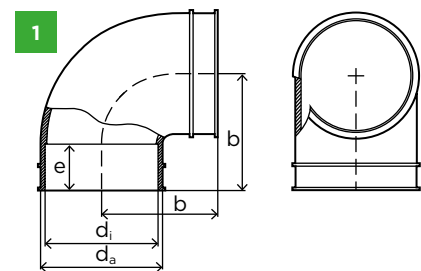

OPERATING  
TEMPERATURE  
-40 °C to +100 °C



# Air cleaner accessories

## Air connecting parts

### REDUCER CONNECTIONS

Part number	Dimensions in mm (dimensions in inches)				
	c	d <sub>1</sub>	d <sub>2</sub>	e	l
39 300 27 949	43 (1.69)	70 (2.76)	80 (3.15)	13.5 (0.53)	89.5 (3.52)
39 300 27 959	43 (1.69)	60 (2.36)	70 (2.76)	13.5 (0.53)	85.5 (3.37)

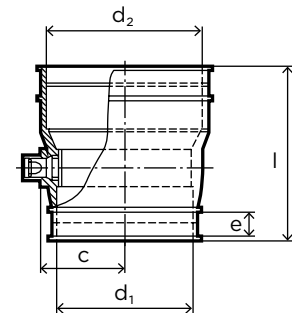

**OPERATING TEMPERATURE**  
-40 °C to +100 °C



### STRAIGHT CONNECTIONS

Part number	Figure	Dimensions in mm (dimensions in inches)					Connection for
		c	d <sub>1</sub>	d <sub>a</sub>	e	l	
39 100 27 999	1	-	50 (1.97)	55 (2.17)	25 (0.98)	68 (2.68)	-
39 100 27 979	2	33 (1.30)	50 (1.97)	55 (2.17)	25 (0.98)	68 (2.68)	M 10x1
39 200 27 999	1	-	60 (2.36)	65 (2.56)	25 (0.98)	68 (2.68)	-
39 200 27 979	2	38 (1.50)	60 (2.36)	65 (2.56)	25 (0.98)	68 (2.68)	M 10x1
39 300 27 999	1	-	70 (2.76)	75 (2.95)	28 (1.10)	75 (2.95)	-
39 300 27 979	2	43 (1.69)	70 (2.76)	75 (2.95)	28 (1.10)	75 (2.95)	M 10x1
39 400 27 999	1	-	80 (3.15)	85 (3.35)	30 (1.18)	78 (3.07)	-
39 400 27 979	2	48 (1.89)	80 (3.15)	85 (3.35)	30 (1.18)	78 (3.07)	M 10x1
39 215 27 999	1	-	89 (3.5)	94 (3.7)	25 (0.98)	70 (2.76)	-
39 500 27 999	1	-	100 (3.94)	105 (4.13)	35 (1.38)	88 (3.46)	-
39 500 27 979	2	58 (2.28)	100 (3.94)	105 (4.13)	35 (1.38)	88 (3.46)	M 10x1
39 600 27 999	1	-	110 (4.33)	115 (4.53)	27 (1.06)	72 (2.83)	-
39 600 27 979	2	63 (2.48)	110 (4.33)	115 (4.53)	27 (1.06)	72 (2.83)	M 10x1
39 700 27 999	1	-	130 (5.12)	135 (5.32)	27 (1.06)	72 (2.83)	-
39 700 27 979	2	73 (2.87)	130 (5.12)	135 (5.32)	27 (1.06)	72 (2.83)	M 10x1
39 800 27 999	1	-	150 (5.91)	155 (6.10)	27 (1.06)	72 (2.83)	-
39 800 27 979	2	83 (3.28)	150 (5.91)	155 (6.10)	27 (1.06)	72 (2.83)	M 10x1
39 930 27 999	1	-	180 (7.09)	195 (7.68)	45 (1.77)	140 (5.51)	-
39 930 27 979	2	109.5 (4.31)	180 (7.09)	195 (7.68)	45 (1.77)	140 (5.51)	M 10x1

1

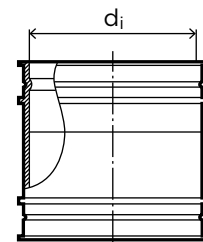

2

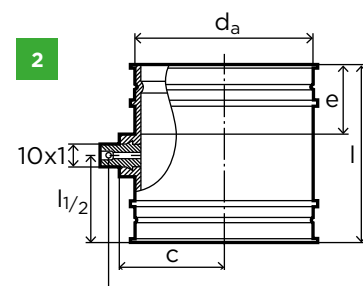

Connection for service indicator / switch

**OPERATING TEMPERATURE**  
-40 °C to +100 °C



# Air cleaner accessories

## Air connecting parts

### ACCORDION HOSES WITH MOLDED-ON END SLEEVES (STANDARD VERSION)

Part number	Dimensions in mm (dimensions in inches)				
	$d_i$	$d_a$	$e$	$l_{min}$	$l_{max}$
39 000 27 161	50 (1.97)	56 (2.20)	32±2 (1.26±0.08)	190 (7.48)	285 (11.22)
39 000 27 140	60 (2.36)	66 (2.60)	30±2 (1.18±0.08)	190 (7.48)	285 (11.22)
39 000 27 139	70 (2.76)	76 (2.99)	32±2 (1.26±0.08)	195 (7.68)	310 (12.20)
39 000 27 138	80 (3.15)	90 (3.54)	30±2 (1.18±0.08)	205 (8.07)	340 (13.39)
39 000 27 158	100 (3.94)	106 (4.17)	30±2 (1.18±0.08)	230 (9.06)	395 (15.55)
39 000 27 152	110 (4.33)	115 (4.53)	38±2 (1.50±0.08)	240 (9.45)	425 (16.73)
39 000 27 151	130 (5.12)	136 (5.35)	45+5 (1.77+0.20)	280 (11.02)	500 (19.69)
39 000 27 150	150 (5.91)	156 (6.14)	45+5 (1.77+0.20)	300 (11.81)	545 (21.46)

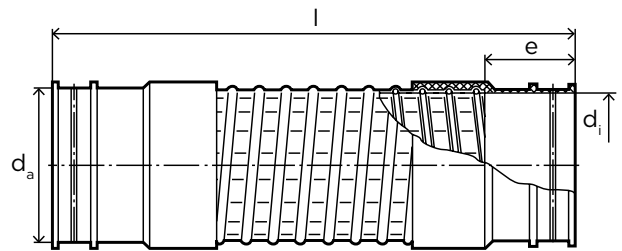

**MATERIAL**  
TPO



**MAXIMUM CURVATURE**  
90 degree (depending on  
the vibration load)

**OPERATING  
TEMPERATURE**  
-30 °C to +100 °C

### ACCORDION HOSES (REINFORCED MODEL)

Part number	Dimensions in mm (dimensions in inches)			
	$d_i$	$d_a$	$e$	$l$
39 000 27 206	60 (2.36)	68 (2.68)	50 (1.97)	215±5 (8.46±0.20)
39 000 27 207	70 (2.76)	78 (3.07)	50 (1.97)	215±5 (8.46±0.20)
39 000 27 208	80 (3.15)	88 (3.46)	50 (1.97)	215±5 (8.46±0.20)
39 000 27 213	100 (3.94)	108 (4.25)	50 (1.97)	215±5 (8.46±0.20)
39 000 27 214	110 (4.33)	118 (4.65)	50 (1.97)	215±5 (8.46±0.20)
39 000 27 215	130 (5.12)	138 (5.43)	50 (1.97)	215±5 (8.46±0.20)
39 000 27 184	150 (5.91)	158 (6.22)	50 (1.97)	215±5 (8.46±0.20)
39 000 27 346	200 (7.87)	208 (8.19)	50 (1.97)	215±5 (8.46±0.20)

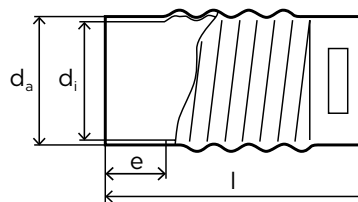

**MATERIAL**  
rubber with fabric insert

**MAXIMUM CURVATURE**  
45 degree (depending on  
the vibration load)



**OPERATING  
TEMPERATURE**  
-30 °C to +100 °C

# Air cleaner accessories

## Air connecting parts

### STRAIGHT COUPLINGS IN RUBBER



Part number	Dimensions in mm <i>(dimensions in inches)</i>		
	$d_i$	$d_a$	$l$
<b>39 000 27 198</b>	60 (2.36)	70 (2.76)	150 (5.91)
<b>39 000 27 197</b>	70 (2.76)	80 (3.15)	150 (5.91)
<b>39 000 27 252</b>	70 (2.76)	80 (3.15)	80 (3.15)
<b>39 000 27 196</b>	80 (3.15)	92 (3.62)	150 (5.91)
<b>39 000 27 195</b>	90 (3.54)	102 (4.02)	150 (5.91)
<b>39 000 27 104</b>	100 (3.94)	112 (4.41)	100 (3.94)
<b>39 000 27 194</b>	100 (3.94)	112 (4.41)	150 (5.91)
<b>39 000 27 193</b>	110 (4.33)	122 (4.80)	150 (5.91)
<b>39 000 27 359</b>	110 (4.33)	122 (4.80)	75 (2.95)
<b>39 000 27 188</b>	130 (5.12)	142 (5.59)	100 (3.94)
<b>39 000 27 192</b>	130 (5.12)	142 (5.59)	150 (5.91)
<b>39 000 27 183</b>	150 (5.91)	162 (6.38)	150 (5.91)
<b>39 223 27 111</b>	150 (5.91)	162 (6.38)	100 (3.94)
<b>39 000 27 182</b>	180 (7.09)	192 (7.56)	150 (5.91)
<b>39 000 27 345</b>	200 (7.87)	212 (8.35)	200 (7.87)
<b>39 000 27 306</b>	210 (8.27)	222 (8.74)	200 (7.87)

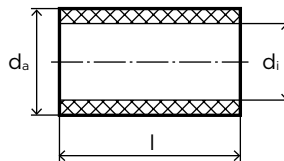

**MATERIAL**  
Rubber (NBR, 60±5 Shore)  
with fabric insert



**OPERATING TEMPERATURE**  
-30 °C to +100 °C

# Air cleaner accessories

## Air connecting parts

### 90 DEGREE ELBOWS IN RUBBER WITH FABRIC INSERT

Part number	Figure	Dimensions in mm (dimensions in inches)			
		b	d <sub>i</sub>	d <sub>a</sub>	r
39 000 25 280	1	115 (4.53)	52 (2.05)	60 (2.36)	76 (2.99)
39 000 25 264	1	115 (4.53)	60 (2.36)	68 (2.68)	76 (2.99)
39 000 25 263	1	140 (5.51)	70 (2.76)	79 (3.11)	92 (3.62)
39 000 25 262	1	140 (5.51)	80 (3.15)	90 (3.54)	95 (3.74)
39 000 25 258	2	205 (8.07)	100 (3.94)	110 (4.33)	155 (6.10)
39 000 25 265	2	215 (8.46)	110 (4.33)	120 (4.72)	165 (6.50)
39 000 25 266	2	265 (10.43)	130 (5.12)	140 (5.51)	210 (8.27)
39 000 25 267	2	300 (11.81)	150 (5.91)	160 (6.30)	245 (9.65)
39 000 25 270	2	355 (13.98)	200 (7.87)	210 (8.27)	300 (11.81)

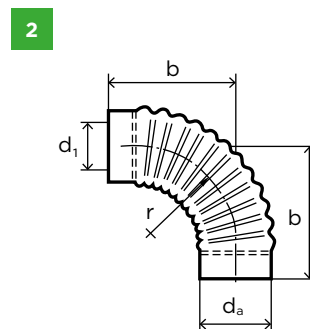
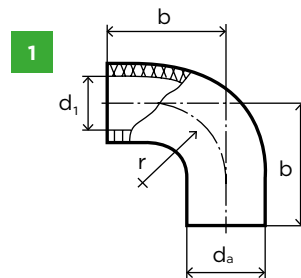

#### MATERIAL

Rubber (NBR, 60±5 Shore)  
with fabric insert



#### OPERATING TEMPERATURE

-25 °C to +100 °C

### COUPLINGS IN METAL

Part number	Dimensions in mm (dimensions in inches)		
	d <sub>a</sub>	l	s
39 000 25 167	62 (2.44)	65 (2.56)	1.0 (0.04)
39 000 25 168	82 (3.23)	50 (1.97)	1.0 (0.04)
39 000 25 165	92 (3.62)	50 (1.97)	1.0 (0.04)
39 000 25 175	102 (4.02)	50 (1.97)	1.0 (0.04)
39 000 25 176	110 (4.33)	50 (1.97)	1.0 (0.04)
39 000 25 184	150 (5.91)	90 (3.54)	1.0 (0.04)
39 000 25 185	180 (7.09)	90 (3.54)	1.0 (0.04)

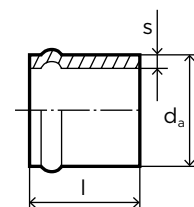

#### MATERIAL

Black painted metal

# Air cleaner accessories

## Air connecting parts

### CONNECTION PIPES IN METAL

**INTERMEDIATE PIPE**, only for raw air intake

Part number	Dimensions in mm (dimensions in inches)			
	$d_i$	$d_a$	$e$	$l$
<b>31 056 25 821</b>	82.2 (3.24)	82 (3.23)	80 (3.15)	245 (9.65)
<b>31 080 25 731</b>	102.2 (4.02)	102 (4.02)	80 (3.15)	250 (9.84)
<b>31 160 25 771</b>	132.2 (5.20)	132 (5.20)	110 (4.33)	400 (15.75)



**MATERIAL**  
Black painted metal

### PIPE

Part number	Dimensions in mm (dimensions in inches)		
	$d_a$	$l$	$s$
<b>39 000 25 173</b>	82 (3.23)	500 (19.69)	0.75 (0.03)
<b>39 000 25 183</b>	102 (4.02)	500 (19.69)	0.75 (0.03)
<b>39 000 25 166</b>	110 (4.33)	500 (19.69)	0.75 (0.03)
<b>39 000 25 155</b>	150 (5.91)	500 (19.69)	0.75 (0.03)



**MATERIAL**  
Black painted metal

# Air cleaner accessories

## Air connecting parts

### METAL ELBOWS

Part number	Figure	Dimensions in mm (dimensions in inches)				
		a	b	d <sub>a</sub>	r	s
39 000 25 188	1	60 (2.36)	60 (2.36)	52 (2.05)	41 (1.61)	0.75 (0.03)
31 034 25 442	1	95 (3.74)	95 (3.74)	62 (2.44)	60 (2.36)	0.75 (0.03)
39 000 25 207	2	100 (3.94)	100 (3.94)	70 (2.76)	62 (2.44)	1.0 (0.04)
39 000 25 956	2	110 (4.33)	110 (4.33)	80 (3.15)	56 (2.20)	1.0 (0.04)
39 000 25 148	1	61 (2.40)	61 (2.40)	82 (3.23)	56 (2.20)	1.0 (0.04)
39 000 25 153	1	80 (3.15)	67 (2.64)	90 (3.54)	60 (2.36)	1.0 (0.04)
39 000 25 124	2	110 (4.33)	110 (4.33)	100 (3.94)	65 (2.56)	1.0 (0.04)
39 000 25 192	2	110 (4.33)	110 (4.33)	110 (4.33)	85 (3.35)	1.0 (0.04)
39 000 25 198	2	125 (4.92)	125 (4.92)	110 (4.33)	85 (3.35)	1.0 (0.04)
39 000 25 147	1	120 (4.72)	120 (4.72)	130 (5.12)	95 (3.74)	1.0 (0.04)
39 000 25 224	2	140 (5.51)	140 (5.51)	130 (5.12)	95 (3.74)	1.0 (0.04)
39 000 25 333	2	180 (7.09)	180 (7.09)	150 (5.91)	110 (4.33)	1.0 (0.04)

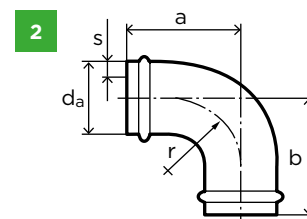
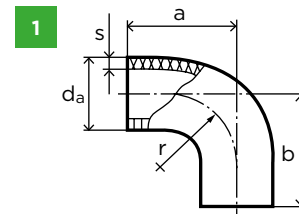

**MATERIAL**  
Black painted metal





# Air cleaner accessories

## Service switches

### ELECTRICAL MONITORING OF THE LEVEL OF ACCUMULATED DIRT



#### ADVANTAGES

- Continuous monitoring
- Insensitive to dust and moisture
- Reduction of potential damage with non-essential maintenance
- No readjustment of the switching point necessary
- Switch accuracy independent of component tolerances

#### SPECIFICATIONS

- Electronic signal when admitted differential pressure has been reached (clean air outlet to environment)
- Electronic signal processing possible
- Enclosed contact insert
- Pressure-dependent (not mechanical)
- Snap element (core element)
- Spring contacts not affected to contact erosion
- Material: PA6-GF30
- Switching pressure (negative pressure): 35 mbar to 80 mbar (3.5 kPa to 8.0 kPa)
- Max. switching capacity: 6W/24V DC (ohmic load,  $U_{max} = 24\text{ V}$ ,  $I_{max} = 0.25\text{ A}$ )
- Different connection threads and connector versions available

### ACCESSORIES FOR EXTERNAL MOUNTING - INSTALLATION EXAMPLES

#### Connection on air cleaner

(usually available)

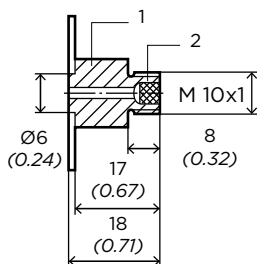

#### For retrofitting to the clean air pipe

1 Connection nipple  
Part no.: 21 010 15 121  
2 Felt disc  
Part no.: 23 005 31 171

Ensure that the felt disc is fitted to the nipple before installing.

#### Parts for hose connection

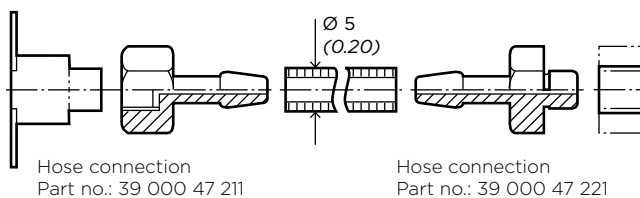

#### NOTE

The service switch should not be installed in a hanging position to prevent ingress of possible condensed water in the air pipe.



#### PERMISSIBLE OPERATING TEMPERATURE

-30 °C to +120 °C

# Air cleaner accessories

## Service switches

### SERVICE SWITCHES WITH CONNECTION FOR FLAT PLUG (PROTECTION CLASS: IP21)

Service switch internal thread M 10x1

Part number	switches at negative pressure	
	[mbar]	[kPa]
39 035 70 902	35±3	3.5±0.3
39 050 70 902	50±3	5.0±0.3
39 065 70 902	65±3	6.5±0.3
39 080 70 902	80±4	8.0±0.4

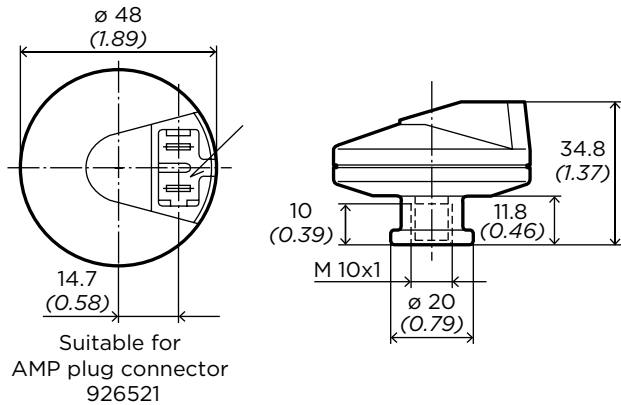

### SERVICE SWITCH FOR WATER-TIGHT ELECTRICAL CONNECTIONS (PROTECTION CLASS: IP65)

Service switch internal thread M 10x1

Part number	switches at negative pressure	
	[mbar]	[kPa]
39 035 70 702	35±3	3.5±0.3
39 050 70 702	50±3	5.0±0.3
39 065 70 702	65±3	6.5±0.3
39 080 70 702	80±4	8.0±0.4

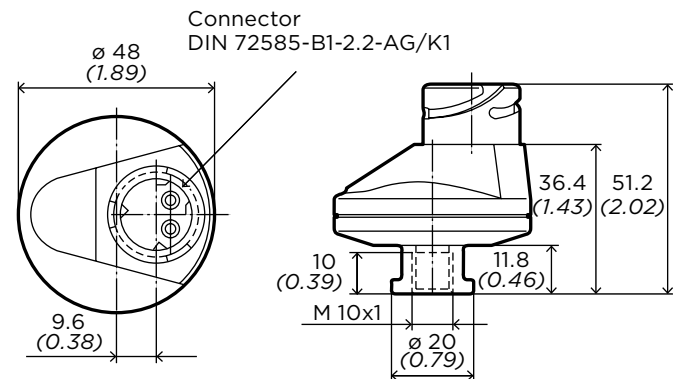

Service switch internal thread M 10x1

Part number	switches at negative pressure	
	[mbar]	[kPa]
39 035 70 802	35±3	3.5±0.3
39 050 70 802	50±3	5.0±0.3
39 065 70 802	65±3	6.5±0.3
39 080 70 802	80±4	8.0±0.4

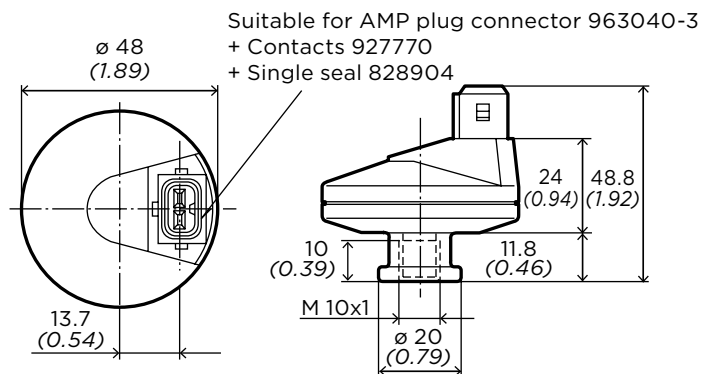

# Air cleaner accessories

## Electronic service indicator



Part number	Figure	Characteristics
39 000 70 920	1	Service indicator, packed, (Kit: display, sensor, cable harness, instructions), programmable for pressure increases 50/65/80 mbar
39 000 70 910	2	Pressure sensor packed with AMPSEAL 16 connector socket (readout of output voltage through additional control unit, e.g. application dashboard/onboard electronics)
26 013 98 100	3	Cable harness, packed, suitable for AMPSEAL 16 connector, with connection cable

<b>Measurement type</b>	Vacuum or pressure (reference to atmosphere)
<b>Operational pressure range</b>	0 - 100 mbar [0 - 10 kPa]
<b>Media</b>	Air
<b>Power supply</b>	Normal 5 - 30 V DC; sensor can be directly operated from vehicle with up to 30V DC
<b>Accuracy</b>	±2.5%
<b>Output voltage</b>	0.5 - 4.5 V DC
<b>Overvoltage protection</b>	45 V, forward voltage
<b>Reverse polarity protection</b>	36 V, misconnect 16 V
<b>Permissible operating temperature</b>	-40 °C to +125 °C
<b>Storage temperature</b>	-40 °C to +125 °C
<b>Vibration test parameter</b>	10 - 2,000 Hz bei 10 g
<b>Connection thread</b>	M 10x1, suitable for all MANN+HUMMEL air cleaners with connection possibility

### ADVANTAGES

- Display of continuous differential pressure increase during operation
- Enables scheduled filter servicing and reliability
- Reduction of operating costs, operating risks and downtimes

### SPECIFICATIONS

- Electrical display of time to service
- Suitable for differential pressure from 0 to 100 mbar
- Suitable for the air cleaner ranges: IQORON-series, ENTARON-series, Europiclön and NLG

#### 1 PROTECTION CLASS: IP50

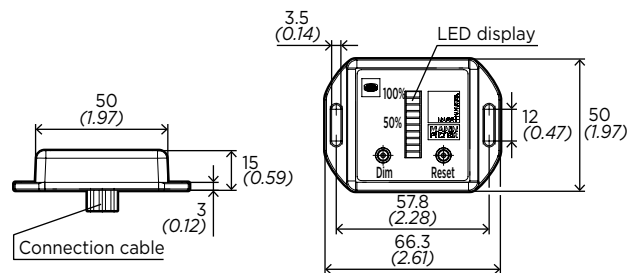

#### 2 PROTECTION CLASS: IP66

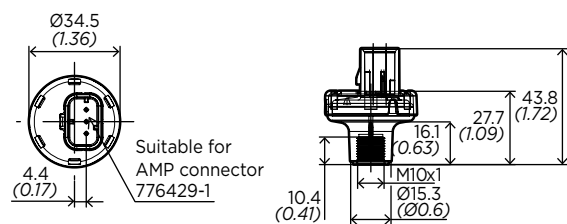

#### 3 PROTECTION CLASS: IP66

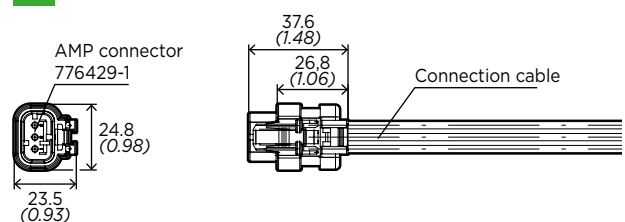

# Air cleaner accessories

## Service indicators

### OPTICAL SERVICE INDICATOR FOR THE CURRENT LEVEL OF DIRT ACCUMULATION



Part number	switches at negative pressure	
	[mbar]	[kPa]
39 035 70 911	35±3	3.5±0.3
39 050 70 911	50±4	5.0±0.4
39 050 70 931 <sup>1)</sup>	50±4	5.0±0.4
39 060 70 911	60±4	6.0±0.4
39 065 70 911	65±5	6.5±0.5
39 080 70 911	80±5	8.0±0.5

1) readable in vertical position

### ADVANTAGES

- Display when admitted differential pressure is reached (clean air outlet to environment) or of time to service the filter
- Indication also with motor switched off
- Insensitive to the pulsations of the intake air, therefore false indication is almost excluded

### FEATURES

- The yellow display piston snaps into 12 positions
- Triangular display field for remaining service life of the filter
- Filter service is due when the yellow piston reaches the red area
- Indicator can be reset after servicing by pressing a button

### SPECIFICATIONS

- Material: PC
- Switching pressure (negative pressure): 35 mbar to 80 mbar (3.5 kPa to 8 kPa)

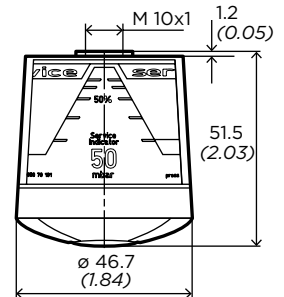

PERMISSIBLE OPERATING TEMPERATURE  
-30 °C to +100 °C



### SERVICE INDICATORS WITH 90 DEGREE FLANGE



Part number	switches at negative pressure	
	[mbar]	[kPa]
39 000 62 924	35±3	3.5±0.3
39 000 62 925	50±6	5.0±0.6
39 000 62 926	65±7	6.5±0.7
39 000 62 927	80±8	8.0±0.8

### ADVANTAGES

- Allows nearly all installation positions
- The red display indicating piston snaps into position when the maximum display value has been reached and signal the time to service the filter
- Resetting the display piston after maintenance is possible by pressing the button

### SPECIFICATIONS

- Material: PA
- Switching pressure (negative pressure): 35 mbar to 80 mbar (3.5 kPa to 8 kPa)

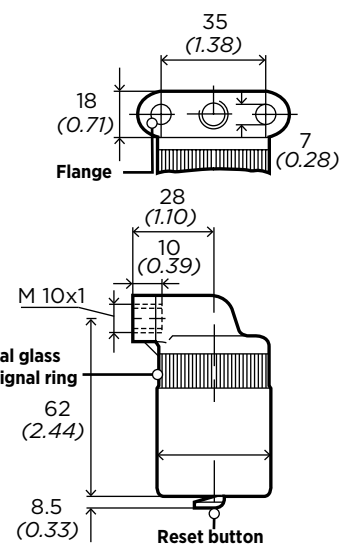

PERMISSIBLE OPERATING TEMPERATURE  
-40 °C to +100 °C



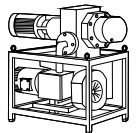
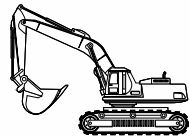
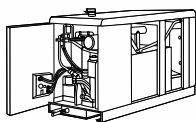
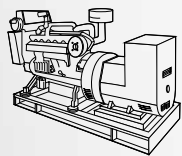

# Air cleaners

## Technical appendix

**Filter glossary – Page 152**

**Design criteria – Page 154**

**Determination of the dust capacity – Page 156**

**General instructions for installation and service – Page 158**

**Conversion table – Page 160**

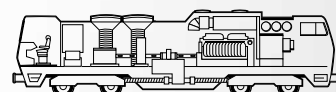
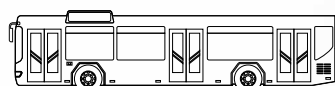
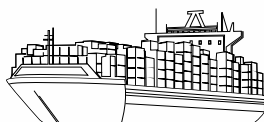

# MANN+HUMMEL

## Filter glossary

### **CLEAN AIR PIPE**

Pipe after air cleaner through which cleaned air is fed to the engine or compressor.

### **COMPACPLEAT**

Filter element for IQORON and IQORON-V air cleaners with large filter surface area for a long service life in a small installation space. This design provides a linear air flow through the air cleaner.

### **CYCLONE**

Centrifugal separator for the separation of particles from the intake air.

### **DUALSPIN**

A MANN+HUMMEL brand name for a pre-separator range for applications with high dust loads.

### **DUST DISCHARGE VALVE**

Valve on the housing of two-stage air cleaners which discharges the separated dust from the air cleaner housing.

### **ENTARON**

A MANN+HUMMEL brand name for a plastic air cleaner series with a conventional round design with tangential pre-separation. This series is available as a single-stage or two-stage air cleaner.

### **EUROPICLON**

MANN+HUMMEL brand name for a two-stage air cleaner range in plastic.

### **FLOW RESISTANCE $\Delta P$**

Measured in [mbar] or [kPa]. Measured variable for the pressure drop of a filter.

### **GLUE STRING TECHNOLOGY**

Standard technology for the ENTARON XD air cleaner range. The glue string stabilizes the pleat ends so that the filter element can achieve its full performance under all operating conditions.

### **IQORON**

MANN+HUMMEL brand name for an air cleaner series in plastic with multi-cyclone pre-separation.

### **INLINE CONCEPT**

Linear or axial air flow in the IQORON air cleaner series. In contrast to conventional round air cleaners, the air is not deflected by 90 degree from the raw air inlet to the clean air outlet.

### **LABORATORY DUST CAPACITY**

Measured in [g]. The measured quantity of a defined test dust which is added to a filter under laboratory conditions until the service point is reached.

### **LABORATORY SERVICE LIFE**

Measured in [h]. In accordance with the ISO standard, the time measured under laboratory conditions that an air cleaner with air flowing through it and loaded with dust will reach a defined flow resistance. The test dust, dust concentration and volume flow must be defined.

### **MAIN ELEMENT**

Also called the filter element or primary element. An air cleaner insert consisting of a filter media and gasket which effect the fine filtration in a dry air cleaner.

### **NLG**

MANN+HUMMEL brand name for an air cleaner series in plastic. This series is available as a single-stage or two-stage air cleaner.

### **NOMINAL FLOW RATE $\dot{V}$**

Measured in [ $\text{m}^3/\text{min}$ ]. Describes a design consideration for an air cleaner. Depending on the design or range the nominal flow rate describes the respective volume flow where the filter will show a pressure drop of 25 mbar to 30 mbar.

### **PICLON**

MANN+HUMMEL brand name for a two-stage air cleaner range in metal or in general for a two-stage version of a dry air cleaner (e.g. NLG Piclon).

### **PICO**

MANN+HUMMEL brand name for a single-stage air cleaner range in metal or in general for a single-stage version of a dry air cleaner (e.g. NLG Pico).

### **PICOLIGHT**

MANN+HUMMEL brand name for a single-stage air cleaner range without housing.

### **PICOLINO**

MANN+HUMMEL brand name for a single-stage air cleaner range in plastic for low volume flow rates.



# MANN+HUMMEL

## Filter glossary

### **PRE-SEPARATION EFFICIENCY**

Measured in [%]. Volume of dust separated in the first stage of a two-stage air cleaner. The pre-separation efficiency is a characteristic of two-stage air cleaners.

### **PULSATION**

Pressure oscillations in the intake channel of an engine or a compressor. This effect is exploited for dust discharge via a valve.

### **RAW AIR INTAKE**

Raw air pipe before the air cleaner through which ambient air is sucked in.

### **SCAVENGING**

Extends the service life of the air cleaner through continuous suction and extraction of the separated particles. The separated dust is actively removed from the pre-separator and deposits are avoided. In practice three types of scavenging have become established: using a blower (fan wheel from the engine cooling), exhaust ejector or ejector fitted downstream.

### **SECONDARY ELEMENT**

An additional air cleaner insert fitted downstream from the main element which prevents ingress of dust into the clean air pipe during maintenance or when the main element is defective.

### **SERVICE INDICATOR**

Mounted device which indicates the time when to service.

### **SERVICE LIFE**

Measured in [h]. The operating time of the filter element determined in the field before the air cleaner needs servicing.

### **SERVICE SWITCH**

Mounted device which triggers an electric signal when the time for a service is reached which in turn sets off an audio or visual warning signal.

### **SINGLE-STAGE AIR CLEANER**

Air cleaner without pre-separation. Available with and without secondary element. Advantageous for requirements with a low flow resistance.

### **TWO-STAGE AIR CLEANER**

An air cleaner with an integrated filtration stage for pre-separation of dust from the intake air.

### **VARIOPLEAT**

Innovative filter element concept with high power density for air cleaner systems with an axial air flow. The variable element geometry enables excellent exploitation of tight installation space.

# Air cleaners

## Design criteria

### SEPARATION EFFICIENCY

The most important task of an air cleaner is to provide adequate protection for the application in use (e.g. engine, compressor, etc.) under all conceivable operating conditions. The separation efficiency of the filter therefore has to be sufficiently high to meet this requirement.

The measurement of the separation efficiency is defined by ISO 5011. A dosing device is used to add dust to the filter with a defined particle size spectrum and concentration. The filter separates by far the largest part of this dust.

The separation efficiency of the filter is given by the ratio of the separated dust mass to the dosed dust mass. The separation efficiency of dry air cleaners is usually above 99.95 percent.

For two-stage cleaners where a filter acts as a pre-separator an additional pre-separation efficiency is given which is

determined in exactly the same way. A higher pre-separation efficiency correspondingly reduces the dust concentration which enters the main filter element and serves to extend the service life of the filter. Whereas, the total separation efficiency of the filter is determined by the filter element.

Only the comparison of two separation efficiencies shows the often significant differences in dust penetration.

#### EXAMPLE:

Filter 1: 99.93% separation efficiency

Filter 2: 99.97% separation efficiency

$(1-0.9993) / (1-0.9997) = 2.3$

Filter 1 with a separation efficiency of 99.93 percent has a higher dust penetration by a factor of 2.3 than filter 2 with a separation efficiency of 99.97 percent.

### SERVICE LIFE

In order to determine the service life of a filter, a defined amount of dust is added to the filter in the test laboratory until an agreed differential pressure or a differential pressure defined according to ISO is achieved over the complete filter. During the test the differential pressure increases constantly. The time from the start to the end of the test is described as the laboratory service life of the air cleaner and is given in hours.

The filter separation efficiency and the filter service life are characteristics of an air cleaner which can be verified at any time. In practice, the service life is usually longer due to the fact that the laboratory conditions are generally much more extreme than conditions in the field.

# Air cleaners

## Design criteria

### SPECIFICATION OF FILTER SIZE

#### Step 1: Determination of the pulsation factors

With a small number of cylinders, flow pulsations occur in the intake system. The corresponding varying velocities must be taken into account when determining the size of the filter. The use of so-called pulsation factors (Table 1) can be used to overcome this problem.

#### Step 2: Calculation of the design flow rate

With 1-4 cylinders, the air requirement obtained above must be multiplied by the corresponding pulsation factor to determine the filter size. This results in the following equation (1):

**Design flow rate = air requirement x pulsation factor with air requirement in [m<sup>3</sup>/min]**

For naturally aspirated engines with 5 or more cylinders, and for all turbocharged engines, the air requirement corresponds to the design flow rate of the filter, i.e., the filter size is specified directly with the determined design flow rate (m<sup>3</sup>/min).

**The design flow rate of the filter is a deciding factor for the air cleaner size. A filter must be chosen which has a nominal flow rate which is equal to or greater than the design air flow rate.**

### ESTIMATION OF THE DESIGN FLOW RATE BASED ON ENGINE OUTPUT

If the necessary data is not available for the previous calculation, the air requirement can be estimated using the following approximations:

#### Diesel engines

1 kW approx. 0.09 m<sup>3</sup>/min

#### Petrol engines

1 kW approx. 0.07 m<sup>3</sup>/min

#### Screw compressors

1 kW approx. 0.15 m<sup>3</sup>/min

#### Special applications (e.g. stationary petrol engines)

on request

**Table 1: Pulsation factors**

Number of cylinders	Pulsation factors for air intake			
	Naturally aspirated engines		Turbocharged <sup>1)</sup>	Piston compressors <sup>2)</sup>
	4-stroke engine	2-stroke engine		
<b>1</b>	2	1.5	1	1.5
<b>2</b>	1.4	1.2	1	1.2
<b>3</b>	1.3	1.1	1	1.1
<b>4</b>	1.1	1	1	1
<b>5 and more</b>	1	1	1	1

1) Turbocharged engines do not require a pulsation factor.

2) For compressors with gripper control a pulsation factor of 2 is valid.

**EXAMPLE 1:** 3-cylinder 4-stroke combustion engine with a volume flow rate of 1.6 m<sup>3</sup>/min.

#### 1. Pulsation factor from the table

Dry air cleaner, 3-cylinder, 4-stroke engine

**Pulsation factor = 1.3**

#### 2. Design flow rate acc. to equation (1)

**V = 1.6 m<sup>3</sup>/min x 1.3**

**V = 2.1 m<sup>3</sup>/min**

**Result:** The design flow rate of the engine is **2.1 m<sup>3</sup>/min**.

**EXAMPLE 2:** Turbocharged Diesel engine with 107 kW output power

**V = 107 x 0.09**

**V = 9.63 m<sup>3</sup>/min**

# Determination of the dust capacity

## Introduction

All MANN+HUMMEL air cleaners are tested on special test benches. The resulting data allows a uniform basis for comparison for the dust capacity of the various filter types and sizes. This offers true comparison possibilities for filters from different sources and enables a service life estimation for use in practice.

In this catalog the mean value curves of the effective dust-holding capacity for the described filters are illustrated based on the nominal volume flow rate ( $\dot{V}$ ). These values relate to a standard ISO coarse test dust with an exactly defined particle size distribution and were determined with a dust concentration of  $1 \text{ g/m}^3$ . Here one can speak of a so-called laboratory service life.

In order to calculate the values of these test benches to service lives or driving kilometers in practice, the dust concentration occurring there must be known.

Extensive tests have led to the overview on this page (Table 2):

**Table 2: Typical dust concentrations**

Mean dust concentration in	[mg/m <sup>3</sup> ]
Trucks in normal European road traffic	0.6
Trucks in road traffic outside Europe	3
Off-highway trucks (construction site use)	8
Construction machines (front-end loaders, track vehicles, mobile compressors)	35
Agricultural machines in central Europe (agriculture without periods of drought)	5
Agricultural machines in areas outside Europe in single operation	15
Agricultural machines used in fleets	50
Quick-moving track vehicles	100

### ESTIMATION OF CONDITIONS IN PRACTICE

Equation (2) is used in order to estimate the hours of operation in practice from the laboratory dust capacities.

Equation (2) indicates that the so-called service life of a filter directly depends on the laboratory dust capacity. In addition to the influencing factors described in equation (2) such as laboratory dust capacity, dust concentration and air requirement, in practice there are further parameters which cannot be taken into account here. This includes, for example, the distribution of particle sizes and different air humidity levels.

In practice, both influencing factors deviate from the standardized test conditions.

### Equation (2): Estimated hours of operation

**EXAMPLE 3:** A construction machine with an air requirement of  $12 \text{ m}^3/\text{min}$  is equipped with a filter with a laboratory dust capacity of  $5,800 \text{ g}$ . The expected hours of operation are to be calculated.

According to equation (2):

$$\text{Hours of operation} = \frac{5,800 \cdot 1,000}{35 \cdot 12 \cdot 60}$$

$$\text{Hours of operation} = 230 \text{ hours}$$

$$\text{Hours of operation} = \frac{\text{Laboratory dust capacity} \cdot 1,000}{\text{Dust concentration} \cdot \text{air requirement} \cdot 60}$$

Dust capacity in [g]

Dust concentration in [mg/m<sup>3</sup>]

Air requirement in [m<sup>3</sup>/min]

# Determination of the dust capacity

## Application example

### VEHICLE DATA

Vehicle type: tractor  
Location: Central Europe, designed for use in harvesting fleet

### ENGINE DATA

Fuel: diesel  
Type: aspirating engine  
Cylinders: 4  
Assumed air requirement: 5 m<sup>3</sup>/min

### REQUIREMENTS

Initial resistance: max. 25 mbar  
End resistance: max. 65 mbar  
Required service life: min. 150 operating hours

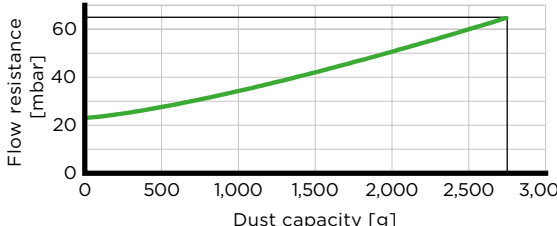
<p><b>STEP 1:</b> Determining the pulsation factors</p>	<p>From Table 1 we can see:</p>	<table border="1"> <thead> <tr> <th rowspan="2">No. of cylinders</th> <th colspan="4">Pulsation factors for air intake</th> </tr> <tr> <th>Aspirating engines 2-stroke engine</th> <th>4-stroke engine</th> <th>Turbo-charged</th> <th>Piston compressors</th> </tr> </thead> <tbody> <tr> <td>1</td> <td>2</td> <td>1.5</td> <td>1</td> <td>1.5</td> </tr> <tr> <td>2</td> <td>1.4</td> <td>1.2</td> <td>1</td> <td>1.2</td> </tr> <tr> <td>3</td> <td>1.3</td> <td>1.1</td> <td>1</td> <td>1.1</td> </tr> <tr> <td>4</td> <td>1.1</td> <td>1</td> <td>1</td> <td>1</td> </tr> <tr> <td>5 +</td> <td>1</td> <td>1</td> <td>1</td> <td>1</td> </tr> </tbody> </table>	No. of cylinders	Pulsation factors for air intake				Aspirating engines 2-stroke engine	4-stroke engine	Turbo-charged	Piston compressors	1	2	1.5	1	1.5	2	1.4	1.2	1	1.2	3	1.3	1.1	1	1.1	4	1.1	1	1	1	5 +	1	1	1	1
No. of cylinders	Pulsation factors for air intake																																			
	Aspirating engines 2-stroke engine	4-stroke engine	Turbo-charged	Piston compressors																																
1	2	1.5	1	1.5																																
2	1.4	1.2	1	1.2																																
3	1.3	1.1	1	1.1																																
4	1.1	1	1	1																																
5 +	1	1	1	1																																
<p><b>STEP 2:</b> Determining the design flow rate</p>	<p>Acc. to equation (1):</p>	<p><math>V = 5.0 \text{ m}^3/\text{min} \cdot 1.1</math> <math>V = 5.5 \text{ m}^3/\text{min}</math></p>																																		
<p><b>STEP 3:</b> Filter recommendation</p>	<p>Due to the operating conditions an <b>ENTARON HD 5.5</b> is, for example, recommended with a secondary element.</p>	<p><b>Part number: 45 151 92 910</b> In the resistance diagram on page 64 the initial pressure drop of the filter can be read to be 23.5 mbar.</p>																																		
<p><b>STEP 4:</b> Laboratory dust capacity from the diagram</p>	<p>The diagram on page 64 indicates a dust capacity of 2,750 g.</p>																																			
<p><b>STEP 5:</b> Dust concentration in practice</p>	<p>According to Table 2 "Dust concentrations",</p>	<p>there is a concentration of 50 mg/m<sup>3</sup> for fleet operations.</p>																																		
<p><b>STEP 6:</b> Calculation of hours of operation</p>	<p>According to equation (2):</p>	<p><math>\text{Hours of operation} = \frac{2,750 \cdot 1,000}{50 \cdot 5.5 \cdot 60}</math> <b>Hours of operation = 167 hours</b></p>																																		

# General instructions for installation and service

## AIR CLEANER INSTALLATION

There are a number of important points to be observed when installing dry air cleaners:

- The temperature stability of MANN+HUMMEL filter elements covers  $-40\text{ °C}$  to  $+80\text{ °C}$  in continuous operation with short peaks of up to  $+100\text{ °C}$  (e.g. due to heating up from the switched-off engine).
- The air cleaner should be fitted as close to the engine as possible and should be easily accessible for servicing.
- Enough room must be left for filter element removal.
- The air cleaner should be installed in such a way that the clean air pipes (the connection between air cleaner and engine) do not need to be removed under any circumstances during air cleaner or engine servicing.

- Service indicators should be clearly visible, and in some cases service switches are recommended with external service display.
- Avoid positioning the air cleaner in an area where water is splashed or a lot of dust is raised (e.g. in areas where the wheels spray).
- The air cleaner should be mounted on the vehicle frame or some sturdy body component. The original brackets are recommended for this purpose. If the air cleaner is subjected to heavy impacts, it should be installed on an elastic mounting.
- The air cleaner should be installed where it is protected against collision damage (observe the gradient of slope). This is especially valid for off road vehicles.

## AIR INTAKE

- The air intake should be located in a low-dust area. This generally means as high as possible and, for on-road vehicles, as far forward as possible (see Fig. 3).
- The air intake should not be placed in the skid area of wheels and under the vehicle floor. Screening against the ingress of water (e.g. gushing water, rain, or while the vehicle is being washed) is required. Rain caps are recommended.
- The intake of hot air (e.g. radiator cooling air) and exhaust gases should be avoided. Intake of exhaust soot drastically shortens the air cleaner service intervals.
- The intake openings should be as large as possible. Intake-flow velocities should not exceed  $3\text{ m/sec}$ .

## INTAKE AIR PIPES

- Only use suitable material for these pipes. This applies in particular to the clean air pipe. MANN+HUMMEL accessories fulfil these requirements.
- The line cross sections should not be selected smaller than the connection cross sections on the air cleaner.
- Due to mounting to different parts of the vehicle (engine, chassis, driver's cab), the connection pieces in the air intake system are subject to relative movement. This should be compensated by fitting flexible intermediate links between the air intake pipes. Spiral and rubber accordion hoses are recommended for this purpose. The pipes are not to be welded to the inlet and outlet connections on the air cleaner. Rubber hoses are also recommended for these connections.
- Pipes should be fitted to avoid damage from scuffing, melting of rubber hoses on hot exhaust components or damage through other causes, such as stones thrown up from vehicle wheels.
- When installing these dirty air pipes, care should be taken to ensure that water pockets cannot form. Drain points must be provided if necessary.

**Fig. 3: Dust concentration depending on the position of the air intake**

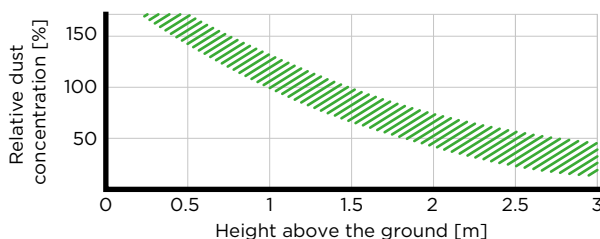

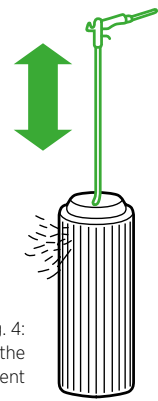

Fig. 4:  
Cleaning the  
main element

## CLEAN AIR PIPES

The clean air pipes must be airtight. Leaky clean air pipes allow dirt to bypass the filter and enter the engine, causing premature wear. The following points should be observed:

- The clean air pipes should be as short as possible and use the least number of joints.
- The material used for the pipes must retain its shape and remain airtight during operation (it is a vacuum system). This applies in particular to all flexible connections. Fabric-reinforced rubber hoses retain their shape well and are also sufficiently resistant to oil, fuel, ozone and weather and are adequately temperature-resistant.
- Hose clamps for securing the connecting elements must be sufficiently wide and strong, and must not cut into the hoses. In the closing area they should be designed so that no folding of the hose is possible.
- Pipes and couplings must not have any rough welding or casting seams, or overlapping metal. Connecting sleeves for mounting rubber hoses or elbows should be provided with a sealing bead. The length of overlap must be sufficient (at least 30 mm).
- Self-made clean air pipes should be descaled and varnished on the inside before being fitted.
- Clean air pipes must be regularly checked for leaks. Faulty connection components must be replaced.

## MAINTENANCE

An air cleaner service becomes necessary when the filter element is exhausted. The following basic principles should be observed:

- Always select the service point according to the service indicator or service switch. A regular inspection or cleaning of the element, as is sometimes practiced in the field, is more likely to be damaging than useful as there is a risk that the element will be damaged and that dust will gain access to the engine.
- **MANN+HUMMEL always recommends exchanging rather than cleaning the filter element in order to prevent damage and ensure maximum engine protection.**
- If, however, cleaning cannot be avoided, care should be taken that the filter element is not washed out.
- In order to clean, position a pipe with an end bent by approx. 90 degree on the end of a compressed-air pistol. The pipe must be long enough to reach to the bottom of the filter element. Carefully blow out the filter element with dry compressed air (max. 5 bar) from the inside to the outside, or from the clean air side to the raw air side until there is no more development of dust. The end of the pipe must not touch the element (see Fig. 4).
- The filter is then checked carefully for possible damage.
- Never beat or knock the filter element as this will damage it and there will be a danger of damage to the engine.
- Please note that the secondary element is never cleaned, but must be always replaced.
- Please note that a cleaned element will never match the service life and performance of a new element.
- After servicing the filter element carefully wipe out the inside of the housing and the seal contact surface with a moist cloth. Take care that no dust or dirt gains access to the clean air side of the air cleaner.
- When installing the filter element take care that it is correctly positioned in the housing so that the function of the gaskets is not impaired.
- Please note that engine damage can cause considerable costs and downtimes which can make the cost of a new filter element appear insignificant.
- There are detailed maintenance instructions available for the various filter ranges from MANN+HUMMEL which offer detailed instructions on the correct maintenance of your air cleaner. Please ask us – and we will be happy to answer your questions.

# MANN+HUMMEL

## Conversion table

### PRESSURE

5 mbar	=	0.5 kPa	=	2 " H <sub>2</sub> O
10 mbar	=	1.0 kPa	=	4 " H <sub>2</sub> O
15 mbar	=	1.5 kPa	=	6 " H <sub>2</sub> O
20 mbar	=	2.0 kPa	=	8 " H <sub>2</sub> O
25 mbar	=	2.5 kPa	=	10 " H <sub>2</sub> O
30 mbar	=	3.0 kPa	=	12 " H <sub>2</sub> O
35 mbar	=	3.5 kPa	=	14 " H <sub>2</sub> O
40 mbar	=	4.0 kPa	=	16 " H <sub>2</sub> O
45 mbar	=	4.5 kPa	=	18 " H <sub>2</sub> O
50 mbar	=	5.0 kPa	=	20 " H <sub>2</sub> O
55 mbar	=	5.5 kPa	=	22 " H <sub>2</sub> O
60 mbar	=	6.0 kPa	=	24 " H <sub>2</sub> O
62.5 mbar	=	6.3 kPa	=	25 " H <sub>2</sub> O
65 mbar	=	6.5 kPa	=	26 " H <sub>2</sub> O
70 mbar	=	7.0 kPa	=	28 " H <sub>2</sub> O
75 mbar	=	7.5 kPa	=	30 " H <sub>2</sub> O
80 mbar	=	8.0 kPa	=	32 " H <sub>2</sub> O

### WEIGHT

10 g	=		=	0.35 ounces	=	
25 g	=		=	0.88 ounces	=	
50 g	=		=	1.75 ounces	=	
100 g	=		=	3.5 ounces	=	
250 g	=		=	8.8 ounces	=	
500 g	=		=	17.6 ounces	=	
1,000 g	=	1 kg	=	35.3 ounces	=	2.2 lb
2,000 g	=	2 kg	=	70.5 ounces	=	4.4 lb
3,000 g	=	3 kg	=	105.8 ounces	=	6.6 lb
4,000 g	=	4 kg	=	141.1 ounces	=	8.8 lb
5,000 g	=	5 kg	=	176.4 ounces	=	11.03 lb
10,000 g	=	10 kg	=		=	22.05 lb
20,000 g	=	20 kg	=		=	44.1 lb
50,000 g	=	50 kg	=		=	110.23 lb

### TEMPERATURE

-30 °C	=	-22.0 °F
-10 °C	=	14.0 °F
0 °C	=	32.0 °F
10 °C	=	50.0 °F
30 °C	=	86.0 °F
50 °C	=	122.0 °F
80 °C	=	176.0 °F
100 °C	=	212.0 °F
120 °C	=	248.0 °F

### POWER

10 kW	=	13.4 HP
20 kW	=	26.8 HP
50 kW	=	67.1 HP
100 kW	=	134.1 HP
150 kW	=	201.2 HP
200 kW	=	268.2 HP
250 kW	=	335.3 HP
500 kW	=	670.5 HP
1,000 kW	=	1,341.0 HP

### VOLUME FLOW m<sup>3</sup>/min in cfm

1 m <sup>3</sup> /min	=	35.3 cfm
1.7 m <sup>3</sup> /min	=	60.0 cfm
2 m <sup>3</sup> /min	=	70.6 cfm
3 m <sup>3</sup> /min	=	105.9 cfm
4 m <sup>3</sup> /min	=	141.3 cfm
4.5 m <sup>3</sup> /min	=	158.9 cfm
6 m <sup>3</sup> /min	=	211.9 cfm
8 m <sup>3</sup> /min	=	282.5 cfm
10 m <sup>3</sup> /min	=	353.1 cfm
12 m <sup>3</sup> /min	=	423.8 cfm
15 m <sup>3</sup> /min	=	529.7 cfm
18 m <sup>3</sup> /min	=	635.7 cfm
20 m <sup>3</sup> /min	=	706.3 cfm
21 m <sup>3</sup> /min	=	741.6 cfm
24 m <sup>3</sup> /min	=	847.6 cfm
25 m <sup>3</sup> /min	=	882.9 cfm
28 m <sup>3</sup> /min	=	988.8 cfm
32 m <sup>3</sup> /min	=	1,130.1 cfm
37 m <sup>3</sup> /min	=	1,306.6 cfm
40 m <sup>3</sup> /min	=	1,412.6 cfm
42 m <sup>3</sup> /min	=	1,483.2 cfm
50 m <sup>3</sup> /min	=	1,765.7 cfm
60 m <sup>3</sup> /min	=	2,118.9 cfm
80 m <sup>3</sup> /min	=	2,825.2 cfm
100 m <sup>3</sup> /min	=	3,531.5 cfm

### VOLUME FLOW cfm in m<sup>3</sup>/min

25 cfm	=	0.7 m <sup>3</sup> /min
50 cfm	=	1.4 m <sup>3</sup> /min
75 cfm	=	2.1 m <sup>3</sup> /min
100 cfm	=	2.8 m <sup>3</sup> /min
150 cfm	=	4.2 m <sup>3</sup> /min
200 cfm	=	5.7 m <sup>3</sup> /min
250 cfm	=	7.1 m <sup>3</sup> /min
300 cfm	=	8.5 m <sup>3</sup> /min
350 cfm	=	9.9 m <sup>3</sup> /min
400 cfm	=	11.3 m <sup>3</sup> /min
450 cfm	=	12.7 m <sup>3</sup> /min
500 cfm	=	14.2 m <sup>3</sup> /min
550 cfm	=	15.6 m <sup>3</sup> /min
600 cfm	=	17.0 m <sup>3</sup> /min
650 cfm	=	18.4 m <sup>3</sup> /min
700 cfm	=	19.8 m <sup>3</sup> /min
750 cfm	=	21.2 m <sup>3</sup> /min
800 cfm	=	22.7 m <sup>3</sup> /min
850 cfm	=	24.1 m <sup>3</sup> /min
900 cfm	=	25.5 m <sup>3</sup> /min
950 cfm	=	26.9 m <sup>3</sup> /min
1,000 cfm	=	28.3 m <sup>3</sup> /min
1,500 cfm	=	42.5 m <sup>3</sup> /min
2,000 cfm	=	56.6 m <sup>3</sup> /min
3,000 cfm	=	85.0 m <sup>3</sup> /min





# MANN+HUMMEL

## Filtration worldwide



**A subsidiary or representative is also available in your region to ensure that you can reach us. If you have any questions or require further information, please contact your MANN+HUMMEL contact person or our headquarters.**

**MANN+HUMMEL GmbH**

Phone: +49 6232 53-80

Fax: +49 6232 53-88

Email: [oem@mann-hummel.com](mailto:oem@mann-hummel.com)

[www.oe-products.mann-hummel.com](http://www.oe-products.mann-hummel.com)

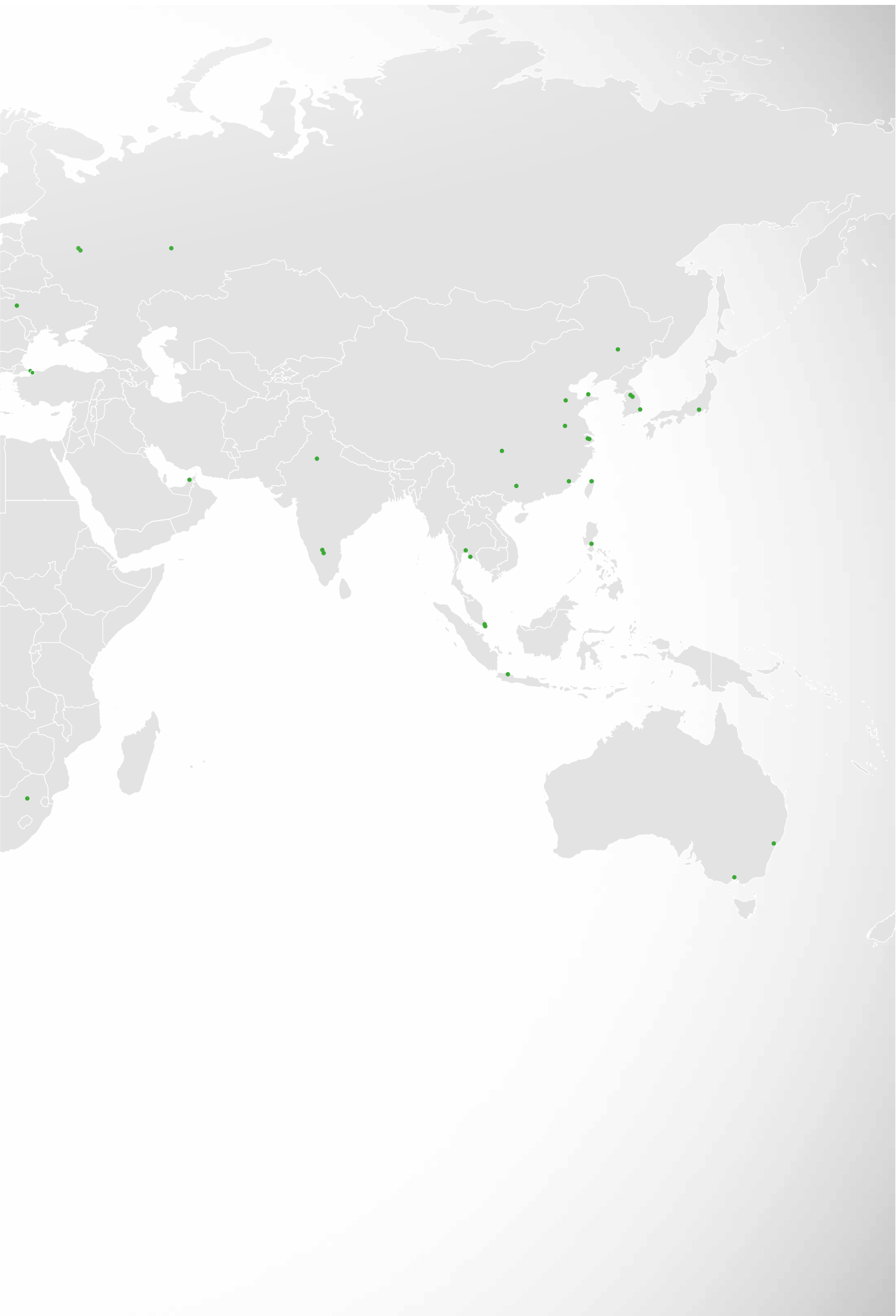

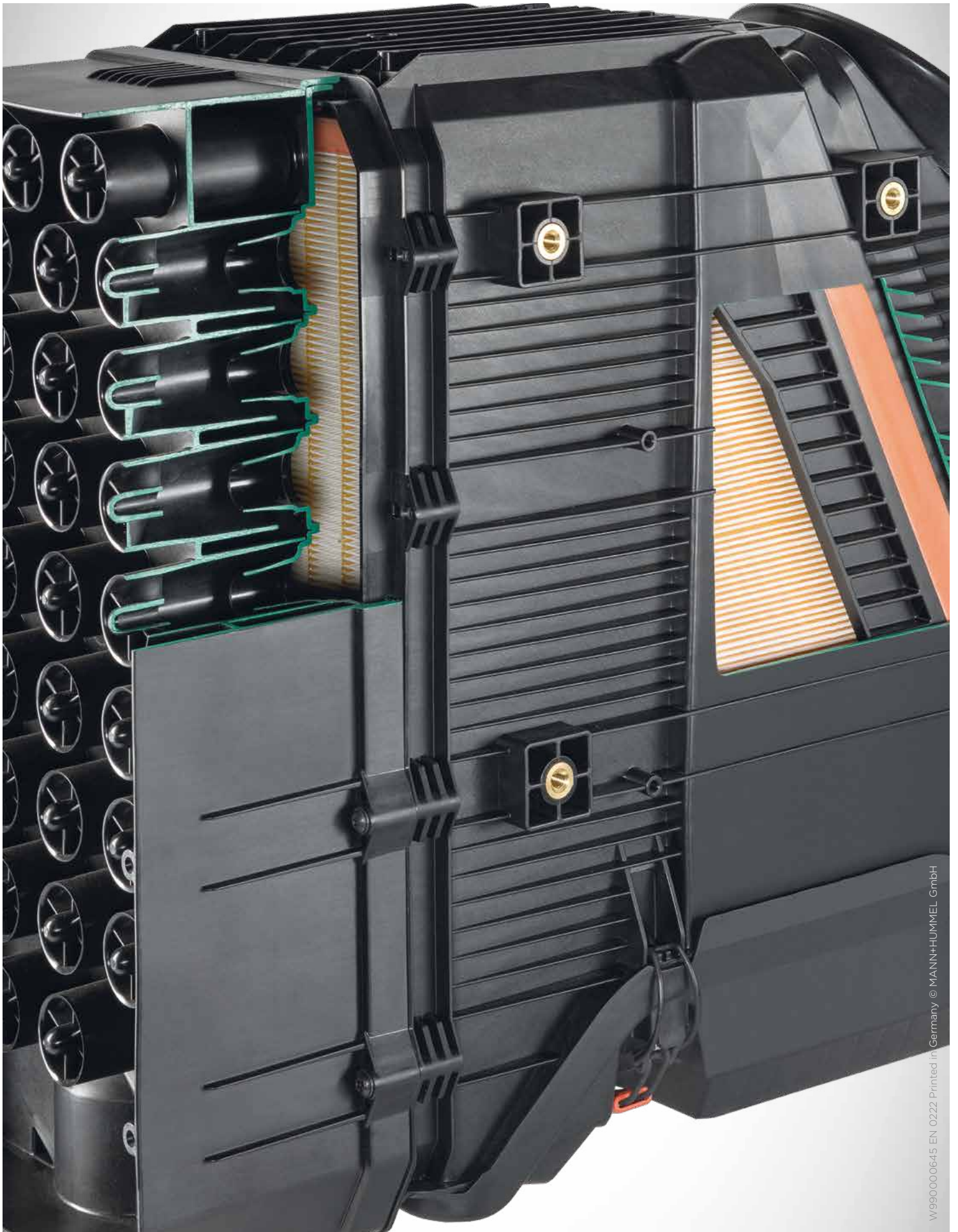

W99000645 EN 0222 Printed in Germany © MANN+HUMMEL GmbH

**MANN +  
HUMMEL**

[www.mann-hummel.com](http://www.mann-hummel.com)