



Engine Liquid Filtration Guide

for Medium & Heavy-duty
Engines, Vehicles and Equipment

Lube



Fuel

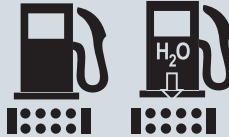

Coolant



Donaldson Delivers!

When you need fuel, lube oil or coolant filtration systems for new and existing engine applications, consider Donaldson as your single source. Our solutions enhance your equipment design, protect your engine components and can improve your overall vehicle maintenance experience.



**WE RAISED THE STANDARD
IN FILTER PERFORMANCE.**

SAY HELLO TO DONALDSON BLUE.

You'll recognize the ultimate in heavy-duty engine filtration solutions. They're Donaldson Blue™. With industry-leading technologies like Synteq XP™ media for fuel and Ultra-Web® media for air filters, you can trust Donaldson Blue to clean in the harshest environments. *Blue Proof* your equipment with proven performance that pays off.

Donaldson.
BLUE™



Further product details are available on pages 76-77 (fuel), 84-85 (lube) and 112 (coolant).

Contamination control is critical for diesel engines

Diesel engine technology continues to evolve quickly in response to increasingly stringent emissions standards. Today's engines now operate at much higher temperatures and under much greater pressures. Because tolerances have become tighter, contamination control for fuel, lube, and coolant systems is critical. Donaldson offers advanced filtration solutions for all engine liquids.

This product guide helps to identify the filtration challenges faced by modern engines and offers a broad array of Donaldson know-how and filtration solutions to meet even the most demanding requirements – yours.

Overview.....2

Product Line Overview	2
Filtration Media Technology	4
Material & Design Features	5
Fuel Filtration Solutions for O.E.M.s	8
Bulk Fuel & Lubricant Filtration	12

Shoptalk.....14

Warranty	14
Filter Servicing Steps	18
Filter Wrenches	21

Fuel Filtration23

Overview	24
Clean Fuel Carts	33
Clean Diesel Kits	34
Filtration Systems - Standard or Modular Filter & Head Designs	35
Water Drain Valves, Sensors & Bowl	57
Replacement Filters (spin-ons, cartridges, box-style, in-line)	59
Filter Kits	72
Donaldson Blue™ DBF5782	76
AdBlue Filter Kits	78

Lube Filtration80

Overview	80
Donaldson Blue™ Extended Service Oil and Filters	85
Oil Analysis	89
Filtration Systems – Filter & Head Designs	91
Replacement Filters (spin-ons & cartridges)	98
Lube Filters for Cummins® ISX Engines	108

Coolant Filtration109

Overview	110
Donaldson Blue™ Extended Service Coolant Filters	114
Filtration Systems – Filter & Head Designs	115
Replacement Filters	116
Hoses	117
Coolant Additives	118
Cooling System Maintenance	120
Cooling System Problems	122

Technical Reference123

Part Number Index.....147

Note: Not all parts listed may be available locally. Please contact your Donaldson representative for availability of parts within your region.

Informative Filtration Knowledge from Donaldson Engineers

Filtration is our Singular Focus

Our focus on filtration began in 1915, when Frank Donaldson created the first air filter for a heavy duty engine. The business has grown steadily, highlighted by the introduction of our first liquid filters over 40 years ago. Today we offer a full portfolio of fuel, lube and coolant solutions for a wide range of on and off-road engines and equipment.

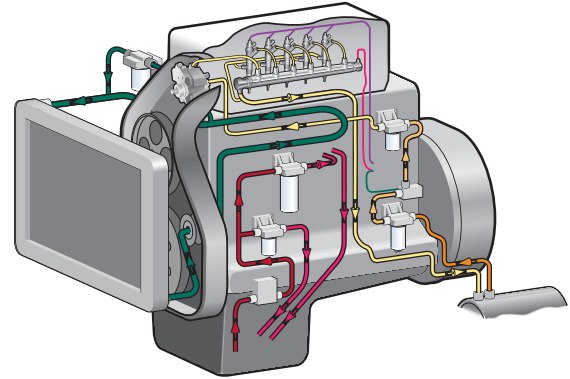

This century of filtration experience is an advantage to our customers. For fleet/equipment owners or original equipment manufacturers, we know what questions to ask, we have ready-made solutions to address the liquid filtration challenges of most standard engines, and we have the experienced engineers to design and efficiently build customized solutions for new engine and equipment platforms. Whatever your filtration challenge – Donaldson Delivers.

Fuel Filtration

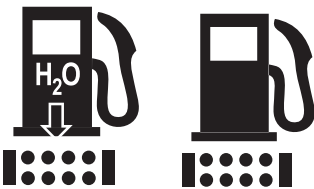

High pressure fuel injection systems require more efficient fuel filtration with longer life. Learn about the features of a system and associated benefits that allow you to weigh the merits of one system's features versus another. For new systems, our heads and filter families provide off-the-shelf options where you can select the proper filter to meet your engine specifications.



Using our blue pages, learn more about biodiesel, alternative fuels and their affect on fuel filtration. This technical section will help provide a greater understanding of fuel and fuel systems.

Fuel Filtration System Application Matrix

Use the matrix below to choose the filtration system that best matches your fuel flow requirements and mounting requirements of your engine. There are multiple filter choices (with and without water separation). The flow range values are for fuel water separating filtration systems. The flow range would be higher if applying a non-water separating filter. Families identified as "modular" should be considered if you're interested in priming pumps and other add-on components.

Mix and Match Fuel Filter Systems		
Families by filter diameter Φ	Flow Range	Features
76 mm / 3.00"	up to 30 gph / 114 lph	Standard design, side mount, single port heads, spin-on filters
80 mm / 3.15"	up to 60 gph / 227 lph	<i>Modular design, side mount, dual port heads, spin-on filters</i>
93 mm / 3.54"	up to 90 gph / 340 lph	<i>Modular design, side mount, dual port heads, spin-on filters</i>
		Standard design, top mount, single port heads, spin-on filters
	up to 160 gph / 606 lph	Standard design, side mount, single port head, spin-on filter (no water sep)
108 mm / 4.25"	up to 180 gph / 881 lph	Standard design, side mount, three port head, spin-on filters
118 mm / 4.65"	up to 250 gph / 946 lph	Standard design, side mount, single port heads, spin-on filters

Standard or Custom Design

The Choice is Yours

Lube Filtration



In our lube section, we cover what's new in oil filtration. New engines have higher operating temperatures. EGR engines are producing higher soot and acid

levels. This requires higher efficiency filters than in years past with the same or longer life.



Learn about standard versus extended drain options for preventative maintenance, and the filter media available for full flow or by-pass filtration. Whether you're strictly an aftermarket consumer of filters or an engine or equipment OEM, Donaldson has options for you.

Lube Filtration System Application Matrix

Mix and Match Lube Filter Systems		
Families by Filter Diameter Φ	Flow Range	Features
93 mm / 3.54"	20 gpm / 76 lpm	Standard design for full flow filtration, top mount, single port head, spin-on filter
118 mm / 4.65"	1.75 gpm / 6.62 lpm @ 85 psi	Standard design for bypass filtration, side mount, single port heads, spin-on filter
	45 gpm / 170 lpm	Standard design for full flow filtration, top mount, single port head, spin-on filters (standard and extended life)

What's Right for Your Engine?

As you develop the future design of your engine or application, it is important to consider the filtration system. Depending on your objectives, it may be beneficial to choose from a standard solution or partner with Donaldson for a custom filtration solution tailored to your needs.

Reasons to Select a Traditional System

- No or low budget for engineering collaboration, development time or cost or component tooling
- Prefer to have parts readily available – want to reduce manufacturing lead times (8-12 weeks) and not interested in warehousing service parts
- Need mix and match head assemblies with various filter performance choices
- Prefer an established brand for filtration

Reasons to Consider a Custom System

- Looking for a system that does more; may include sensors, pumps, and/or heaters
- Interest in component / supplier consolidation – solutions that bridge a wide range of engine/ vehicles.
- Offering a unique solution with ease of maintenance

Coolant Filtration



For engine cooling systems, chemical balance is the key to selecting the right filter for your system. You need to know what type of additives are in your coolant. It's important to select the right filter to support the system to dissipate heat and keep

the system free of contaminants to minimize corrosion and deposits.



Coolant filters are also available to deliver supplemental coolant additives (SCA & SCA+) that dissolve in the coolant to provide corrosion protection.

Filter offering for coolant systems up to 400 gallons / 1500 liters.

Filter Media Technology for Filtration Performance

Donaldson Media Formulations Set the Standard for Filtration Performance!

Donaldson offers extensive filter media technology choices for liquid filters – over 34 different formulations. These formulations enable our engineers to develop filtration systems that exceed or meet a wide variety of customer specifications.

Synthetic media captures more and smaller contaminants than cellulose media. When an application requires higher efficiency filtration than cellulose filter media can deliver, Donaldson uses synthetic media technology.

Look for more information on filtration media available within the fuel, lube and coolant filtration sections.

Synteq XP for Fuel Filtration

This industry-leading media technology used in Donaldson Blue™ fuel filters provides the best contaminant removal and contaminant retention under the dynamic operating conditions that engines and equipment experience every day.



Synteq for Fuel Filtration

This multiple-layered media technology is designed specifically to remove contaminant and water from the fuel stream.

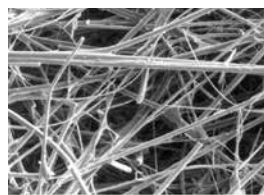

Synteq for Lube Filtration

Synteq filter media technology in Donaldson Blue™ lube filters is ideal for equipment owners who want to extend their oil drain intervals.



Synteq for Coolant Filtration

Synteq media technology is used in our Donaldson Blue™ coolant filters which are designed with the efficiency and capacity to allow for extended service intervals.

Media Durability

Donaldson uses a variety of techniques to enhance filter media so it can withstand the high differential pressures found in typical applications. Oven-curing, wire backing and multiple layers all contribute to our media integrity.

Filter Media Design & Development

From traditional cellulose to nanofiber – the development of proprietary filtration substrates is at the heart of every Donaldson filtration system. If one of our existing media formulations does not meet our customer's specifications, our scientists use our in-house media development laboratory to develop new formulations that meet or exceed your requirements.

Media Characterization Testing

- Proprietary formulations
- Permeability
- Tensile strength
- Mullen burst
- Basis weight
- Pore size
- Thickness
- Gurley stiffness
- LEFS bench
- 3-Point bend



In-House Media Mill

- For application development
- Trial media production runs
- Development of proprietary formulations

Filtration Performance Testing

- Particle counting
- Multi-pass testing
- Water removal efficiency

Materials & Design Characteristics

Designed for Durability

With quality systems and processes in place throughout our entire company, Donaldson customers have come to expect reliable performance and consistent quality.

Baffle Plate

The profile of our baffle plate makes our filters easy to install, reducing the chance of cross threading.

Seams

Fully tucked seams provide added strength and durability.

Inner Seals

In spin-on filters, the inner seal between the baffle plate and filter cartridge is critical. Donaldson filters use a molded elastomer seal.

Gaskets

Designed to withstand the unique chemical properties of fluids (oil, fuel or coolant).

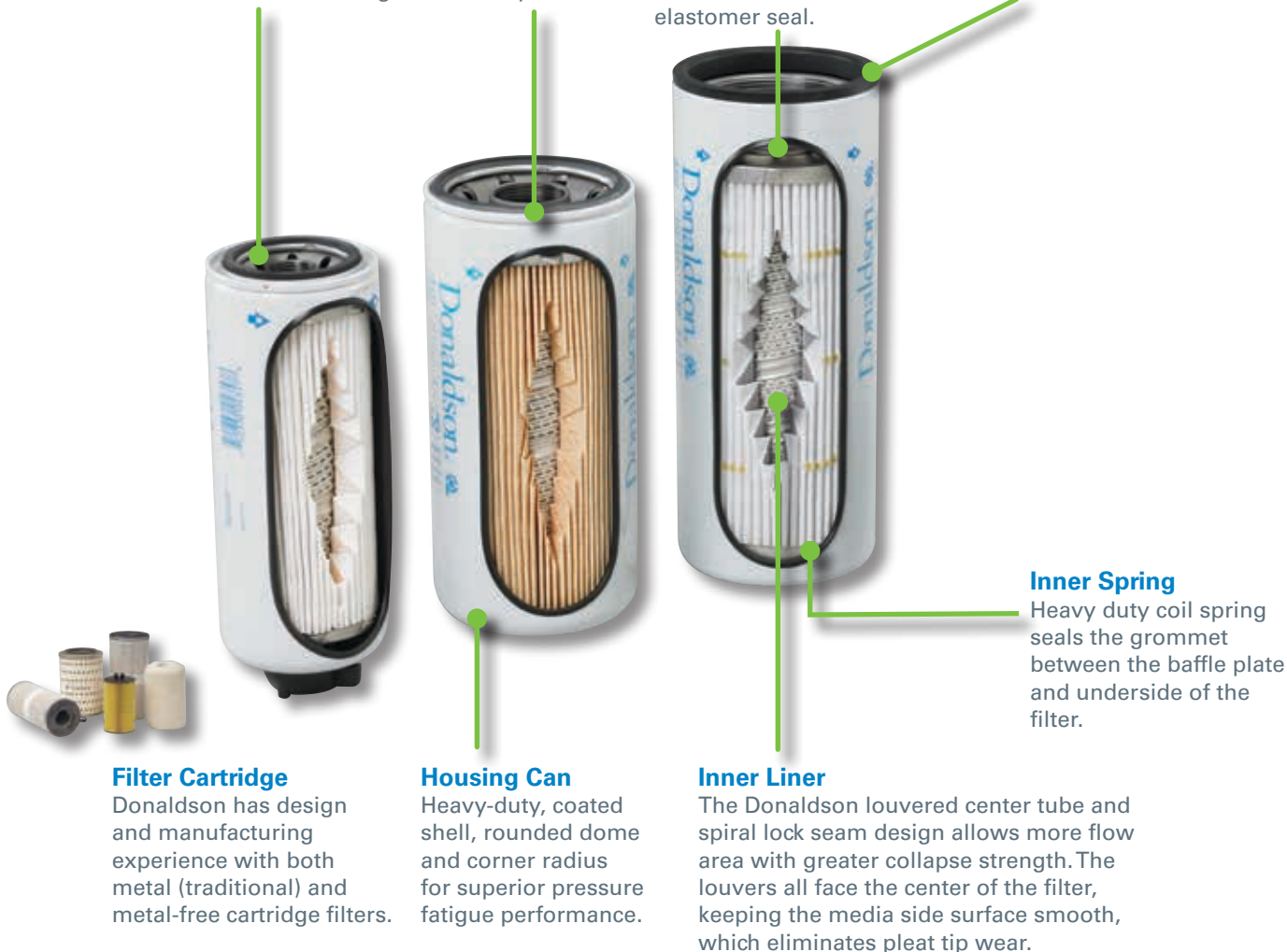

Filter Cartridge

Donaldson has design and manufacturing experience with both metal (traditional) and metal-free cartridge filters.

Housing Can

Heavy-duty, coated shell, rounded dome and corner radius for superior pressure fatigue performance.

Inner Liner

The Donaldson louvered center tube and spiral lock seam design allows more flow area with greater collapse strength. The louvers all face the center of the filter, keeping the media side surface smooth, which eliminates pleat tip wear.

Inner Spring

Heavy duty coil spring seals the grommet between the baffle plate and underside of the filter.

Engine Liquid Filtration Design & Manufacturing Experience

- Lube and fuel filters introduced in 1981, high capacity manufacturing capabilities added in 1988 in N. America
- Duramax® mid-pressure assembly introduced in 1983, spin-on design revolutionized hydraulic filtration industry
- Active participants in industry associations; including ISO and SAE (on committees for hydraulics, lube and fuel)
- Acquired an Italian liquid manufacturing company in 1992
- Expanded liquid manufacturing capabilities in Mexico and Indonesia in 1996
- Added liquid manufacturing in India in 2004
- Added liquid manufacturing to China facility in 2009 to support customer demand

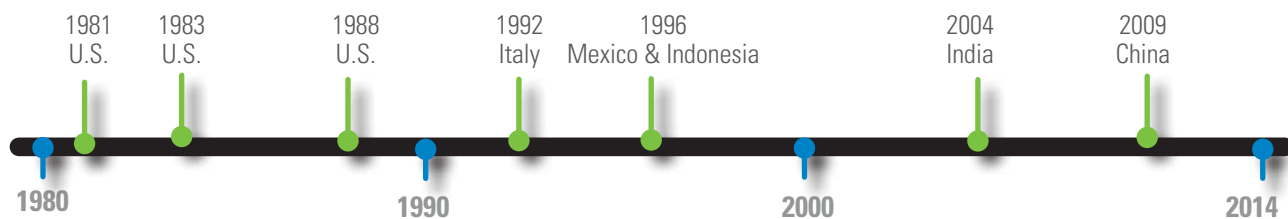

Liquid Filter Design Features

Heavy-duty Design

Heavy-Duty Baffle Plate & Seam

Most heavy-duty liquid filters made by Donaldson have an identifiable baffle plate. They also have open ends that turn up for strength and durability. Competitive products have baffle plates that turn down and in.



- 1 Tapered lead-in thread edge
- 2 Rolled threads
- 3 Inverted Baffle Plate Design
- 4 Full tuck seams

Donaldson Baffle Plate Cross Section

Competitive Baffle Plate Cross Section



Resilient Inner Seal

Not all competitive filters have a seal between the baffle plate and end cap. Donaldson's seal is constructed of molded elastomer that is designed for extreme cold and heat. Some competitive brands use paper, cork and plastic spacer materials that do not last for the service life of the filter and may not be leak tight.



Donaldson Inner Seal

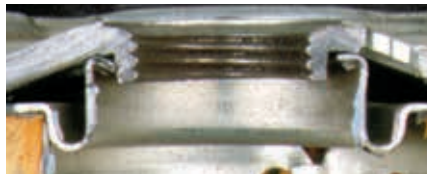

Competitive Cross Section with No Inner Seal



Competitive Cross Section with Plastic Spacer

Heavy-Duty End Cap Seals

A leak will occur in a filter when the end plate and filter do not seal completely. There is no chance of Donaldson filters leaking at this critical point because Donaldson spin-on filter media is embedded deeper in the sealing compound (plastisol, epoxy or urethane) compared to competitive brands.



Donaldson

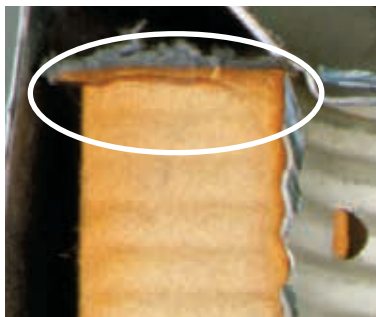

Brand A

Anatomy of a Spin-on Filter

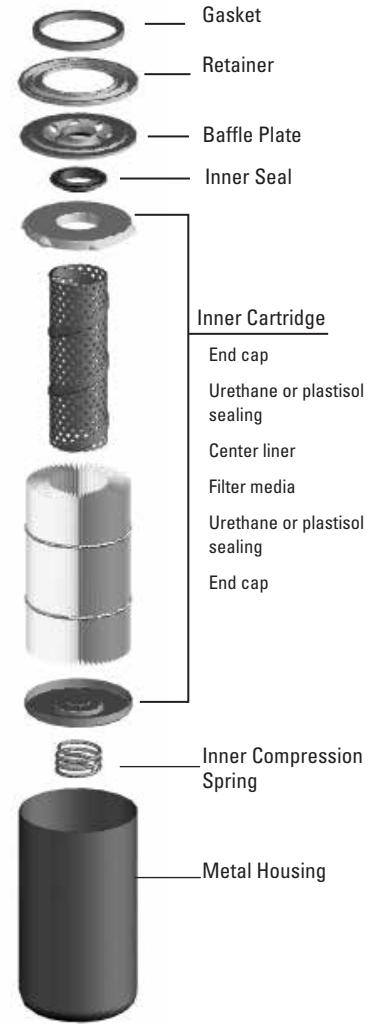

Another no-leak feature is the tabs on the top end cap



Upper End Cap

of the filter element. The tabs prevent the inner cartridge from moving off-center in the housing – preventing leaks and unfiltered fluid from bypassing the filter.

Liquid Filter Design Features

Heavy-duty Design

Filter Media

Curing is the process that adds strength to the filter media and ensures that filter bypass does not occur. Donaldson cures filter media while it is in a flat, pleated state to ensure consistent and even curing. Most competitive brands cure the media after the filter is assembled – leading to poorly cured media in a weakened condition. Uncured media has very low strength and can rupture easily when saturated with oil.



Donaldson cures its filter media (on left) before the filter is assembled, as shown by the consistent color of the entire surface of the filter media. The uneven color variation of the filter media of competitive brands (on right) is an indication that the filter media was cured after filter assembly.

Inner Liner

Donaldson's spiral wound construction allows more flow area without compromising the collapse strength. Sharp edges on holes of competitive tubes can cause media to tear during pleat movement.

Donaldson's louver design has hundreds more flow openings than competitors. The louvers are pushed in towards the inner tube, the surface of which media come in contact with is smooth and pleat tip wear is eliminated.



Donaldson unique center flow tube allows greater flow without compromising strength.



Liners with open holes can cause media tears during pleat movement.

Housing Material & Shape

Donaldson domes and corner radius have superior pressure fatigue performance. Filters with wrench flats or sharp radius edges are more likely to crack sooner than a Donaldson filter.



Donaldson



Brand A



Brand B

Inner Spring or Grommet

These components keeps the internal filter compressed against the baffle plate and seal. Donaldson spin-on filters use coil springs and grommets which compress and rebound under extreme pressure. Competitive brands use a leaf spring which, when compressed, will bend and deform, allowing unfiltered fluid to bypass the filter.



Liquid System Design Features

Electronic sensors, indicators, mounting heads and unique drain valves can be created specifically for your application.



Custom Fuel Filtration Solutions

Synteq XP™ Media Technology

What's New In Fuel Filtration?

- Customized media offerings to meet efficiency and capacity needs for even the most extreme operating conditions
- Common interface can accommodate bowl and non-metal cartridge or traditional metal spin-on filters
 - Provides application flexibility
 - Minimizes environmental impact
- Service choice based on local market demands increase customer satisfaction
- Environmentally responsible
 - meets different global environmental practices through interchangeable bowl and non-metal cartridge or a spin-on filter with the same engine interface
- Enhanced reliability
 - Radial seal technology
 - Structurally stronger
- Longer filter life possible with newer media technologies



Better Fuel Filtration is Key for Modern Fuel Systems

Today's diesel engines need to maintain high performance levels to remain compliant with stringent Tier 4 emissions regulations. Fuel filtration plays a key role, with current high pressure common rail fuel injectors operating at pressures up to 30,000 - 45,000 psi (2,000 - 3,100 bar). This means it's important to deliver CLEAN FUEL to today's precision designed fuel system pumps and injectors to maintain performance.

Today's engines also operate in a wide range of environments that include vibration, fuel pump pulsation and surging fuel flows. It all adds up to big challenges for your fuel filters.

SELECT™ Modular Fuel Solutions

For Low Pressure Fuel Applications up to 60 GHP (227 LPH)

Donaldson SELECT filtration technology provides the latest fuel filtration advancements for Original Equipment Manufacturers. The SELECT system offers highly configurable components that can be packaged with our advanced Synteq XP™ Media Technology – or with other Donaldson media offerings – to address today's fuel challenges.

Component Flexibility

Versatile head options are interchangeable and can be configured with a reusable housing and disposable cartridge or a metal spin-on filter. Heating and sensor add-on options are available.

Environmental Care

Application flexibility designed into the system supports regional environmental practices. For global areas where recycling is the preferred environmental care method, Donaldson offers a metal spin-on options. The alternative, a metal-free cartridge, can be easily crushed or fully incinerated.

Water Management Options

SELECT systems are available with add-on water collection bowls or as a transparent housing. Both options provide quick visual water inspection. Donaldson Twist&Drain™ valves with built in water-in-fuel (WIF) sensors are available for easy water management.

Lead Time Note

This product is configured with the specifications and features of your choice. Further product details on our 80mm fuel family is available on page 39.

Please contact your Donaldson representative for more details.

Industry Shaping Filtration Technology

Synteq XP™ Media Technology

SELECT™ Fuel Product Line Features

SELECT A HEAD

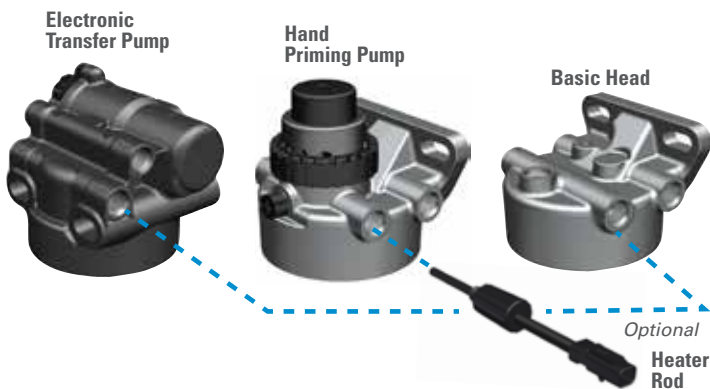

SELECT A FILTER

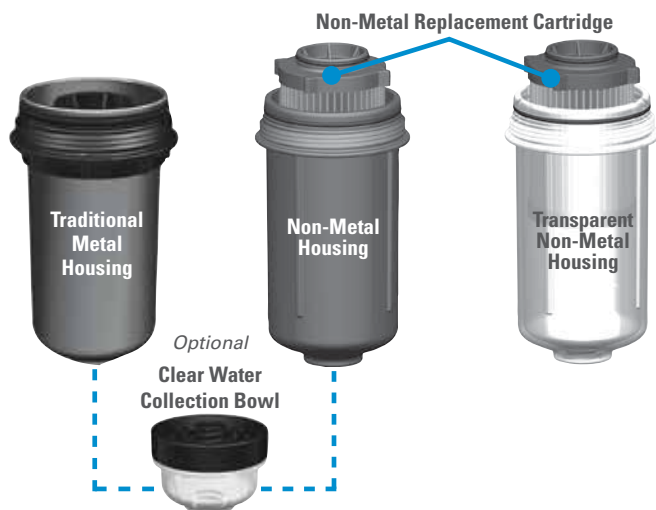

SELECT A DRAIN VALVE

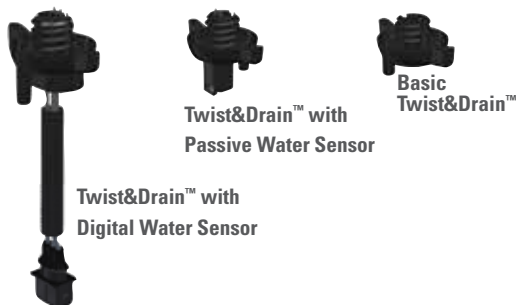

Synteq XP™ Media Technology

Developed specifically to overcome the evolving challenges of today's fuels.

Donaldson's ground-breaking Synteq XP filter media for Tier 4 engines takes fuel filtration performance to a whole new level by providing enhanced engine and system component protection options including:

- Higher efficiency for optimal engine protection, or
- Extended filter life (up to 2 to 3 times that of traditional filter media)

Versatile and smaller filter packaging configuration options are available for secondary fuel filtration.

Synteq XP offers better contaminant removal – and better contaminant retention – all under the dynamic operating conditions that your engines and equipment experience every day.

Donaldson's proprietary Synteq XP nanofiber media creates small, consistent inter-fiber spacing – increasing filter capacity. These unobstructed pores result in reduced pressure drop and increased surface area for capturing and retaining smaller particles.



Resin-free, thermally bonded fibers

During the media manufacturing process, the surface of the binding fiber is heat-fused to bond to the surrounding micro-glass – no resin webbing to block pores.



Global Presence with Local Support

Donaldson is established throughout the world to support global and regional OEM customers. Our locations provide engineering resources, project management, a global sales team, marketing support, manufacturing and distribution at regional levels. Our manufacturing facilities are ISO 14001 and ISO/TS16949 certified.

Unique Fuel & Lube Filtration Solutions

Global Capabilities

Donaldson has accumulated numerous engineering, design and testing tools that are used during the design process.

Engineering Capabilities

- Design centers in three key regions – United States, Asia and Europe

Prediction and Simulation

- CAD
- Media modeling
- Fluid mechanics
- Structural analysis
- Thermal analysis

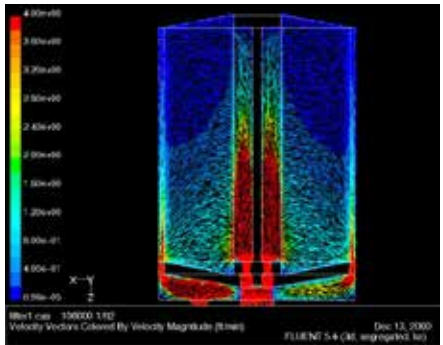

Development and Validation

Filter Durability

- Filtration performance testing per applicable SAE and ISO standards
- Fabrication integrity
- Environmental conditions
 - Salt spray and thermal cycling
- Pressure fatigue
- Flow fatigue
- Hydrostatic burst
- Flow benches
- Vibration benches
- Gravimetric analysis

Rapid Prototyping

- SLA, SLS
- Investment casting
- RTV molding

Test & Evaluation Tools

Structural Analysis

- Per SAE, ISO, and NFPA standards
- Burst
- Collapse
- Pressure impulse and fatigue

Tensile Compression

- Used to test material, component and assembly properties

Environmental Chambers

- Allows testing at hot or cold temperature, with humidity control

Flow Test Benches

- Allows measurement of static and dynamic flow and restriction for a device
- Allows calculation of device restriction at varying flows and temperatures
- System simulation

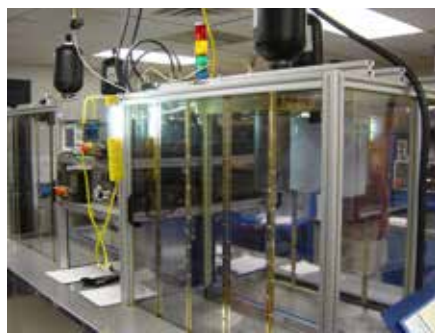

Filtration Performance Testing

- ISO, SAE, NFPA
- Customer standards
- Contaminant (particle or water) removal efficiency
- Contaminant capacity



Analytical Chemistry Laboratory

- Optical microscopy
- Scanning electron microscopy (SEM)
- Chemical analysis
- Fourier transform infrared (FTIR)
- Gas chromatography (GC/MS)
- Thermal analysis (DSC, TGA)
- Liquid chromatography



Unique Fuel & Lube Filtration Solutions

Global Capabilities

Design Validation

Diesel Engine Test Cells

- Test cell locations in three key regions – United States, Asia and Europe
- Up to 600 kW / 800 hp capability
- Measurement of gaseous and particulate emissions
- Used oil analysis
- Component durability
- Soot test bench
- 24/7 durability testing
- Web-based test cell monitoring access



Vibration/Shaker

- Multiple benches
- Performance vibration with flow test
- Can apply sine, random, shock or custom variable vibration profiles
- Capable of hot or cold tests

Field Testing

- On and off highway
- Heavy-duty
- Tests conducted on both end user and OEM vehicles

Field Data Acquisition

- Real time measurements
- Remote communications
- On-line collection tools
- Review daily, weekly and monthly reports to analyze operational trends

Quality Certified

- All facilities are ISO/TS certified

Quality Controls

- Consistent, reliable product
- On-site verification test units and equipment
- Part number specific PLC controls
- Manufacturing dates and lot codes for tracking and warranty

Manufacturing

Locations for Liquid Filtration

- United States, Canada, Mexico, Europe and Asia-Pacific
- Located strategically with global partners



Base Component Materials

- Built for long-life, durability, corrosion resistance and liquid compatibility
- Metal and non-metal materials
- Methods to enhance media durability include oven-curing, wire backing and multiple layered media



Packaging Options

- Returnable packaging
- Heavy-duty packaging
- Pallets ISPM-15 compliant for international routing

Logistics / Distribution

Donaldson has established a global distribution network to serve our customers locally as well as worldwide. We operate as a global company with a network of primary distribution locations that support a mature hub of regional distribution centers and warehouses.

Donaldson distribution centers are strategically located to quickly and accurately deliver filtration and exhaust products wherever replacement products are needed. We work with a network of transportation specialist, logistics companies, consolidators and cross-docking facilities to exceed our customers' requirements.

All regions of the world benefit from our global umbrella of distribution centers. We focus our efforts on local support and the capabilities of our staff. We continue to make significant investments in facilities, systems, supply chain relationships and staffing to offer the best order fulfillment options available.



Bulk Fuel & Lube Filtration

Clean Solutions

Why Filter Bulk Fuels and Oils?

Contaminants and water are enemies of modern diesel engines, robbing vehicles and equipment of performance and longevity. Removing contamination **prior to pumping fluids** into equipment helps on-board filters do their job better, while protecting pumps and injectors.



Achieve More™ with Donaldson Clean Fuel and Lube Solutions

Donaldson offers a range of custom and standard filtration products and services specifically targeted to resolve fuel and bulk oil filtration problems, including:

- On-site surveys
- Facility upgrade options
- Condition monitoring
- Contamination control training/audit
- Installation support, commissioning and fluid management systems
- Support from a local Donaldson distributor for replacement filters and spare parts

Filtration on fuel and bulk oil systems prevents the ingress of solid particulate (dirt) into equipment when filling or topping off tanks. According to one major equipment manufacturer, more than 90% of fuel injection problems are due to unfiltered dirt or water in the fuel*.

With the rise of diesel injection pressures on engines and increasing sophistication of plant machinery, higher cleanliness levels are a reality in today's equipment.



Donaldson bulk filters help:

- Prevent unscheduled downtime
- Save on costly component replacement
- Improve fuel economy
- Protect your investment with confidence

Donaldson has a solution for nearly every filtration need. From bulk filtration for hydraulic fluid to onboard filtration for air and oil, we have a solution that will keep you running.

Need a Clean Solution?

Please contact Donaldson at 855-518-7784 (USA) or via email at clean.solutions@donaldson.com. This will enable us to address your inquiry in the shortest possible time.

* Source: Caterpillar Operators Manual for their D9900 Power Unit and 65 and 70 Diesel Tractors.

Bulk Fuel & Lube Filtration Clean Solutions



Clean fuel quickly and easily by using our Clean Fuel Carts and Clean Diesel Kits.

See pages 33 and 34 of this catalog to learn more about our Clean Fuel Carts and Pump Dispenser Kits. More detailed bulk filtration product information can be found in the *F111500 Bulk Filtration Product Guide*.



MyCleanDIESEL.com



**You depend on diesel for the success of your operations.
You want to understand solutions before you see problems.**

Visit MyCleanDiesel.com to learn how clean diesel can help you Achieve More™.

- Learn the essentials of “clean diesel”:
 - What is clean diesel?
 - Why is clean diesel needed?
 - How do I get clean diesel?
- Learn how to Achieve More™
 - Reduce unplanned downtime
 - Meet or exceed service intervals
 - Optimize fuel efficiency, power, and emissions
 - Prevent rapid filter plugging
- Understand global emissions regulations and why they matter
- Engine technologies such as high pressure common rail (HPCR)
- Understand additives are typically added to diesel and why?
- Learn how fuel is delivered from the refinery to your tank and why it matters
- Find relevant, diverse, new case studies
- Find up to date reference information/websites
- Discover FAQs from people like you who depend diesel for the success of their operation
- Find a solution for your problem
- Understand the solutions before you see the problems
- Contact the global Clean Fuels team in your area get almost immediate responses
- Recognize and solve your diesel-related problems
- Find relevant how-to information
 - Taking good samples
 - Patch testing to measure cleanliness
 - Changing filters

Simple Facts for Owners of Diesel-Powered Equipment

The Shoptalk section contains maintenance tips, cost reduction ideas and product features and benefits.

- Aftermarket Warranty 14
- Watch Out for Dents on Liquid Filters 14
- Diesel Engine Liquid Test Kits 15
- We Set the Standard for Liquid Filtration Performance 14
- Watch Out for Old Compression Gaskets . 14
- Using Donaldson Fuel Filters with Biodiesel 16
- Watch out for Old Compression Gaskets.. 16
- Understanding the Beta Rating System ... 17
- How Big is a Micron? 17
- Filter Recycling..... 17
- Do You Store or Warehouse Filters On-Site? 17
- Filter Servicing Steps 18
- YouTube Servicing Videos..... 19
- Fuel Filter Maintenance Basics 20
- Filter Pictograms..... 20
- Filter Wrenches..... 21

Watch Out for Dents on Liquid Filters

Dents May Cause Cracks

Cracked filters can be caused by dents made during improper installation. Filters that are dented prior to or during installation should not be used. Filters dented after installation should be replaced immediately. The cost of replacing a dented filter is much less than the cost of the damages that could result from a dented filter that fails during service.



Dents in a steel filter canister create a concentration of stress, making the canister more susceptible to fatigue.

Filter fatigue results from pressure pulses within the system. Pressure is regulated by a pressure regulating valve. This valve is spring operated and intermittently opens and closes to regulate pressure. Once pressure exceeds the setting of the spring in the regulating valve, the valve will open and relieve pressure until the spring can expand and close the valve. This function is repeated continuously during operation of the system, creating a pulsing effect. Filter canisters are subjected to the same pulsation. However, unlike the spring in the pressure regulating valve, canister material is susceptible to failure after such fatigue.

Filters are designed with a low carbon steel to resist fatigue and are formed so the stress created by the pulses in the system are equalized over the surface area of the canister. A dent provides an area of stress concentration where pressure pulses can greatly shorten the fatigue life of the canister.

If you receive filters that were dented prior to your receipt, you should contact Donaldson customer support for corrective action.

More information is available through the Filters Manufacturers Council at www.filtercouncil.org

Donaldson Aftermarket Filter Warranty

YOU HAVE A CHOICE

You can always choose top-quality Donaldson filters designed specifically for your engines and equipment. As long as you change them according to the engine manufacturer’s recommendations, using Donaldson filters **will not** void your engine manufacturer’s warranty.



See Brochure F110064 for complete warranty details on all Donaldson products.

www.donaldson.com/en/engine/support/datalibrary/000194.pdf

Diesel Engine Liquid Test Kits

Lube Oil Test Kits

Today's maintenance personnel know that regular monitoring of oil and coolant quality is key to reducing operating costs.

In diesel engine applications, oil analysis is critical to safely extend oil drain intervals with extended service filters, like our Donaldson Endurance line of products.

Oil analysis is critical to proper system and engine performance. Oil analysis service includes:

- Performing equipment tests
- Evaluating test results
- Providing detailed reports
- Specific maintenance recommendations

Interested in Extending Your Oil Drain Intervals?



Today's vehicle and engine owners know that regular monitoring of engine oil is key to reducing operating costs. Setting up an oil analysis program is a great way to monitor the cleanliness of your current oil. This can help determine if you can safely extend your drain intervals.

Combine our oil analysis and the use of premium oil and Donaldson Blue™ premium filtration products and you'll discover how you can safely extend drain intervals and prolong engine and equipment life.



Use X007374 for routine oil analysis for diesel engines reports on wear metals and additives.

Oil Analysis Kit for Fleets and Off-Road Vehicles and Equipment

Kit Part Number X007374

Metals, ppm by wt	◆
Viscosity, cSt.	◆
Water %	◆
Fuel % by Infrared	◆
Soot by Infrared	◆
Glycol (Coolant)	◆

Recommended Sampling Intervals

On-Road Engines

Diesel	10,000 miles / oil change
Gasoline	3,000 miles / oil change
LPG	3,000 miles / oil change
Non-Engines	20,000 miles / 500 hours

Off-Road Engines

Diesel	250 hours / oil change
Gasoline	150 hours / oil change
LPG	150 hours / oil change
Non-Engines	500 hours / monthly

Coolant Test Kit

Diesel engine manufacturers also recommend routine checks of the coolant to make sure your additive packages and coolant chemistry is in balance. The coolant test strip kit tests for freeze protection as well as the concentration of your supplemental coolant additive.

Proper Diesel Engine Coolant Maintenance Requirements:

1. Donaldson coolant filters
2. Low silicate antifreeze
3. Good quality water
4. Protective coolant additive
5. Chemical concentration testing



Our coolant chemistry test (X007684) includes complete test instructions, coolant filter and supplemental coolant additive information and twelve sealed test strips.

Using Donaldson Fuel Filters with Biodiesel

Donaldson fuel filtration products are compatible with OEM approved grades (ASTM D 6571 or EN 14214) of biodiesel blends, up to and including B20 and ULSD fuels.



Biodiesel, n. - a fuel comprised of mono-alkyl esters of long chain fatty acids derived from vegetable oils or animal fats, designated B100, and meeting the requirements of ASTM D 6751 or EN 14214.

Biodiesel blend, n. - a blend of biodiesel meeting ASTM D 6751 or EN 14214 with petroleum-based diesel fuel designated BXX, where XX is the volume percent of biodiesel.

Using High Blends of Biodiesel

Filters that are used in special applications using high blends of biodiesel and those near B100 or unblended B100, should use solvent resistant sealing materials. Continued use of standard sealing materials commonly found on popular fuel filters could result in deterioration or swelling of the material, which may cause leaks.

Avoid Filter Plugging

Filter plugging problems can be prevented by effectively cleaning storage tanks before introducing biodiesel. Filter plugging can also be minimized by using low blends of biodiesel and/or ensuring the biodiesel that you are using is from a quality source meeting the ASTM D 6751/ EN 14214 specifications. BQ-9000® is a quality certification for biodiesel suppliers who provide quality biodiesel meeting the specification in the U.S. & Canada.

Biodiesel is an alternative fuel that is rapidly growing in use. The use of biodiesel that does not meet these industry specifications may cause problems within a fuel system.

More information on ULSD or Biodiesel can be found at www.biodiesel.org

Watch Out for Old Compression Gaskets!



When changing any filter that has a gasket — use caution as old gaskets may stick!

A compression seal is a means of preventing migration of liquids, gases or solid contaminants across a joint or opening in an assembly or housing. A seal not only prevents the escape of fluid from inside and foreign material from entering the system from outside, but it must provide for easy installation and removal. A new gasket is critical for proper filter function.

Remember ...

- Remove used gaskets and clean the sealing area thoroughly
- Always use a new gasket with a replacement filter
- Over-tightening the filter may damage the head
- Dispose of used filters properly

More information is available through the Filters Manufacturers Council at www.filtercouncil.org

Understanding the Beta Rating System

This information is provided as an aid to understanding fluid filter efficiency terminology based on current ISO, ANSI and NFPA test standards.

Additional information on Beta Ratings is available in the Technical Reference section.

What Is Beta Ratio?

Beta ratio (symbolized by β) is a formula used to calculate the filtration efficiency of a particular fluid filter using base data obtained from multi-pass testing.

In a multi-pass test, fluid is continuously injected with a uniform amount of contaminant (i.e., ISO medium test dust) then pumped through the filter unit being tested. Filter efficiency is determined by monitoring fluid contamination levels upstream and downstream of the test filter at specific times. An automatic particle counter is used to determine the contamination level. Through this process an upstream to downstream particle count ratio is developed, known as the beta ratio.

The formula used to calculate the beta ratio is:

$$\text{Beta ratio}_{(x)} = \frac{\text{particle count in upstream fluid}}{\text{particle count in downstream fluid}}$$

where (x) is a given particle size

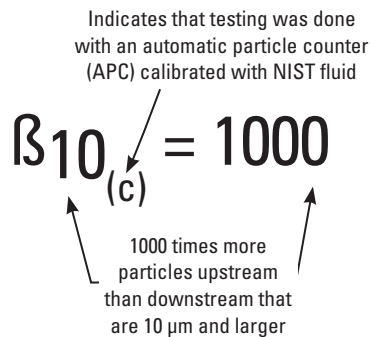

How Big is a Micron?

Micron Sizes of Familiar Particles

Grain of table salt	100 μm
Human hair	80 μm
Lower limit of visibility	40 μm
White blood cell	25 μm
Talcum powder	10 μm
Red blood cell	8 μm
Bacteria	2 μm
Silt	<5 μm

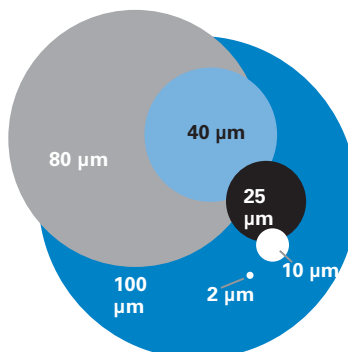

Filter Recycling

Donaldson encourages all individuals and businesses to recycle their used oil filters. Recycling used oil filters helps divert waste from landfills while providing a valuable resource for recycling. We encourage you to check your local disposal regulations for proper disposal and recycling.

Do You Store or Warehouse Filters On-Site?

Whether it's an empty trailer or building, it's important to practice good storage and handling techniques when it comes to filters.

Before installing any filter on a piece of equipment make sure the filter is clean, unused and free of damage.

Filter Storage & Handling Tips

- Never store a filter on a shelf without it being in a box or totally sealed from outside contaminant.
- When you see an open box of filters on the shelf, tape it shut - unless the filters inside the box are individually sealed.
- Handle filters with care to prevent filter damage; for example, don't throw filters into the back of a truck.
- If transporting filters from one job site to another, don't let them roll around on the floorboard or in the back of a truck as it may damage the filter.
- Metal storage shelves may cause condensation to form on filters if sitting directly on metal. Over time the filter may get rusty. Another good reason to store filters in boxes.
- If a product box has layers of contaminant, take care that the contaminant doesn't get on the new filter as you remove it from the box.
- Practice "first-in, first-out" with your inventory. When possible, always use the oldest inventory first.
- Make sure any labels with product information and manufacturing dates are visible to personnel pulling from the shelves.

Filter Servicing Steps

Listed here are recommended practices from Donaldson for servicing and handling engine liquid filters. This servicing information is provided as a best practices guide. Donaldson recommends that where possible, follow the filter service instructions supplied by your original equipment manufacturer. It is not intended to replace or supersede the service instructions supplied by your equipment or vehicle manufacturer.

 FUEL SPIN-ON WATER SEPARATOR	 FUEL DAVCO®-TYPE CARTRIDGE	 FUEL METAL-FREE CARTRIDGE
 1 Disconnect WIF sensor if present and reconnect after servicing	 1 Remove vent cap and seal	 1 Loosen cap slowly; fuel will drain from housing
 2 Unscrew and remove old filter and gasket	 2 Drain fuel	 2 Remove cap, cartridge and gasket if present
 3 Wipe filter head with clean cloth	 3 Remove collar, cover and seal	 3 Remove cartridge and old O-ring from cap
 4 Fill with fuel on the dirty side per engine manufacturer recommendations	 4 Remove cartridge and old grommet	 4 Clean cap and housing with clean cloth
 5 Apply thin film of clean motor oil to gasket	 5 Clean collar, cover and threads	 5 Fit new O-ring and cartridge into cap
 6 Align threads; spin filter on until gasket contact	 6 Check new grommet and install cartridge	 6 Install new gasket if needed; install cap with cartridge
 7 Follow icons on filter to tighten	 7 Install seal, cover and hand tighten collar	 7 Tighten cap to proper torque
 8 Replace water collection bowl gasket if applicable	 8 Fill cover with fuel	 8 Prime fuel system per manufacturer
 9 Prime fuel system per manufacturer	 9 Fit new vent seal and cap and hand tighten	 9 Start engine and check for leaks
 10 Start engine and check for leaks	 10 Start and warm up engine; increase RPM for one minute	
 11 Drain water daily	 11 Slowly open vent cap until fuel rises one inch/25mm above collar; close vent	

DAVCO is a registered trademark of DAVCO Technology, Inc.

Filtration Servicing Videos Available on YouTube®































Thirty servicing videos are available on YouTube as a resource for understanding filtration selection and maintenance. They cover detailed service steps and best practices for fuel, lube and coolant filters. Air intake and hydraulic training modules are also available.

YouTube® is a registered trademark of Google Inc.

YouTube
SERVICE TRAINING VIDEOS



youtube.com/user/donaldsonengine

 LUBE CARTRIDGE	 LUBE SPIN-ON	 COOLANT SPIN-ON
 1 Loosen cap slowly; oil will drain from housing	 1 Unscrew and remove old filter and gasket	 1 Remove radiator cap; caution if hot or under pressure
 2 Remove cap, cartridge and gasket if present	 2 Wipe filter head with a clean cloth	 2 Unscrew and remove old filter and gasket
 3 Remove cartridge and old O-ring from cap	 3 Fill with oil on the dirty side per engine manufacturer recommendations	 3 Wipe filter head with clean cloth
 4 Clean cap and housing with clean cloth	 4 Apply thin film of clean motor oil to gasket	 4 Apply thin film of clean motor oil to gasket
 5 Fit new O-ring and cartridge into cap	 5 Align threads; spin filter on until gasket contact	 5 Align threads; spin filter on until gasket contact
 6 Install new gasket if needed; install cap with cartridge	 6 Follow icons on filter to tighten	 6 Follow icons on filter to tighten
 7 Tighten cap to proper torque	 7 Check oil level	 7 Pour coolant mix into overflow
 8 Check oil level	 8 Start engine and check for leaks	 8 Start engine and check for leaks
 9 Start engine and check for leaks	 9 Stop engine and recheck oil level	 9 Test coolant according to type
 10 Stop engine and recheck oil level		

Fuel Filter Maintenance – Know Your Basics

Best practices for fuel maintenance intervals

- Drain water from your primary filter daily when refueling
- Carry a spare set of fuel filters in case you receive a bad load of fuel
- Never switch to more open filters to get longer filter life - this will reduce fuel pump and injector life
- If using biodiesel, make certain your fuel supplier meets current fuel standards
- Ensure that your engine is compatible with the concentration (or percent) biodiesel you wish to use
- When using your own fuel tank, remember that removing contaminants before they reach the vehicle is the best. Therefore, it is best to use some type of bulk filtration



Filter
Filtro
Filtre



The following pictograms will be used throughout this product guide to help identify our products for use around the world.

Pictograms

Oil
Petróleo
Pétrole
Öl



Engine
Motor
Moteur

Fuel
Combustible
Carburant
Kraftstoff



Coolant
Refrigerante
Liquide de refroidissement
Kühlmittel



Engine
Motor
Moteur



Engine Liquid Filter Pictograms



Engine Oil Filter
Filtro de aceite
Filtre à huile
Ölfiter



Fuel Filter
Filtro de combustible
Filtre à carburant
Kraftstofffilter

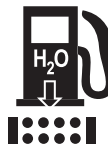

Fuel Filter Water Separator
Filtro separador agua/
combustible
Filtre séparateur eau/carburant
Kraftstoff-Wasserabscheider



Engine Coolant Filter
Filtro para circuito refrigerante
Filtre pour liquide de refroidissement
Kühlwasserfilter

Filter Wrenches

A filter wrench is a specialized tool used to remove spin-on type filters. Spin-on filters are cylindrical and can be difficult to remove by hand. Several types of filter wrenches exist.



Band-Type Wrenches for Truck & Tractor Applications

Extra heavy-duty band-type wrenches available in small, medium and large sizes. Each model has a heavy-duty yoke and a 1-1/2" wide steel band for high torque requirements. Use with 1/2" square drive tools.

Range		Part
Inches	Millimeters	Number
4-1/8" - 4 5/8"	104mm - 118mm	P172973
4-5/8" - 5-1/8"	118mm - 131mm	P172974
5-1/8" - 5-5/8"	131mm - 141mm	P172975

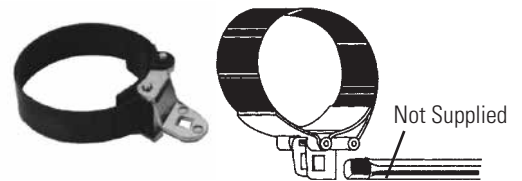

Universal Wrenches

Donaldson carries two styles that fit practically all oil filters. The "Spider" design features three heavy-duty grooved legs driven by a gear mechanism. The strap design is constructed of strong nylon web, which acts as a belt for a non-slip grip - this model can also fit large truck filters.

Range		Part
Inches	Millimeters	Number
2-3/8" - 4-3/4"	61mm-121mm	P172969 Spider
Up to 6"	Up to 152mm	P172970 Strap

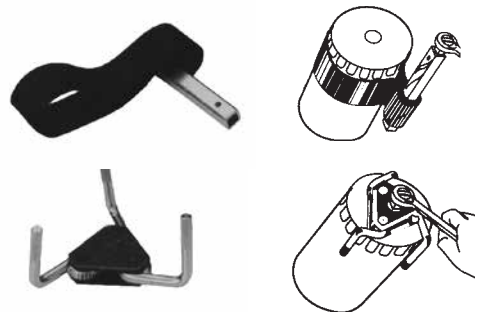

Adjustable, Slot-Design Wrench

This wrench adjusts to a relatively wide range of filter diameters.

Range		Part
Inches	Millimeters	Number
2-3/4" - 4-1/4"	70mm - 108mm	P172972



**WE RAISED THE STANDARD
IN FILTER PERFORMANCE.**

**SAY HELLO TO
DONALDSON
BLUE.**



Now the very best Donaldson technology across a wide range of engine and bulk fuel filtration applications will be easy to recognize — they're all blue.

The Donaldson Blue line includes proven technologies like Ultra-Web® nanofiber media for air filtration (the *original* air intake nanofiber) and new technologies like Synteq XP™ media, which is a game changer for Tier 4 fuel filtration.

With more than 150 air intake, lube, coolant, and on-board fuel filters — plus advanced bulk fuel filtration systems that clean fuel before you pump it into your equipment — Donaldson Blue gives you the broadest premium coverage of any filtration brand. You can trust Donaldson Blue filters to clean in the harshest environments.

Donaldson
BLUE™

Talk to your Donaldson distributor today about making the switch to Donaldson Blue.

Further product details are available on pages 76-77 (fuel), 84-85 (lube) and 112 (coolant).

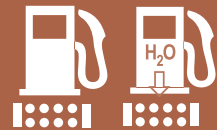

Overview 24-34

- Typical Diesel Engine Fuel Circuit 24
- Harmful Contaminants Found in Fuel Systems 25
- Filter Media 26
- Frequently Asked Questions 30
- Biodiesel Fuel Awareness 31
- Clean Fuel Carts 33
- Clean Diesel Kits 34

Filtration Systems – Standard or Modular Filter & Head Designs..... 35-56

- 76mm / 3.0" dia. x M16-1.5
Flow Range up to 30 gph / 114 lph 36
- 80mm / 3.15" dia. x M94-3
Flow Range up to 60 gph / 227 lph..... 39
- 93mm / 3.54" dia. x M92-2.5
Flow Range up to 90 gph / 341 lph..... 41
- 93mm / 3.54" dia. x 1 3/16"-12
Flow Range up to 90 gph / 341 lph..... 44
- 93mm / 3.54" dia. x 1"-14
Flow Range up to 160 gph / 606 lph..... 47
- 108mm / 4.25" dia. x 1 1/4"-12
Flow Range up to 180 gph / 681 lph..... 51
- 118mm / 4.65" dia. x 1 1/4"-12
Flow Range up to 250 gph / 946 lph..... 53
- 118mm / 4.65" dia. x 1 1/16"-16
Flow Range up to 250 gph / 946 lph..... 55

Water Drain Valves, Sensors & Bowl..... 57

Fuel Filters 59-71

- Spin-on Filters 59
- Stanadyne® FM100 System Fuel Water Separators 64
- Cartridge Filters 65
- DAVCO® Fuel System Filters..... 67
- Metal-Free Fuel Filters..... 67
- Racor® Turbine System Filters..... 67
- Box-Style Cartridge Filters 68
- In-Line Fuel Filters 69

Filter Kits..... 72

- Twist&Drain Filter Kits..... 72
- Australia Filter Kits 74

Donaldson Blue™ DBF5782 76

AdBlue Filter Kits 78



Diesel Engine Fuel Filtration Requirements

Diesel fuel and diesel fuel systems are ever-changing technologies. Over the past decade, numerous emission standards and engineering achievements provided some of the most advanced, clean, and flexible engine designs, yet the advancements have also included the acceptance of alternative forms of fuels such as biodiesel. The next decade is likely to see more change and improvements as diesel engines remain the work horse behind today's industrialized world.

Fuel filter performance and technology have also been challenged by these rapid changes. Today it is common to demand secondary filtration of 3-5 μm absolute efficiency, while matching with an upstream primary filter of 7-25 μm . These changes come with the expectation that water separation, filtration life, and packaging space remain constant or are improved upon. Donaldson engineers have proven to be up to this challenge through the advancement of media technologies.

Fuel filtration today is an integral part of the complete fuel system. A well designed fuel system takes contamination control into account from the beginning. Water separation, particulate and non-traditional contaminants need to be controlled. Engineers must be conscious of the relationship between the fuel circuit design and overall system cleanliness.

Finally, companies must understand global fuel quality concerns and end user needs. Documentation such as the World Wide Fuel Charter exists to promote convergence of various regional practices. Auxiliary user needs such as design type, preferred alternate fuel base stocks, and maintenance practices must be taken into account during the design process. Providing lasting, high quality fuel filtration solutions to our customers is our goal at Donaldson.

Typical Diesel Engine Fuel Circuit

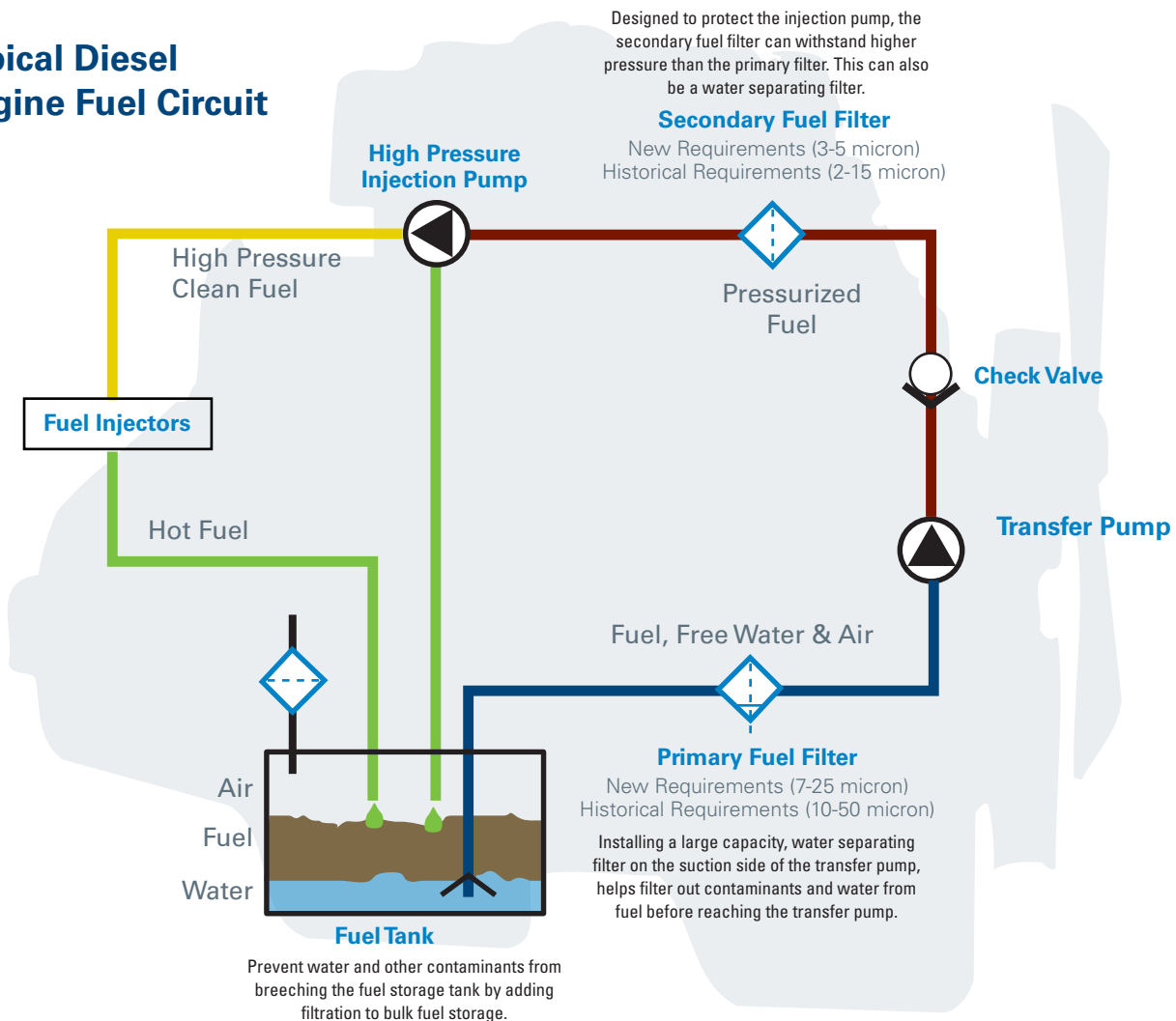



Trends Driving Fuel System Technology Changes

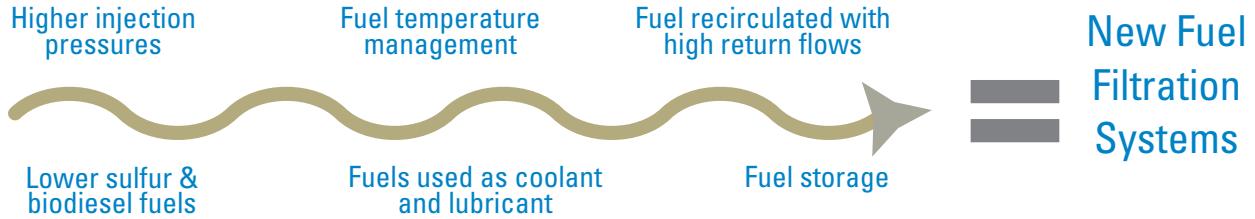

Harmful Contaminants Found in Fuel Systems

Particulate & Debris

Enters when fuel is transferred between storage tanks. Particulates in fuel can disrupt engine combustion and cause wear to the injectors.



Water

Water in the fuel can cause corrosion and reduces the lubricity of fuel. It can negatively affect the combustion process and consequently damage system components. Water enters fuel from storage tanks.



Wax/Paraffin

Drop out of fuel in cold weather conditions.

Microbes (Bacteria)

Can grow in the water at the fuel interface.

Fuel Degradation Products (FDP)

Fuel by-products result from the thermal and oxidative instability of fuel prior to combustion.

Asphaltenes

Found naturally in crude oil and can be found in refined fuel.

Air

Enters the system from leaks in the fuel line or system connections.

How Particulates and Water are Removed

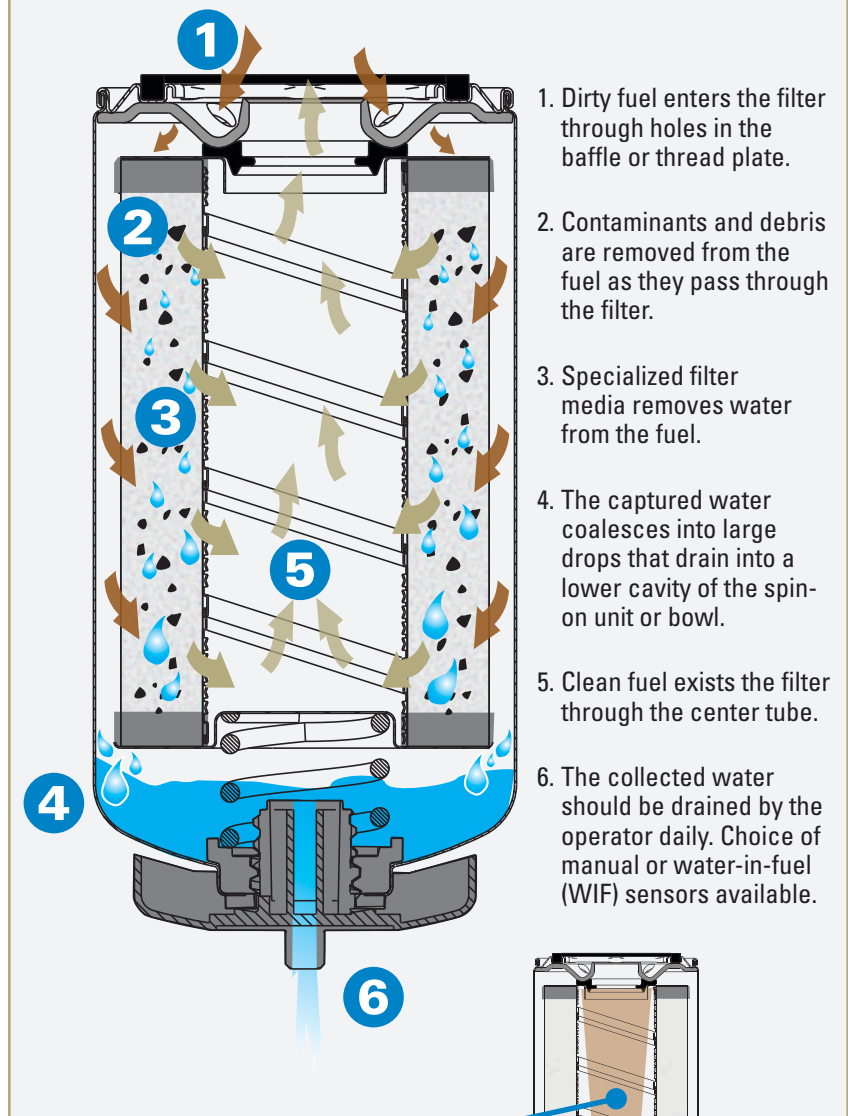

What is a Standpipe?

Found in some applications, a standpipe is built in to the filter to prevent loss of system prime – preventing air from reaching the fuel injection system.



Filter Media

Filtration media represents the foundation of any filter design. Mastering the science of media creation is a key focus at Donaldson. While our customers may not share this same level of understanding, some basics are always helpful. The media representations below highlight some of the more commonly used media types in this evolving industry.

Today's engines are built with more stringent specifications and finer tolerances. Fuel systems, pumps and injectors require cleaner fuel to achieve better combustion and lower emissions. That's why the latest advances in filter media can make the difference between engine power and engine problems.

Cellulose (traditional media)

Fuel filter media is most commonly a pleated cellulose base material. This media is tested for compatibility with a variety of diesel fuels, including biodiesel and ULSD.

Larger particulates are trapped on outer layer, while finer particles are captured deeper in the media.

How it Works

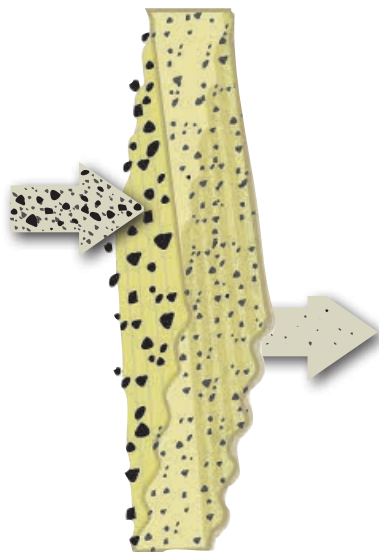

SEM 100x

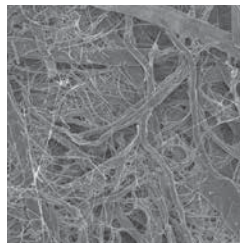

SEM 600x

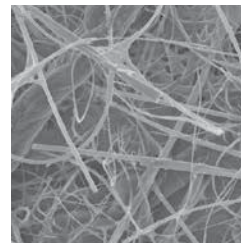

Media Image



Treated Cellulose Media (Fuel Filter Water Separator)

This fuel filter water separator media is a cellulose base material. Treating a cellulose media with a silicone based treatment allows for effective water separation. Typically, this media is used on the suction side of the fuel system to remove harmful water and coarse particulate contaminant.

Water coalesces on media and drains to bottom of can or water collection bowl. Particulate is trapped and held in media.

How it Works



SEM 100x

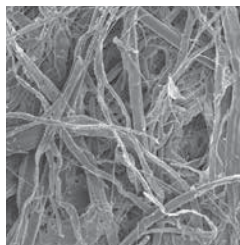

SEM 600x

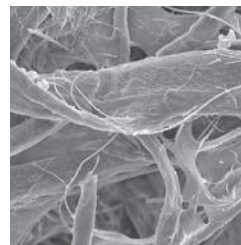

Media Image





Synteq™ Fuel Water Separator Media (Meltblown & Cellulose)

Donaldson's third generation of Synteq fuel filter water separator media uses both cellulose and a meltblown synthetic layer to achieve the highest levels of fuel filtration performance. This double-layered media increases particulate holding capacity and is a high performance water separator. It has the ability for high efficiency emulsified water separation and can be used in both suction and pressure sides of fuel systems.

The polyester layer improves water separation and dirt holding capacity performance. This media is ideal for critical applications or extended service intervals.

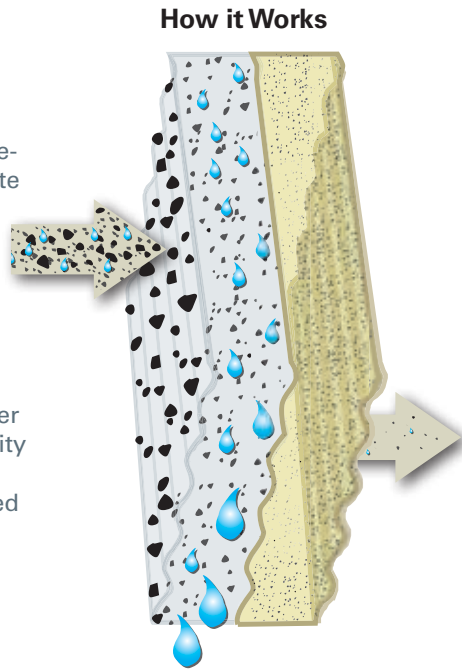

SEM 100x

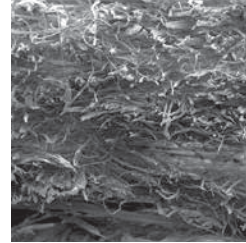

SEM 600x

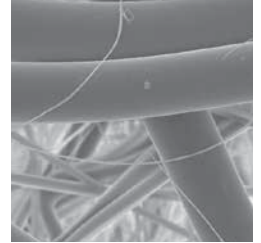

Media Image



Synteq XP™ Media (Synthetic & Cellulose)

High-performance Synteq XP media was developed specifically to overcome the evolving challenges of today's fuels. This ground-breaking filter media takes fuel filtration performance to a whole new level by providing enhanced engine and system component protection options including:

- Higher efficiency for optimal engine protection, or
- Extended filter life (up to 2 to 3 times that of traditional filter media)

Versatile and smaller filter packaging configuration options are available for secondary fuel filtration.

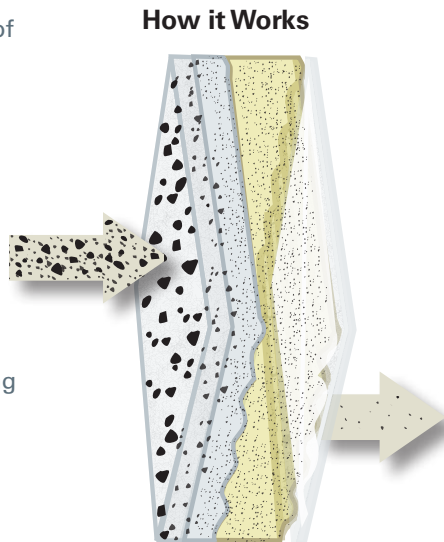

SEM 100x

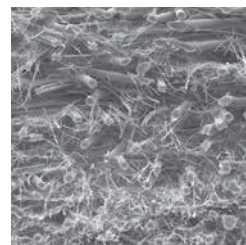

SEM 600x

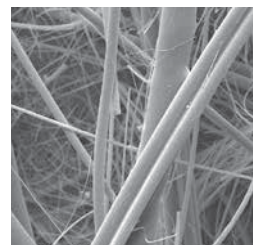

Media Image

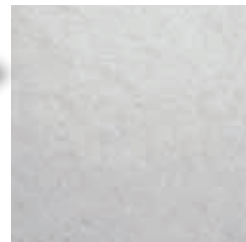

Fuel System Profile

At the end of this publication is a “tear-out” profile form for you to use to convey your system needs to our engineers.

The system profile has a list of all the design considerations required for proper engineering review to determine which Donaldson fuel system would be the optimum solution.

- Fuel System Characteristics - fuel grade, reservoir capacity, fuel flow rates, and temperature
- Filter change interval
- System functions - including water separation, fuel heating, drain, priming pumps, and venting
- Mechanical performance requirements - pressure, fatigue and vibration
- Filtration performance and test conditions
- Fitting and servicing considerations

As with most manufacturers, custom solutions require minimum annual production volumes and a design and development phase. See page 141 for our fuel filtration system design worksheet.

ENGINE FUEL FILTRATION SYSTEM APPLICATION DESIGN WORKSHEET

This form is intended to be filled out by an engineer or buyer that interested in a custom FUEL filtration design system.

For proper development/design engineering solution, we ask you to provide details about your engine, project due dates, fuel system and performance (mechanical and filtered), system mounting, service, final packaging and product markings.

Upon receipt of the form, Donaldson will assess your requirements and get back to you within three working days.

When completed, please forward to Donaldson.
Email: engine@donaldson.com
Fax: 902-887-3059

Company Name: _____ Revision: _____
 Project Name: _____
 Contact Name: _____ Title: _____
 Phone: _____ Fax: _____ Email: _____
 Current Donaldson Model Used: (if applicable) _____ Your Part Number: _____

Engine Information

Manufacturer: _____
 Model: _____
 Displacement: _____
 Number of Cylinders: _____
 Annual Volume: _____

Key System Details

Design Proposal: _____
 Prototype Delivery: _____
 Design Freeze: _____
 PPS: _____
 Start of Production: _____

Fuel System Profile

Primary Filtration Secondary Filtration

Fuel Type:
 Standard grade
 Bio-diesel and max. content
 Alternative

Fuel Delivery System Brand: _____
 Fuel Flow Rates: lpm or gpm
 Minimum _____ Normal _____ Maximum _____
 Fuel System Pressure (kPa):
 Minimum _____ Normal _____ Maximum _____
 Temperature: °C or °F
 Fuel: Min _____ Normal _____ Max _____
 Ambient: Min _____ Normal _____ Max _____
 Fuel Heating: Yes No
 Water Separation: Yes No
 Printing Pump: Yes No
 Air Relief Valve: Yes No
 Water Collection: Bowl No-bowl
 Water Sensor: Analog Digital

Mechanical Performance

Hydrostatic Pressure Resistance (Bar):
 Test Method: _____
 Minimum Value: _____ kPa

More on next page

Fuel Filtration Design Considerations

To properly apply fuel filter systems there must be careful consideration of many different factors. There needs to be an understanding of what is being protected and what level of protection is required. Also, there needs to be a general understanding of the fuel system, where the filters are going to be placed and what the operating parameters are. Most fuel filters used in the engine fuel market are located in one of two positions, primary (pre-filter) or secondary (main filter). The illustration below shows the location and function of these two separate filters. When applying fuel filters to an engine, the filters need to be thought of as a system and how they work together instead of two stand-alone parts.

Primary filters are commonly utilized on the suction side of the fuel transfer pump. This placement allows for protection of the pump while simultaneously taking advantage of easier fuel water separation conditions. Water is typically in larger droplets in the suction side of the system (called coarse water).

If water travels through the transfer pump it becomes mixed in with the fuel in smaller droplets (called emulsified water). Typical micron (μm) ratings for suction side primary filters vary over a wide range. Depending on the vehicle, engine and operating environment, primary filters rated as low as $7\mu\text{m}$, or as high as to over $25\mu\text{m}$, may be employed. The efficiency of the primary filter is determined by the pump requirements, but is usually selected to help balance filter system life.

Secondary filters are usually placed between the transfer and high pressure injection pump. These filters protect the high pressure fuel pump and sensitive fuel injection components from damage due to particulate wear and erosion. Typical ratings for secondary filters in high pressure common rail fuel systems are in the $4\text{-}7\mu\text{m}$ range.

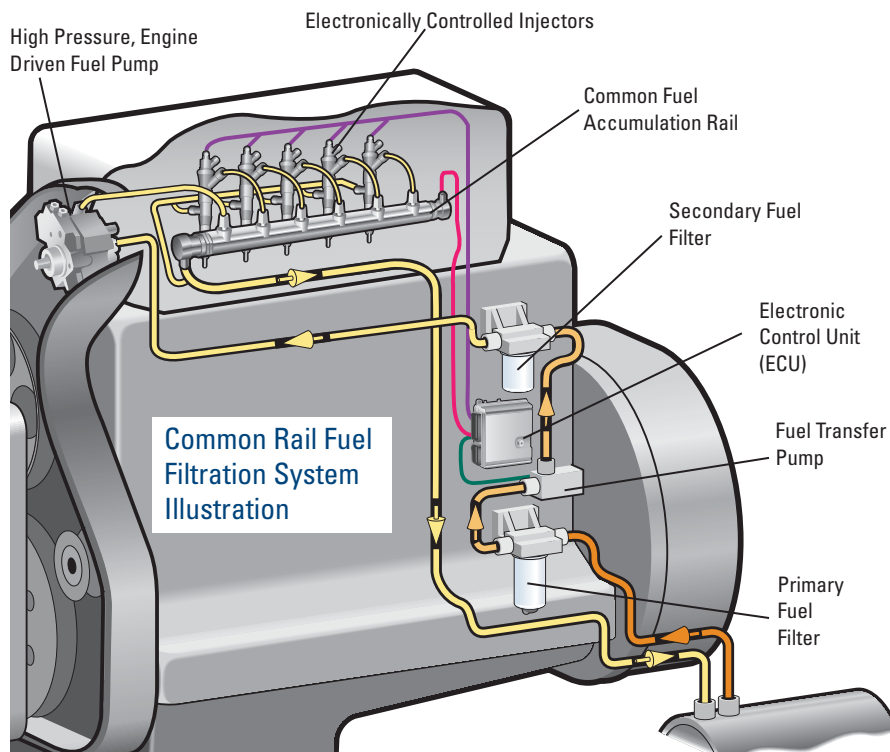



What's Right for your Engine?

As you develop the future design of your engine or application, it is important to consider the filtration system. Depending on your objectives, it may be beneficial to choose a catalog offering or to partner with Donaldson for a filtration solution tailored to your specific needs.

Reasons to Select a Standard System

- Low budget for engineering collaboration, development time or cost of component tooling
- Prefer to have parts readily available – want to avoid manufacturing lead times and not interested in warehousing service parts
- Have a need for mix and match head assemblies with various filter performance choices
- End users who prefer an established brand for filtration

Reasons to Consider a Custom System

- Engine design team is integrating new components that require a higher degree of filtration
- Looking for a system that does more; may include sensors, pumps, and/or heaters
- Have budget for engineering collaboration, development time/cost
- Interest in component / supplier consolidation – solutions that bridge a wide range of engine/vehicles
- Offering a unique solution with ease of maintenance

Liquid Filter Selection Process

Donaldson offers a full line of engine liquid products for a wide variety of applications and operating environments. There are different considerations depending on if you're looking for a filtration system for a new application or if you are looking to upgrade or improve on an existing application.

New System

The following pages feature our catalog heads and filter families that can be used to select standard line products. Choose the product to best suit your requirements and considerations

1. Determine flow range requirements.
2. Determine port size requirements.
3. Determine application filtration efficiency requirements.
4. Evaluate other system design considerations (refer to the application design worksheet on page 141).

Existing Application

Filter application selection for an existing application is best determined by OEM part number cross reference or OEM application make and model. Follow these steps only if the OEM part number or make and model catalog record is not available.

1. Determine filter category e.g. Lube, Fuel.
2. Determine filter type e.g. spin on, cartridge.
3. Determine family e.g. spin-on 93mm diameter, cartridge or competitive housing.
4. Determine other characteristics e.g. spin on thread size, inline fuel inlet/outlet diameter
5. Determine other requirements e.g. anti drain, bypass valve and it's opening pressure.
6. Determine available gasket sealing diameter dimensions.
7. Verify filtration efficiency requirements.



Frequently Asked Questions

Q1: Please explain the differences between the primary and secondary fuel filters in terms of the type of medium used, micron rating, and so forth.

Differences between primary and secondary filters vary from system to system, but in general, primary filters are used to separate water and larger particles (7-25 μm efficiency). Secondary filters are for final filtration (3-5 μm efficiency). Primary filters usually will have treated media to provide water separation performance. This can be either cellulose or a multi-layered synthetic media called melt-blown coupled with cellulose like Donaldson's Synteq™ media. Secondary filters have untreated, multi-layered cellulose or purely synthetic media. These differences mainly have to do with the water separation requirements placed on primary fuel filters.

Q2: Have micron (μm) ratings become smaller and smaller as injection technology has advanced? When replacing filters, how do you make sure you have the micron rating that's appropriate for your generation of engine and its injection system?

As injection technology has advanced and injection system pressures have increased the filtration requirements have become more demanding. These systems have required filtration technology to be more and more efficient. When replacing your filters be sure you use an OEM approved replacement or a direct cross from a reputable filter manufacture to ensure you are using a filter that is appropriate for your engine.

Q3: Some truckers used to use a fine primary filter to avoid changing the secondary, while the original equipment concept was to use a coarse primary (on the suction side) and a fine secondary (on the pressure side). This took extra changes, but they liked the idea of avoiding changing the secondary. Is doing this impractical on modern engines?

Primary and secondary filters are usually balanced to provide the required engine protection and the optimum filter life. Placing a fine filter in a primary (suction) filter location is impractical because they can not tolerate as much pressure drop and will need to be changed very often. Generally, fine filters do not contain the required water separation in a primary filter.

Q4: How have new engine designs affected fuel filtration?

In the past, diesel engines had either mechanical fuel injectors or unit injectors. The drive to develop engine that meet emissions regulations has led to the application of common rail fuel injection systems. The higher pressures of common rail systems enables more precise control of fuel delivery and control of the combustion process. The goal of the new technology is to reduce the particulate matter and NOx coming out of an engine system, thereby reducing the burden on after treatment systems.

The very high pressures in the common rail systems require tighter tolerances, elevating the requirements for cleanliness and efficiency on new and future fuel systems. This has created the need for increasingly better fuel filtration technology. Donaldson offers a range of products for those demanding conditions and is developing solutions for tomorrow's requirements.

Q5: Will common rail systems bring any changes in terms of fuel filter requirements? If so, can you say what will they be?

Most fuel injection systems today are already common rail or close derivatives. The technology itself does not drive specific changes, the injection pressures and desired filter service intervals are more influential.

Q6: How important is filtering fuel stored in bulk tanks?

It's becoming very important and can reduce future vehicle maintenance downtime. If you're using a bulk fuel tank, filtering the fuel BEFORE putting in your vehicle is another great practice that can reduce contaminant and water from the fuel before refilling your vehicle tank. Over time, tanks can corrode, water condensation can build up, contaminant could enter the tank opening during fills.

Q7: I've been handling my diesel the same way for years. Why should I change the way I store fuel?

With the exception of reducing sulfur content, fuel standards have not changed substantially in over a decade. Engines, however, have changed dramatically. In order for new equipment to run trouble-free, they require much cleaner fuel. This means an increased need for filtration. Manufacturers are insistent that damage caused by fuel contaminants is not a factory defect. Therefore, it is in your best interest to filter your fuel prior to use.

**Q8: Shouldn't it be my fuel supplier's responsibility to deliver clean diesel?**

More than likely, your supplier is delivering perfectly in-spec diesel. The problem is that diesel cleanliness specifications are woefully out of date when compared to the needs of the modern engine. Some distributors are starting to go the extra yard and filter diesel prior to delivery, but this is not an industry requirement. An additional note of caution: the term "clean diesel" can also be used when referring to ultra-low sulfur diesel. This is not the same as reduced contamination levels or fuel "cleanliness".

Q9: My fuel filters are plugging up really quickly. Should I change brands?

It is important to use high quality fuel filters to protect your engine. In most cases changing filter brands will NOT solve your fuel problems. Remember, a plugged filter did its job. Rapid filter plugging is an indication that there is a problem with the fuel, not the filter. The key to resolving rapid plugging issues is to determine how filterable solids are getting into or forming inside your fuel tank, and then fixing the root cause. Switching to a lower efficiency filter, regardless of brand, will simply spread the problem throughout your fleet.

Q10: The injectors and fuel pumps on my new equipment keep failing; what can I do?

The first step is to speak with your Original Equipment supplier. If you suspect that dirty fuel is behind the problems, a simple test can verify your fuel cleanliness level. Make sure you put the cleanest fuel possible into your equipment and protect your engine with a high-efficiency fuel filter. This should eliminate injector and fuel pump problems due to dirty fuel.

Q11: Diesel is diesel, right? Why not buy from the cheapest source?

As with anything, you typically get what you pay for. Diesel is expensive, so it is tempting to minimize operating expenses by purchasing the cheapest fuel possible. While this fuel may meet minimum industry standards, that may not be adequate. Small differences in handling practices can have a huge impact on overall fuel quality and cleanliness. Saving a few pennies on your fuel bill may end up costing you far more in downtime, lost production and equipment repairs. Partnering with a good supplier is one of your best defenses against unforeseen fuel quality issues.

Biodiesel – What You Should Know

Biodiesel is a clean burning, renewable, alternative fuel specifically designed for diesel engines. It's produced from domestic renewable sources, including animal fats and plant oils.

Biodiesel blends are created by combining biodiesel with petroleum diesel - allowing it to be used in most diesel engines without any modifications. The blend percentage can vary quite drastically between regions. For example, diesel fuel purchased in Illinois is commonly 11% biodiesel where other states are in the 2% to 5% range. The U.S. Federal Trade Commission (FTC) does not require percentage disclosure to the public for biodiesel blends less than 5%. This may be important for customers experiencing fuel filter life issues.

While biodiesel has many good qualities, it can be a challenge as it relates to filtration. Biodiesel acts as a solvent, so it tends to clean the infrastructure when first introduced, putting a stress on existing filtration. Biodiesel begins to gel or solidify at much higher temperatures than petrodiesel, making it difficult to flow and filter in colder climates. And finally, biodiesel contains glycerin, which even in small quantities can contribute to rapid filter plugging. Your best strategy is to remove any solidified glycerin before it reaches your equipment.

All biodiesels are not created equal.

Know your suppliers and ensure they are providing quality biodiesel. The adoption of biodiesel is still in its infancy. Fuel stations are learning how to specify and store biodiesel properly. Industry specifications ASTM 6751, BQ-9000 and EN 14214 exist for your protection, but alone these do not ensure proper storage. Consider keeping a fuel log to trace issues to specific suppliers.

First time users are often most affected. Older equipment may have built up deposits or certain contaminants throughout the vehicle's fuel system (i.e. tanks, lines, etc.). Even quality biodiesel blends will tend to act as a system solvent. The first time user may experience a period of cleaning and short filter life due to this effect. Be assured that these filters are removing harmful contaminants and the plugging will subside. The most harmful thing one can do during this period is find a more "open" filter that would allow the filter to last longer but would let larger contaminant to pass through to fuel injectors.



Continued, Biodiesel – What You Should Know

When switching from ordinary diesel to biodiesel, flush or clean system first.

When first used in an engine, biodiesel has a cleaning effect. The hydrocarbon deposits that have accumulated throughout your fuel system will be flushed out. These deposits will be trapped in your fuel filter - shortening overall filter life. This issue will resolve itself as you continue to use biodiesel blends.

We recommend cleaning areas of the fuel system located downstream of the filters. There is no filtration protection for the injectors if a deposit breaks free after the secondary filter system. This type of cleaning is similar to changing to organic coolant. For example, all scale will flush away and often end up with leaks.

All Donaldson fuel filters can be used with up to 20% biodiesel blends (B20). For more information about our fuel filters, contact your Donaldson Representative or our Customer Support Team.

Key Points – Impact on Fuel Filtration

- Fuel filters used today are generally compatible with biodiesel blends up to B20
- Most plugging problems can be traced back to the fuel quality
- Recommendations to minimize plugging problems include:
 - Applying bulk filtration on storage tanks.
 - Implementing a preventative maintenance program.
 - Requesting compliance documentation from your fuel supplier.
 - Adding a fuel water separator to older vehicles not already equipped.

Common Causes of Fuel Filter Plugging and Shortened Filter Life

Using the wrong fuel for your operating climate will also shorten filter life. Fuels used in cold climates contain additives to help counteract the effects of the temperature. When using a fuel not intended for a cold climate, the fuel can gel or thicken, plugging the filter and greatly reducing filter life.

Fuel Filter Problems in Cold Weather

Encountering poor quality or unconditioned fuel is inevitable, so some precautions should be made when operating in cold weather. Depending on the severity of winter operating conditions, many operators may choose to protect their equipment through the use of fuel additives, fuel heaters, and fuel water separators.

Q: I use a good cold flow improver, so why do I continue to have so many problems in the winter?

Cold flow improvers, by design, stop small diesel fuel crystals from growing into large diesel fuel crystals (also known as gelling). This in turn lowers the temperature at which the diesel can still flow and be used in the fuel system. With today's HPCR engines, filters are becoming more efficient, and the smaller diesel crystals that used to pass through filters now get trapped just as particulates do. This can cause premature plugging of the filter and decreased life.

Most fuel related winter problems can be avoided using a #1 diesel or a winterized diesel blend.

Engine Power Loss

Diesel engine power loss during winter operation is a common occurrence. Unless there is a component failure within the engine, the problem can usually be traced back to paraffin crystal formation in the fuel which restricts the flow through fuel filters. Freezing temperatures can also cause emulsified water to form a fuel/ice slush, further restricting filters. Often, fuel filters are blamed for the problem when, in fact, the problem is caused by the effect of cold weather on grade #2 diesel fuel.

Cloud Point

The Cloud Point is the temperature at which paraffin or wax, which is naturally present in diesel fuel, begin to form cloudy wax crystals. When the fuel temperature reaches the cloud point, wax crystals flowing with the fuel coat the filter and quickly reduce the fuel flow, starving the engine. Typical cloud point temperatures range from -18°F (-28°C) to +20°F (-7°C), but may occasionally be as high as +40°F (4.4°C).

Grade #1 diesel fuel (or kerosene) contains very little paraffin, and therefore has a cloud point near -40°F (-40°C).

Re-printed with permission of the Filters Manufacturer's Council : Technical Service Bulletin 91-1R3



Clean Fuel Carts Filter Anywhere

Compact, mobile carts are great for fuel transfers and kidney looping. Use it in your workshop, with in-plant machinery, or with mobile equipment to achieve and maintain the ISO cleanliness standards of your fuel.

X011407 AC Clean Fuel Cart

The X011407 features a high-quality 120V-AC PIUSI Panther® 56 pump for up to 15 gpm/56 lpm single-pass or kidney-looped filtration.

X011431 24-volt Clean Fuel Cart

The X011431 features a high-quality 24/12V DC PIUSI® Panther pump for up to 21 gpm/80 lpm single-pass or kidney-looped filtration.

X011408 12-volt DC Clean Fuel Cart

The X011408 features a high-quality 12V DC PIUSI Panther® pump for up to 16 gpm/60 lpm single-pass or kidney-looped filtration.



MyCleanDIESEL.com



**You depend on diesel for the success of your operations.
You want to understand solutions before you see problems.**

Visit MyCleanDiesel.com to learn how clean diesel can help you Achieve More™.

- Learn the essentials of “clean diesel”:
 - What is clean diesel?
 - Why is clean diesel needed?
 - How do I get clean diesel?
- Learn how to Achieve More™
 - Reduce unplanned downtime
 - Meet or exceed service intervals
 - Optimize fuel efficiency, power, and emissions
 - Prevent rapid filter plugging
- Understand global emissions regulations and why they matter
- Engine technologies such as high pressure common rail (HPCR)
- Understand additives are typically added to diesel and why?
- Learn how fuel is delivered from the refinery to your tank and why it matters
- Find relevant, diverse, new case studies
- Find up to date reference information/websites
- Discover FAQs from people like you who depend diesel for the success of their operation
- Find a solution for your problem
- Understand the solutions before you see the problems
- Contact the global Clean Fuels team in your area- get almost immediate responses
- Recognize and solve your diesel-related problems
- Find relevant how-to information
 - Taking good samples
 - Patch testing to measure cleanliness
 - Changing filters



Clean Diesel Kits Clean Fuel In Minutes

Donaldson Clean Diesel Kits are the answer to all your fuel cleanliness worries. You can't always control the cleanliness of diesel fuel delivered to you, but you can control how clean it is when you pump into your vehicles and equipment.

Donaldson Clean Diesel Kits are easy to install on any fuel dispenser and come with everything needed to filter out even the finest contaminants *before* they enter your equipment's fuel system. With the included easy-to-follow, step-by-step instructions, you'll have effective, efficient filtration in minutes.

Every Clean Diesel Kit helps protect your engines, reduce your maintenance costs and prevent unplanned and costly downtime.

Additionally, each kit:

- Provides filtration to ISO 14/13/11 diesel cleanliness in a single pass
- Is recommended for all diesel and biodiesel blends



X011448
Basic Kit includes single head, high efficiency diesel filter and pressure gauge.
For flow rates up to 65 GPM / 246 LPM



X011450
High Capacity Kit includes dual head, high efficiency diesel filters (2), pressure gauge and flange adaptors.
For flow rates up to 125 GPM / 473 LPM



X011449
Clean & Dry Kit includes single head (2), high efficiency diesel filter, water absorbing filter, pressure gauge (2) and T.R.A.P.™ breather.
For flow rates up to 50 GPM / 189 LPM



Filtration Systems – Standard or Modular Designs

The following pages are Donaldson’s catalog product offering for Fuel Assemblies with and without water separation. Within each range there are multiple head assembly and filter choices - including performance and water removal/drain options. Consult Donaldson for a custom solutions.

Use the matrix below to determine the filtration system that best matches your fuel flow requirements, key design requirements and mounting configuration on your engine.

There are multiple filter choices (with and without water separation) within each product families. The flow range values are for fuel filter water separator filtration systems. The flow range will be higher if applying a non-water separating filter. Families identified as "modular" should be considered if you're interested in priming pumps and other add-on components.

Donaldson recommends multiple assemblies in parallel for engine applications with higher flow ranges and horsepower (kilowatt).



Fuel Filtration System Application Matrix

Mix and Match Fuel Filter Systems		
Families by Filter Diameter ϕ	Flow Range Note: flow ranges listed are for water separating applications. Non-water separating designs will go higher.	Features
76 mm / 3.00"	up to 30 gph / 114 lph	Standard design, side mount, single port heads, spin-on filters
80 mm / 3.15"	up to 60 gph / 227 lph	<i>Modular design, side mount, dual port heads, spin-on filters</i>
93 mm / 3.54"	up to 90 gph / 341 lph	<i>Modular design, side mount, dual port heads, spin-on filters</i>
		Standard design, top mount, single port heads, spin-on filters
	up to 160 gph / 606 lph	Standard design, side mount, single port head, spin-on filter (no water sep)
108 mm / 4.25"	up to 180 gph / 881 lph	Standard design, side mount, three port head, spin-on filters
118 mm / 4.65"	up to 250 gph / 946 lph	Standard design, side mount, single port heads, spin-on filters

How Donaldson Displays Filter Flow versus Pressure Loss Data

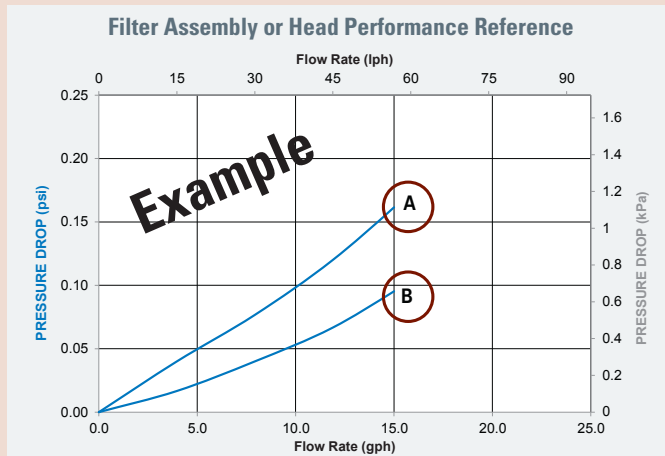

Performance Curve Notes

- Pressure loss was tested per the ISO 3968 standards.
- All flow measurements were made with Ultra Low Sulfur Diesel (ULSD at 80°F (26.6°C)).
- Test conducted with a sample size of three filters.
- Filter performance curves will list an alpha reference (see circled areas on chart). These labels correspond with the filter choice tables.



Fuel Filtration

Filter Dia. 76 MM (3.0") x M16-1.5



Flow Range: up to 30 gph / 114 lph

Operating Pressure

0-100 psi (690 kPa) without bowl

Temperature Range

-40° to 250°F (-40° to 121°C)

Flow Rate

Up to 30 gph / 114 lph

See table for filter flow rates

Fuel Compatibility

#1 or #2 Diesel, Kerosene, Biodiesel up to B20 and JP8

Mounting

Engine or Chassis

Water Removal @ Recommended Flow Rate

SAE J1488 Emulsified: 95% efficiency

SAE J1839 Free Water: 95% efficiency

Air Bleed Vent

Bleed options available

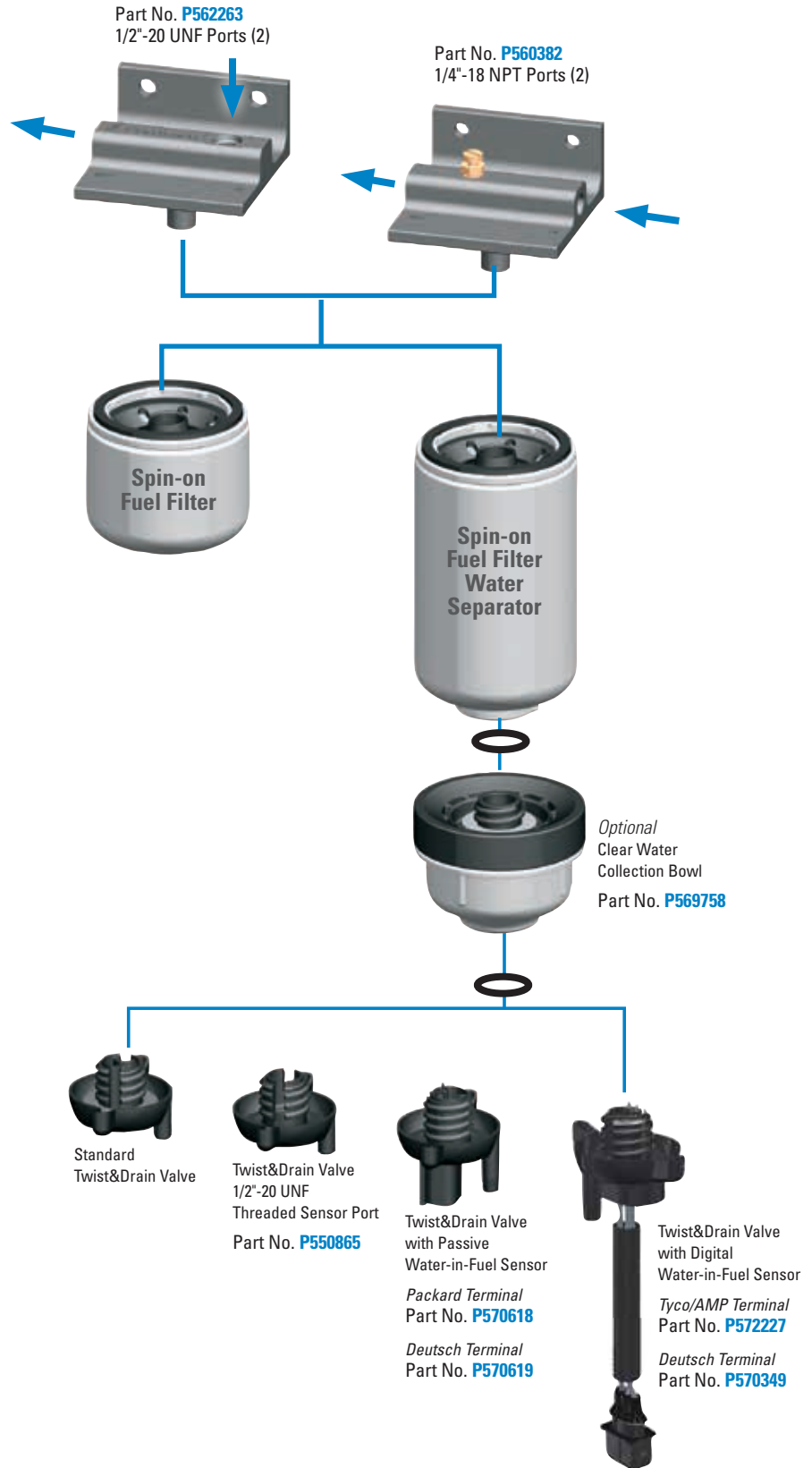



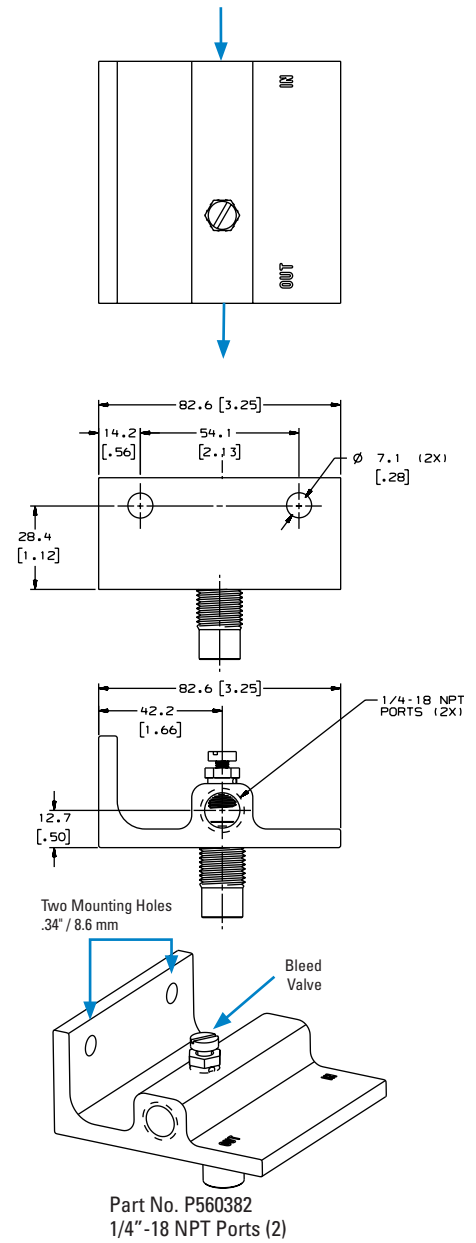
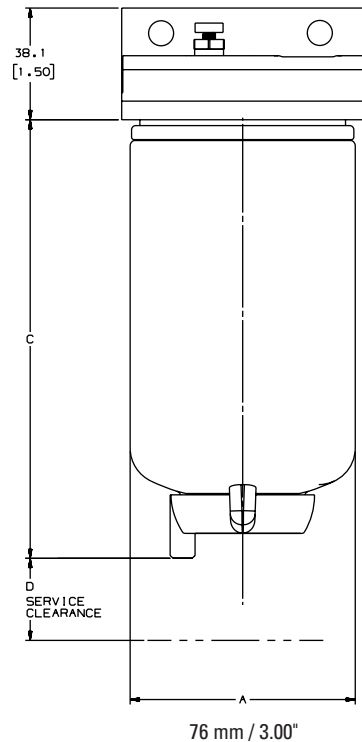
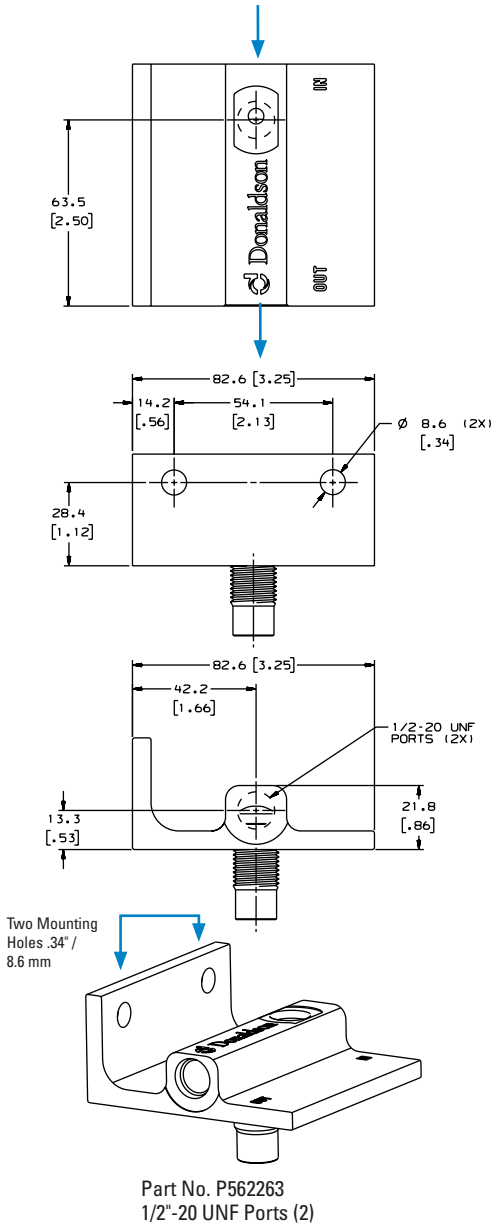

Specification Illustrations





Filter Selection Chart

Filter Style	Max. Recommended Flow Rate		(C) Filter Length*		Media Type	Efficiency @ Micron	Stand Tube	Part Number	Performance Curve	(D) Service Clearance	
	gph	lph	in	mm						in	mm
 Standard Drain	15	57	4.01	102	Treated Cellulose	99% @ 15	No	P551039	B	.93	24
	30	114	5.81	148	Treated Cellulose	99% @ 11	No	P550588	C		
					Synteq	99% @ 3	No	P551615	N/A		
					Treated Cellulose	99% @ 15	Yes	P550248	C		
 No Drain	15	57	3.26	83	Cellulose	99% @ 16	No	P550345	B		
	25	95	4.72	120	Cellulose	99% @ 9	No	P555095	A		
					Cellulose	99% @ 16	Yes	P553004	C		
					Cellulose	99% @ 9	No	P550943	C		
30	114	4.72	120	Cellulose	99% @ 16	Yes	P550440	D			

* Water Collection Bowl (part no. P569758) adds 1.98" / 50 mm to filter length.

Performance Curves

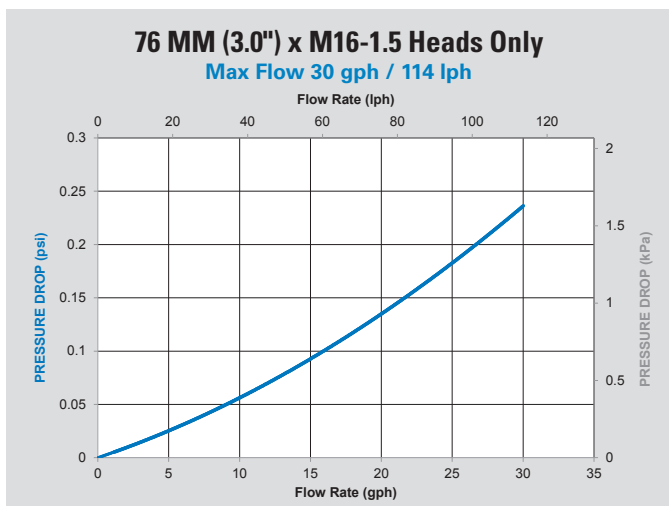
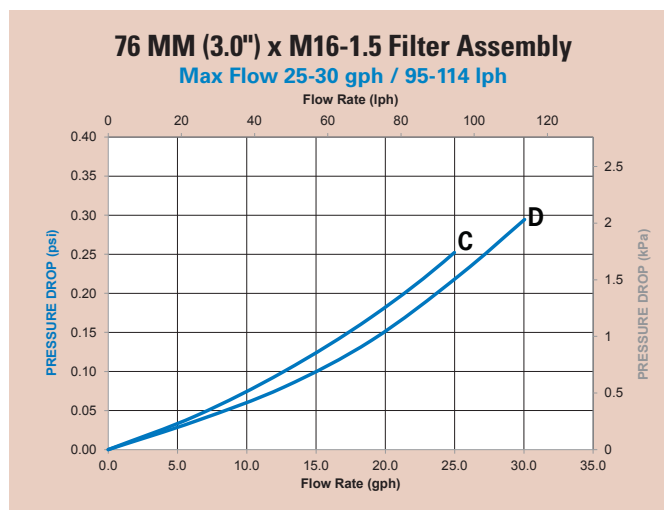
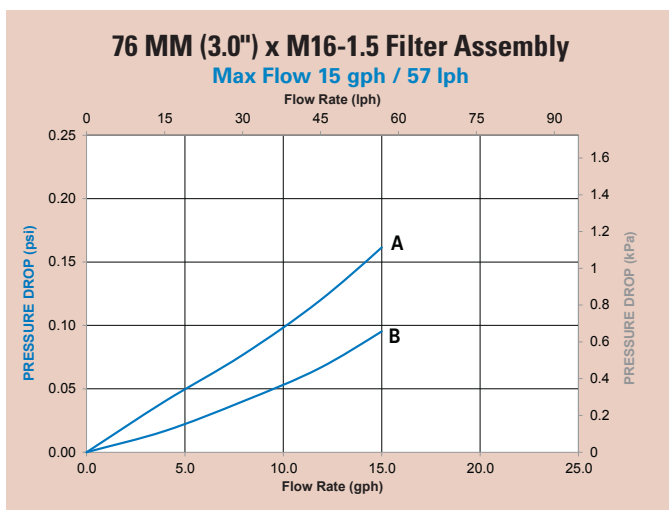



Flow Range: up to 60 gph / 227 lph

Operating Pressure*

0-14.5 psi (100 kPa) with hand pump

Temperature Range

-40° to 250°F (-40° to 121°C)

Flow Rate

Up to 60 gph / 227 lph

Note: Maximum flow rate may be exceeded (up to 400 lph) for non water-separating applications

Fuel Compatibility

#1 or #2 Diesel, Kerosene
Biodiesel up to B100

Mounting

Engine or Chassis

Clean Pressure Drop (Restriction)

At recommended flow rate without check-valve and priming pump

Water Removal

SAE J1488 Emulsified: 95% efficiency
SAE J1839 Free Water: 95% efficiency

Air Bleed Valve

Automatic or manual

Electric Heating Options

12V or 24V

Thermocouple heater rod, or PTC (Positive Temperature Coefficient) heater plate

Porting Size Options

Custom port configuration options:
1/2 - 20 SAE
9/16 - 18 SAE
M14x1.5 mm

Pump Options

Electronic Transfer Pump:
12V or 24V
brushed or brushless motor types
Hand Priming Pump

Media Options

Custom performance packaging with advanced Synteq XP media technology, Synteq or standard cellulose media

* Dependent on application and configuration

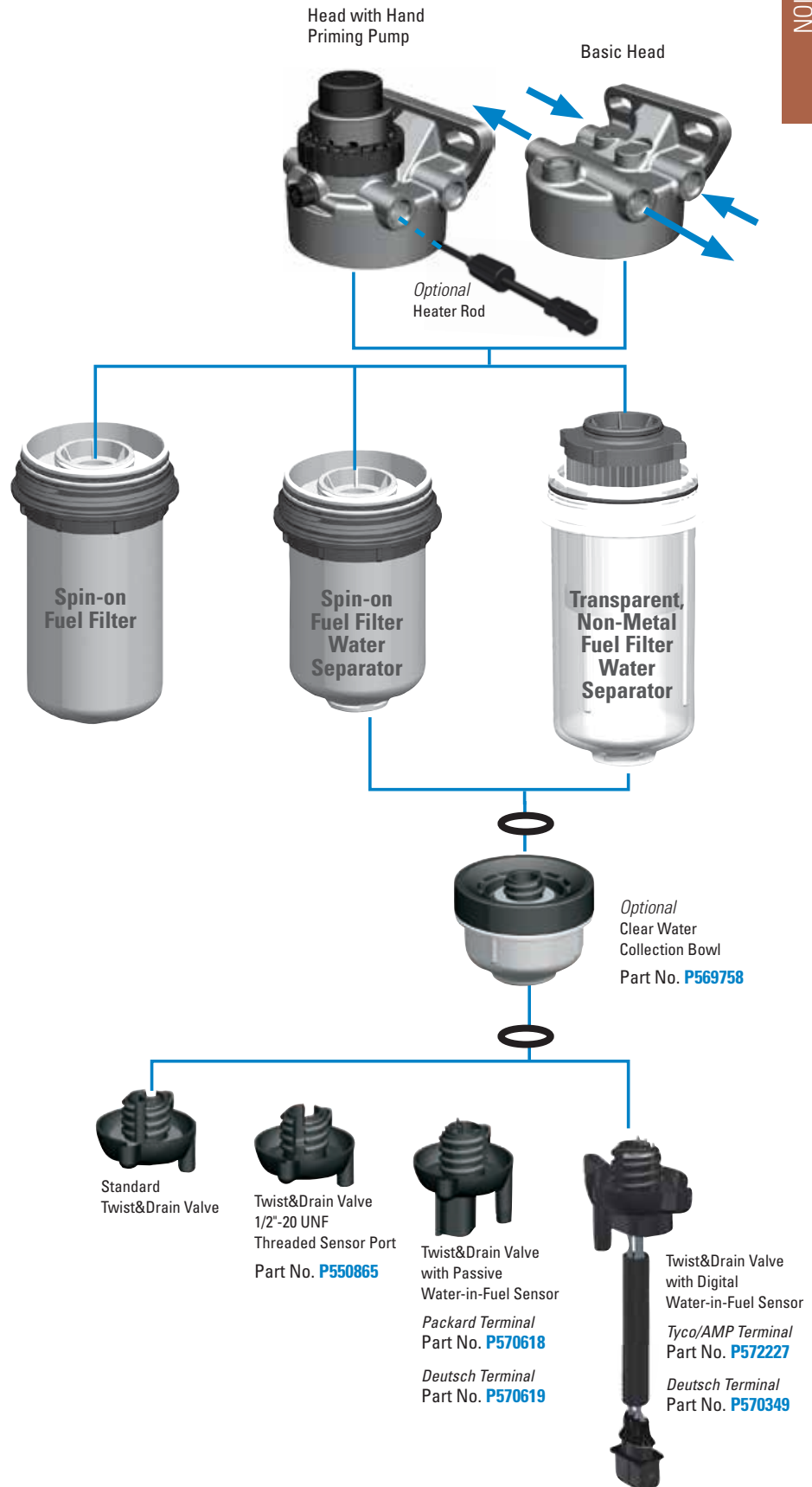



Specification Illustrations

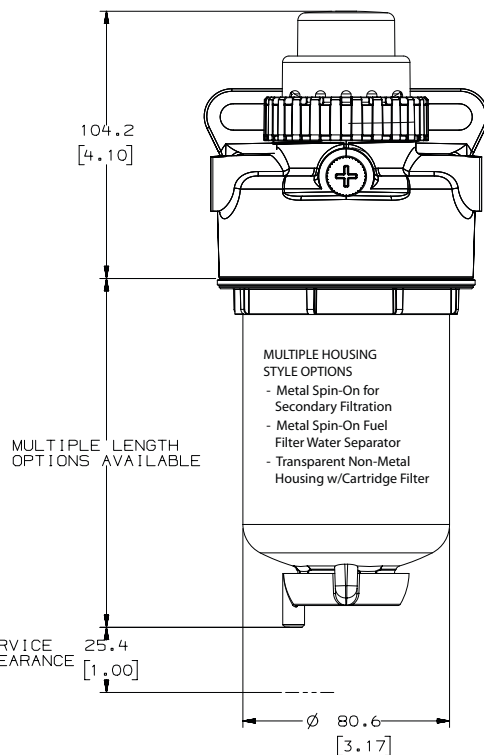
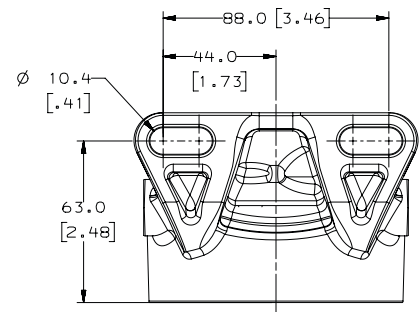
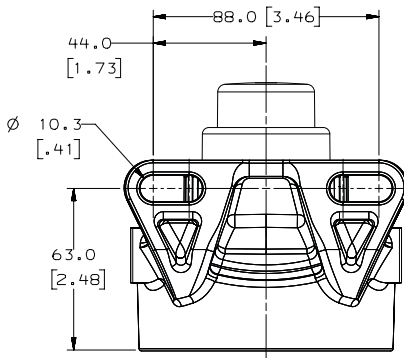
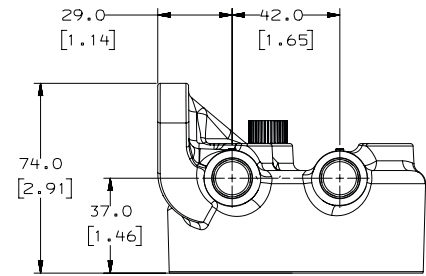
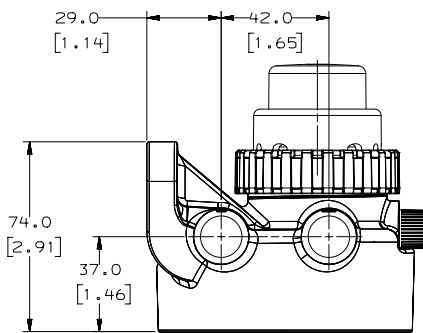
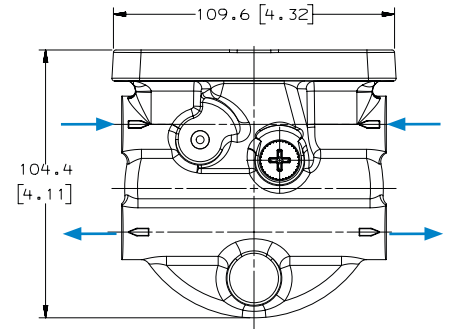
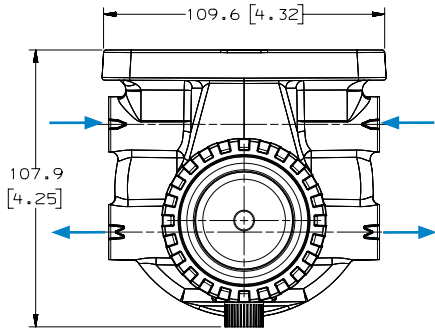

MULTIPLE HOUSING
STYLE OPTIONS
- Metal Spin-On for
Secondary Filtration
- Metal Spin-On Fuel
Filter Water Separator
- Transparent Non-Metal
Housing w/Cartridge Filter

Lead Time Note

This product is configured with the specifications and features of your choice.

Please contact your Donaldson representative for more details.



Flow Range: up to 90 gph / 341 lph

Operating Pressure

Without Drain Bowl:
-40 to 100 psi (-275 to 690 kPa)

Temperature Range

-40° to 250°F (-40° to 121°C)

Flow Rate

Up to 90 gph / 341 lph

Fluid Compatibility

#1 or #2 Diesel, Kerosene, Biodiesel up to B20 and JP8

Mounting

Engine or Chassis

Water Removal @ Recommended Flow Rate

SAE J1488 Emulsified: 95% efficiency
SAE J1839 Free Water: 95% efficiency

Air Bleed Vent

Bleed options available

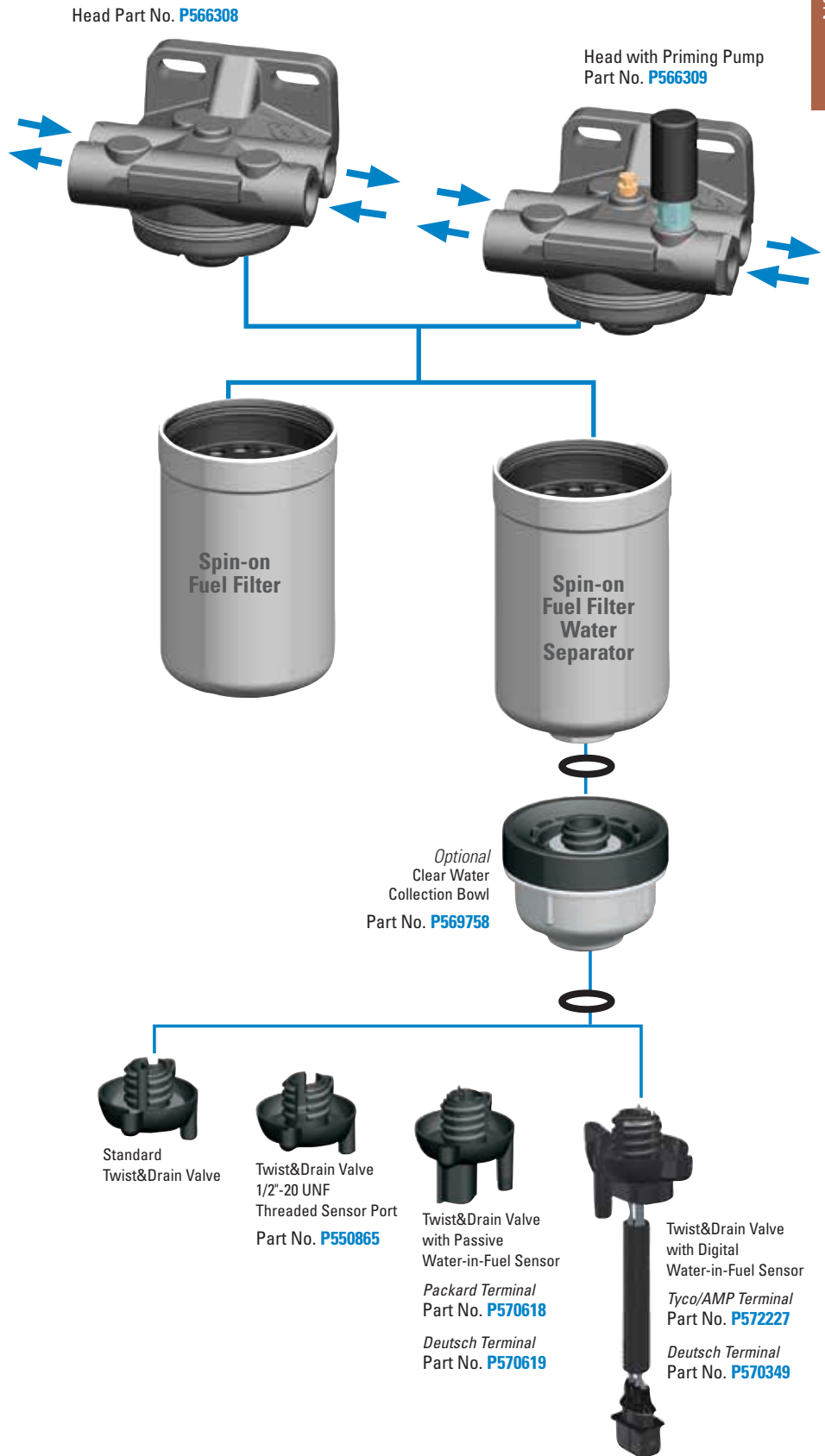



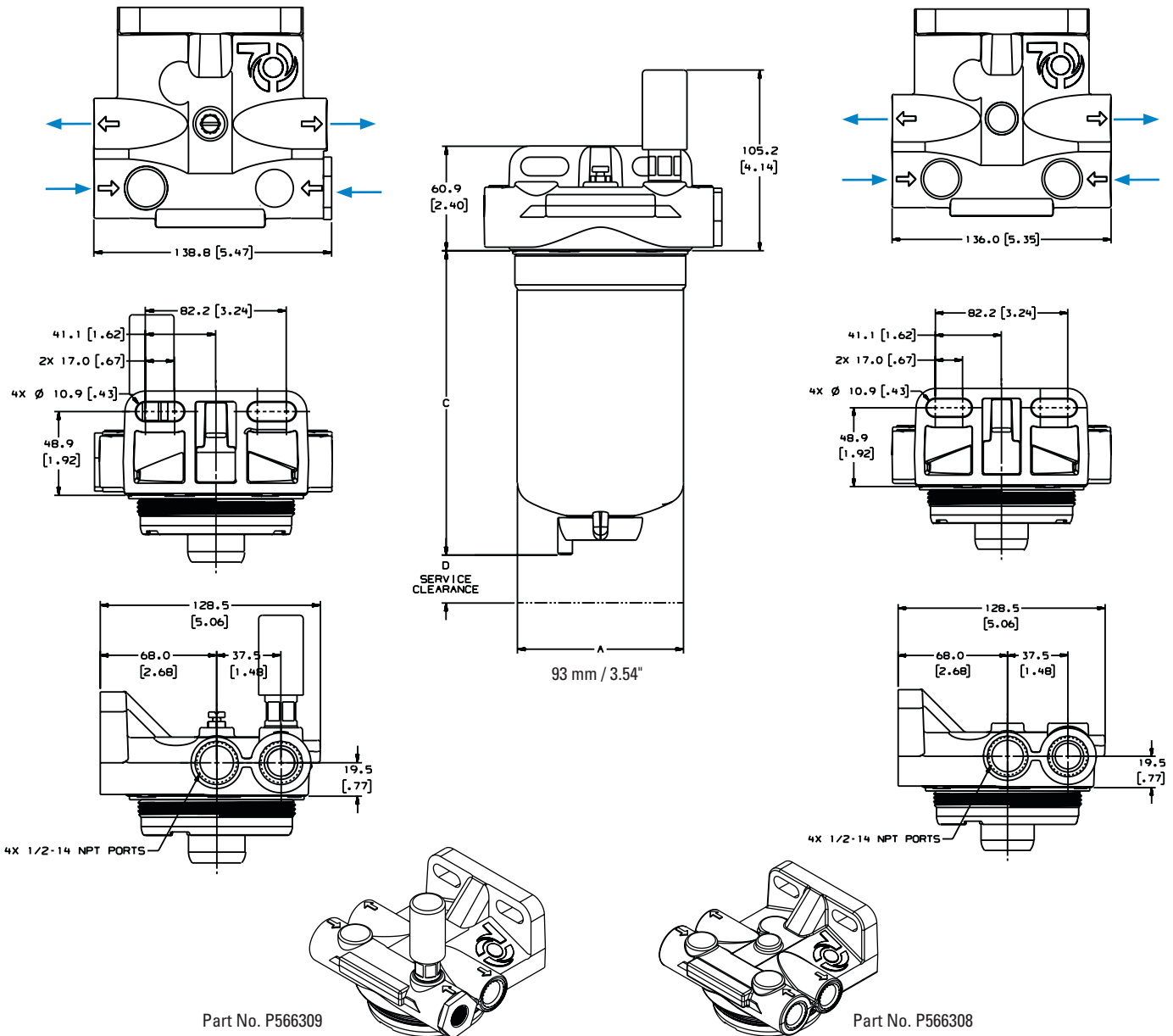

Specification Illustrations





Filter Selection Chart

Filter Style	Max. Recommended Flow Rate		(C) Filter Length*		Media Type	Efficiency @ Micron	Stand Tube	Part Number	Performance Curve	(D) Service Clearance	
	gph	lph	in	mm						in	mm
Standard Drain 	90	341	6.88	175	Cellulose	99% @ 13	No	P566312	C	1.50	38
No Drain 	45	170	6.1	155	Cellulose	99% @ 3	No	P566310	A		
					Cellulose	99% @ 8	No	P566311	B		

* Water Collection Bowl (part no. P569758) adds 1.98" / 50 mm to filter length.

Performance Curves

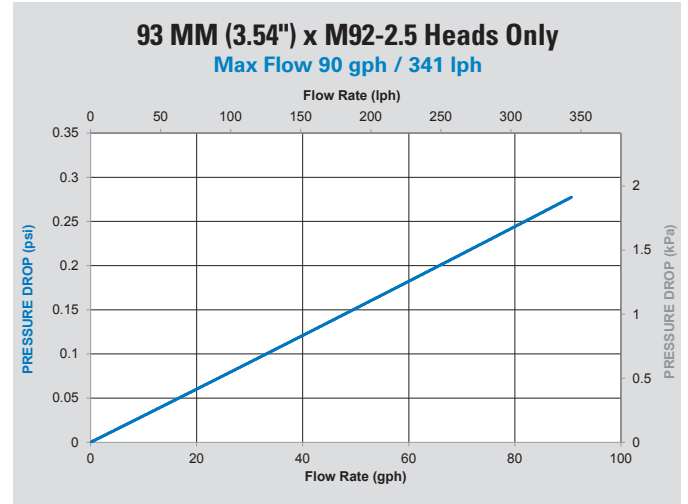
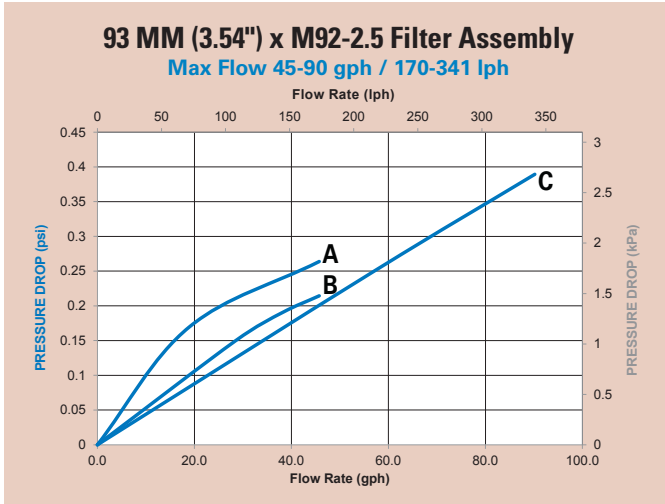



Fuel Filtration

Filter Dia. 93 MM (3.54") x 13/16"-12



Flow Range: up to 90 gph / 340 lph

Operating Pressure
0-100 psi (690 kPa) without bowl

Temperature Range
-40° to 250°F (-40° to 121°C)

Flow Rate
Up to 90 gph / 340 lph
See table for filter flow rates

Fuel Compatibility
#1 or #2 Diesel, Kerosene, Biodiesel up to B20 and JP8

Mounting
Engine or Chassis

Head Part No.
P174785

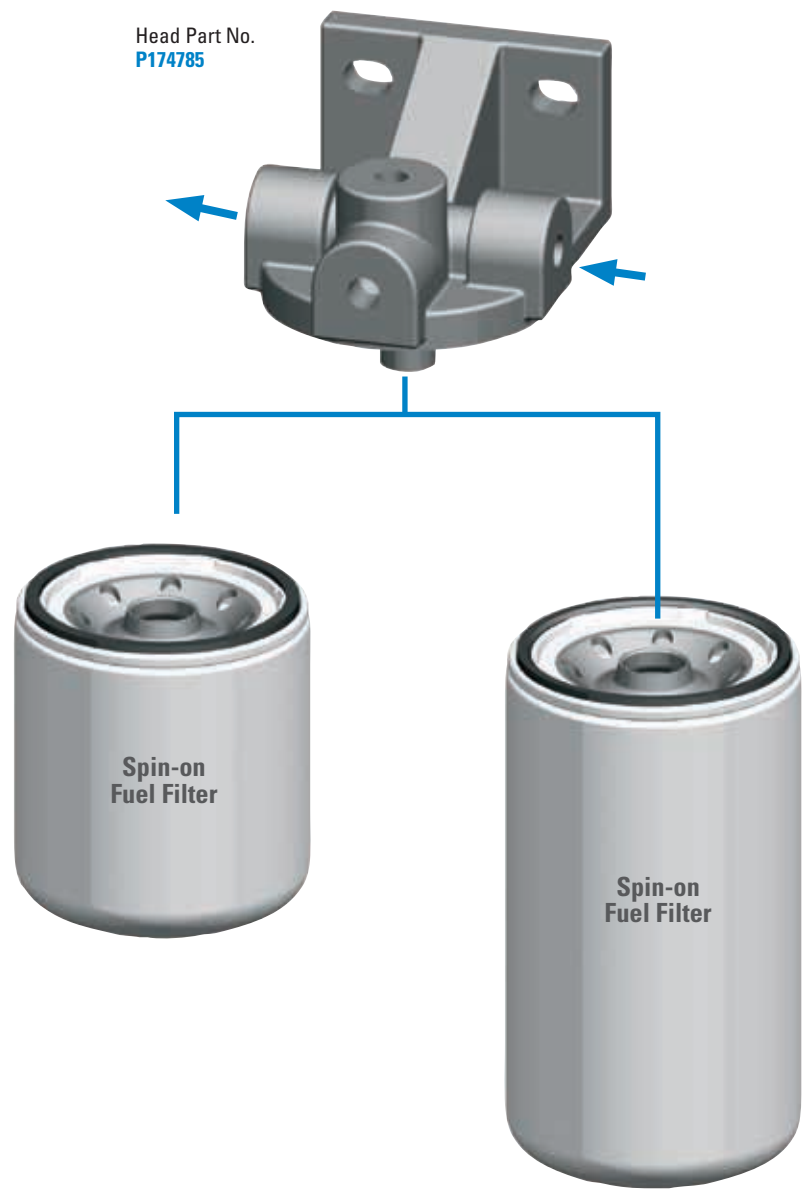



Specification Illustrations

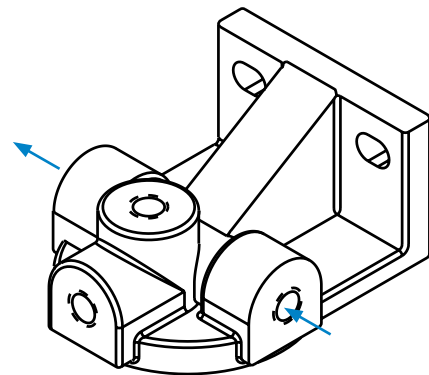
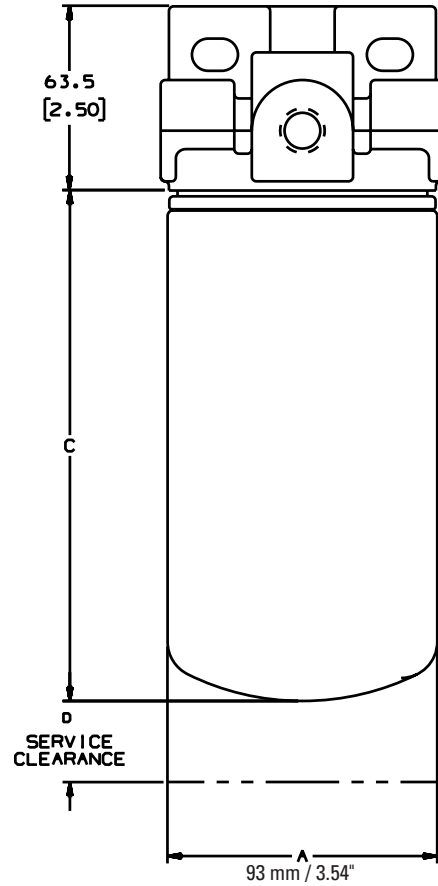
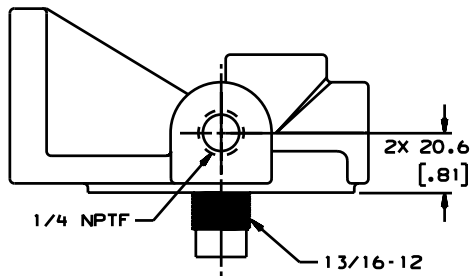
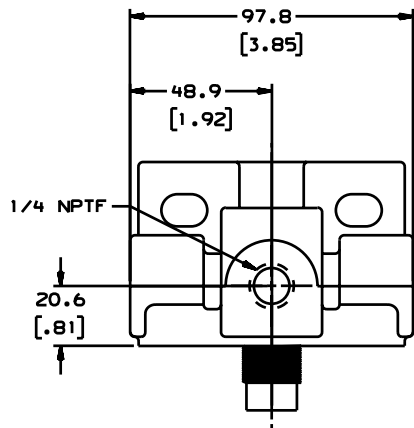
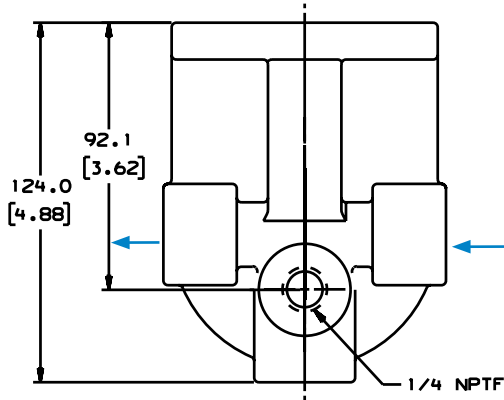



Filter Selection Chart

Filter Style	Max. Recommended Flow Rate		(C) Filter Length		Media Type	Efficiency @ Micron	Stand Tube	Part Number	Performance Curve	(D) Service Clearance	
	gph	lph	in	mm						in	mm
 No Drain	45	170	4.21	107	Cellulose	99% @ 16	No	P550928	B	.90	23
					Synteq	99% @ 5	No	EFF7917	C		
	90	341	6.85	174	Cellulose	99% @ 9	No	P556916	C		
					Cellulose	99% @ 3	No	P556917	A		

Performance Curves

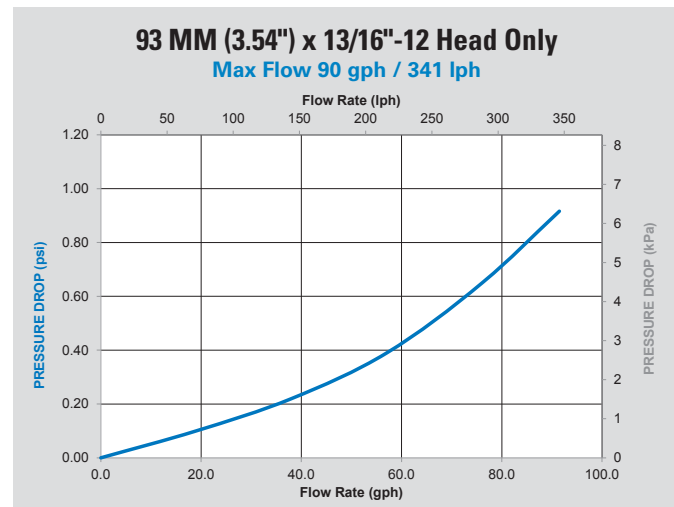
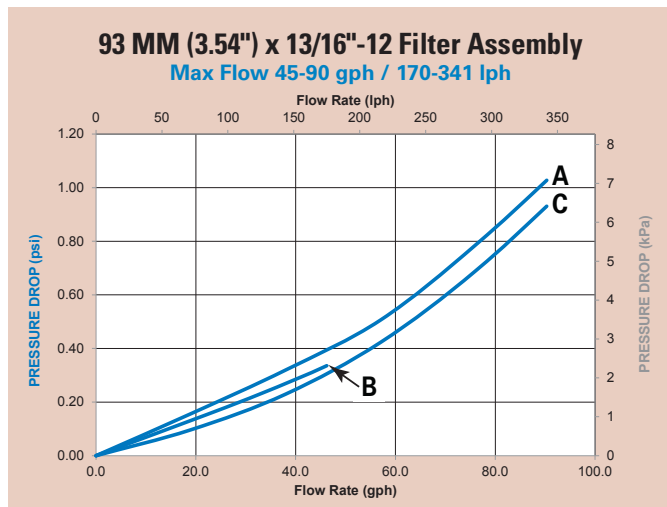



Flow Range: up to 160 gph / 606 lph

Operating Pressure

0-100 psi (690 kPa) without bowl

Temperature Range

-40° to 250°F (-40° to 121°C)

Flow Rate

Up to 160 gph / 606 lph
See table for filter flow rates

Fuel Compatibility

#1 or #2 Diesel, Kerosene, Biodiesel up to B20 and JP8

Mounting

Engine or Chassis

Water Removal @ Recommended Flow Rate

SAE J1488 Emulsified: 95% efficiency
SAE J1839 Free Water: 95% efficiency

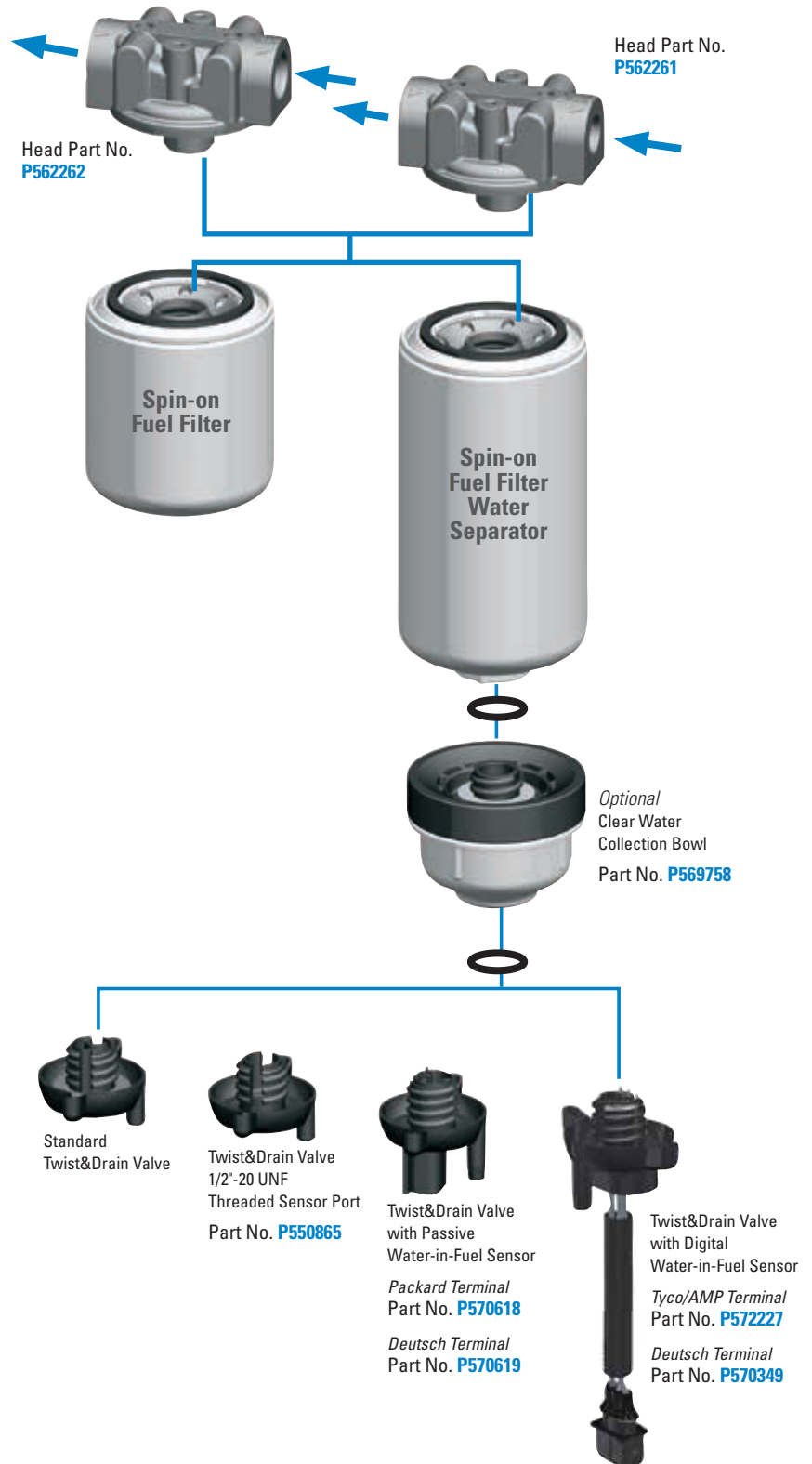



Fuel Filtration

Filter Dia. 93 MM (3.54") x 1"-14



Specification Illustrations

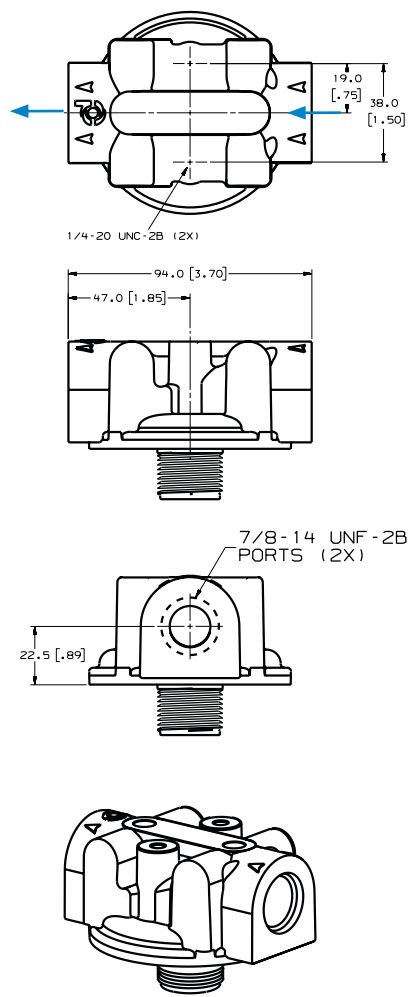

Head Part No. P562262

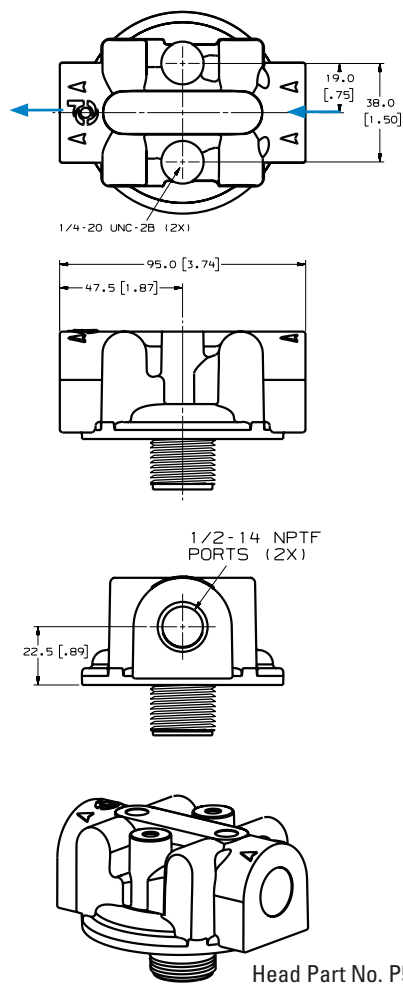
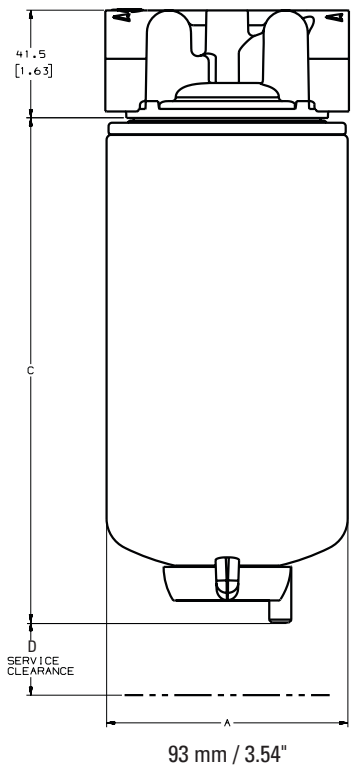

Head Part No. P562261



Filter Selection Chart

Filter Style	Max. Recommended Flow Rate		(C) Filter Length*		Media Type	Efficiency @ Micron	Stand Tube	Part Number	Performance Curve	(D) Service Clearance	
	gph	lph	in	mm						in	mm
Standard Drain 	90	341	7.38	187	Synteq	99% @ 10	No	P550847	G	.87	22
				Treated Cellulose	99% @ 15	No	P558000	G			
			7.61	193	Treated Cellulose	99% @ 3	No	P553203	G		
	100	379	7.68	195	Synteq	99% @ 10	Yes	P551001	J		
				8.64	219	Synteq	99% @ 10	No	P553201		
			Treated Cellulose		99% @ 35	No	P553204	K			
	120	454	9.70	246	Synteq	99% @ 10	Yes	P551000	N		
					Treated Cellulose	99% @ 7	Yes	P550901	N		
	Drain Valve for Deutsch WIF Sensor 	100	379	8.40	213	Synteq	99% @ 10	No	P550848		
120		454	9.01	229	Synteq	99% @ 10	Yes	P551122	N		
					Synteq	99% @ 10	Yes	P551103	N		
Drain Valve for 1/2"-20 UNF Threaded Port Sensor 	90	341	7.61	193	Treated Cellulose	99% @ 3	No	P553213	E		
					Synteq	99% @ 10	No	P553211	G		
			8.64	219	Treated Cellulose	99% @ 35	No	P553214	H		
	Treated Cellulose	99% @ 3			No	P553217	F				
	120	454	9.22	234	Synteq	99% @ 10	No	P552032	N		
No Drain 	40	150	4.22	107	Cellulose	99% @ 25	No	P550104	B		
	60	227	5.35	136	Cellulose	99% @ 25	No	P550105	C		
					Cellulose	99% @ 17	No	P552251	C		
			5.78	147	Wire Mesh	95% @ 140	No	P552203	C		
	80	303	6.85	174	Cellulose	99% @ 25	No	P553854	D		
					Cellulose	99% @ 9	No	P557440	A		
	100	379	6.95	177	Cellulose	99% @ 3	No	P551313	I		
					7.40	188	Cellulose	99% @ 25	No	P550106	J
			7.87	200	Cellulose	99% @ 9	No	P555627	I		
	120	454	8.69	221	Cellulose	99% @ 15	No	P552253	N		
	160	606	9.43	240	Cellulose	99% @ 9	No	P551712	M		
					Cellulose	99% @ 3	No	P551311	L		

* Water Collection Bowl (part no. P569758) adds 1.98" / 50 mm to filter length.



Performance Curves

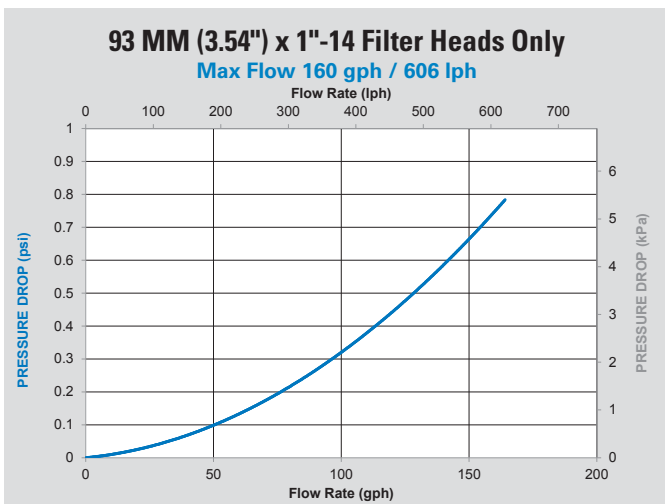
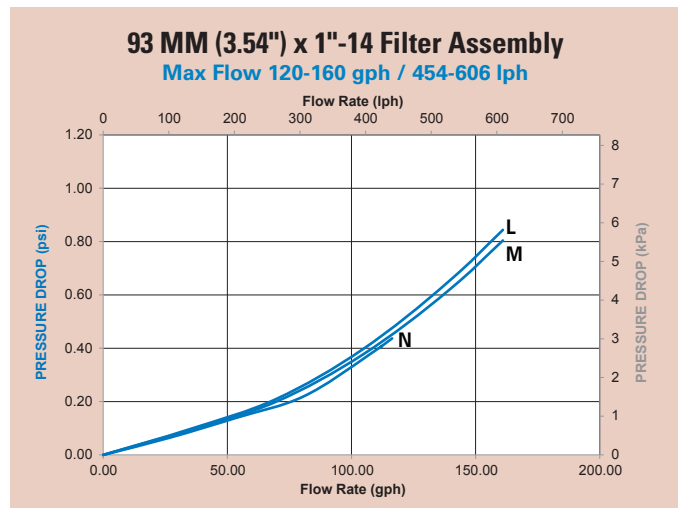
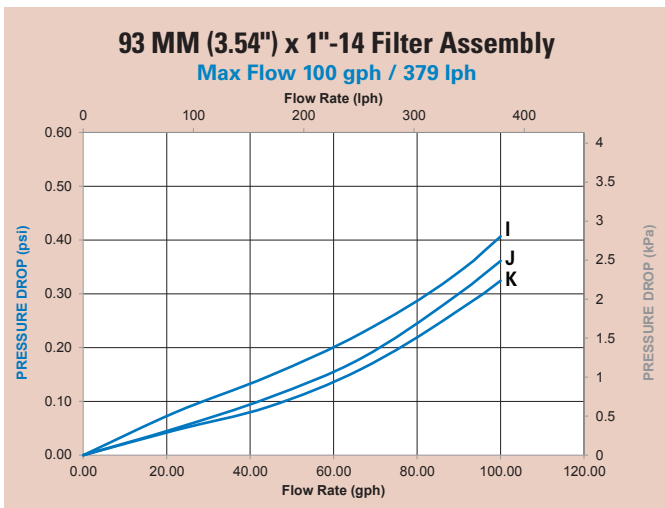
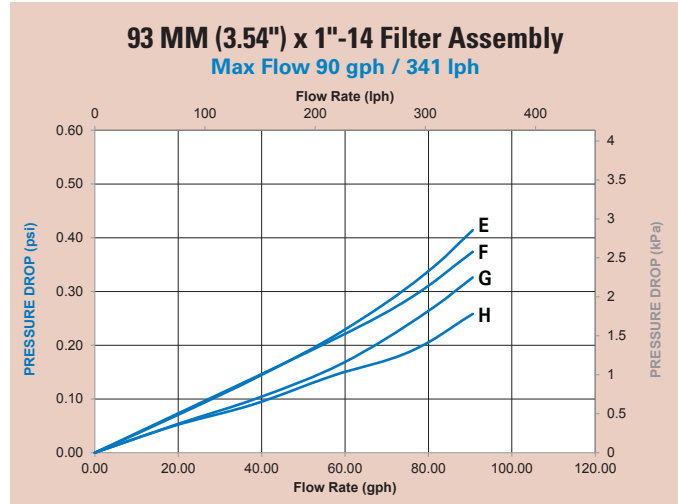
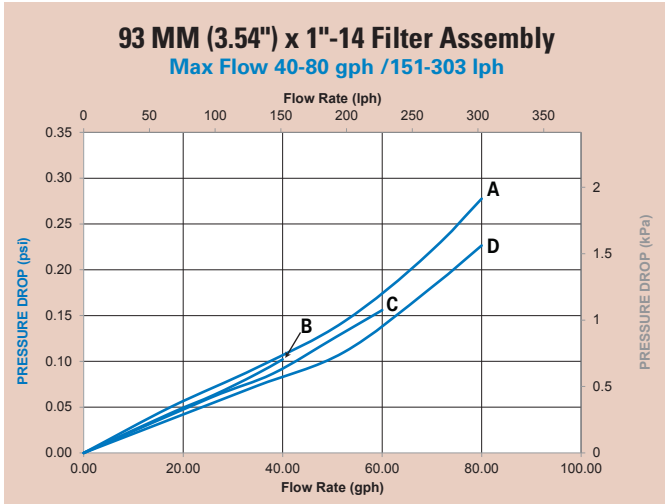



Flow Range: up to 180 gph / 681 lph

Operating Pressure
0-100 psi (690 kPa) without bowl

Temperature Range
-40° to 250°F (-40° to 121°C)

Flow Rate
Up to 180 gph / 681 lph
See table for filter flow rates

Fuel Compatibility
#1 or #2 Diesel, Kerosene, Biodiesel up to B20 and JP8

Mounting
Engine or Chassis

Water Removal @ Recommended Flow Rate
SAE J1488 Emulsified: 95% efficiency
SAE J1839 Free Water: 95% efficiency

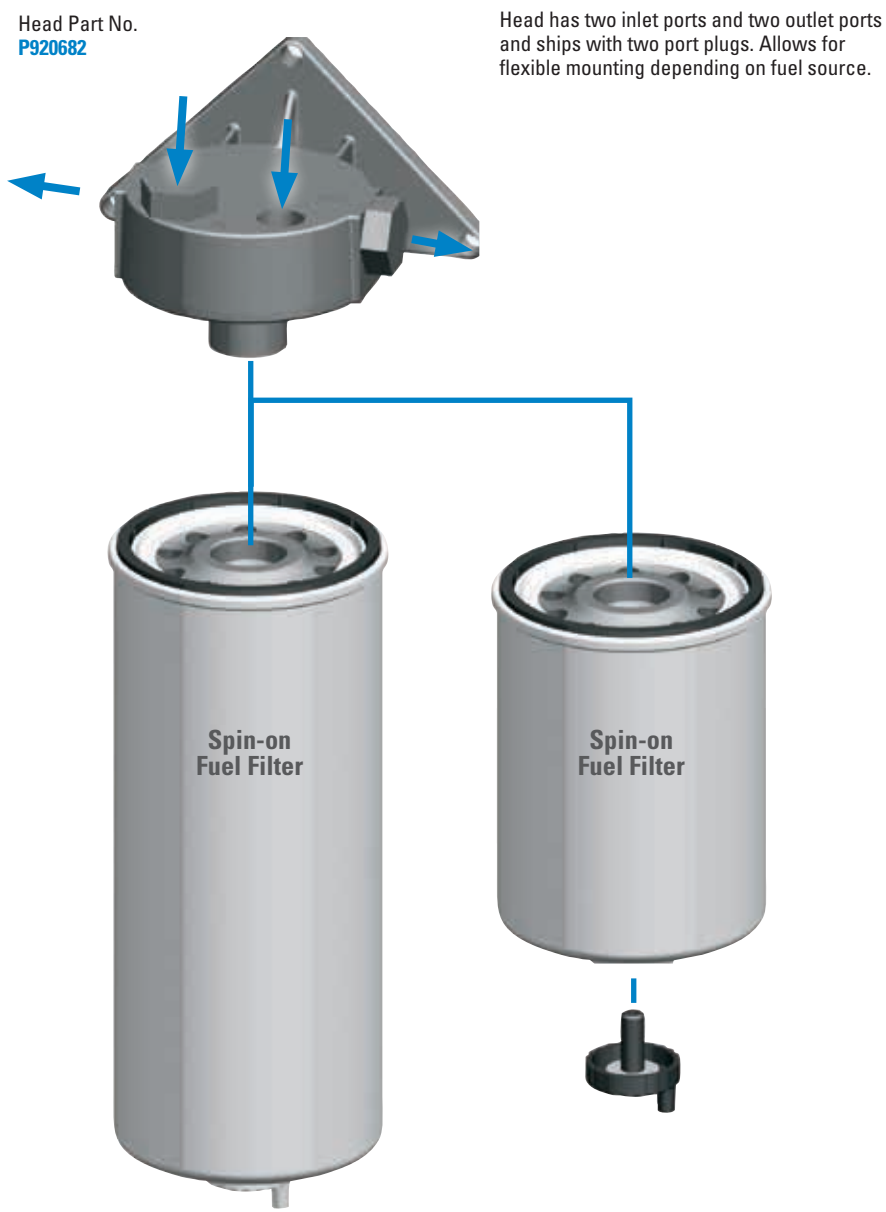



Specification Illustrations

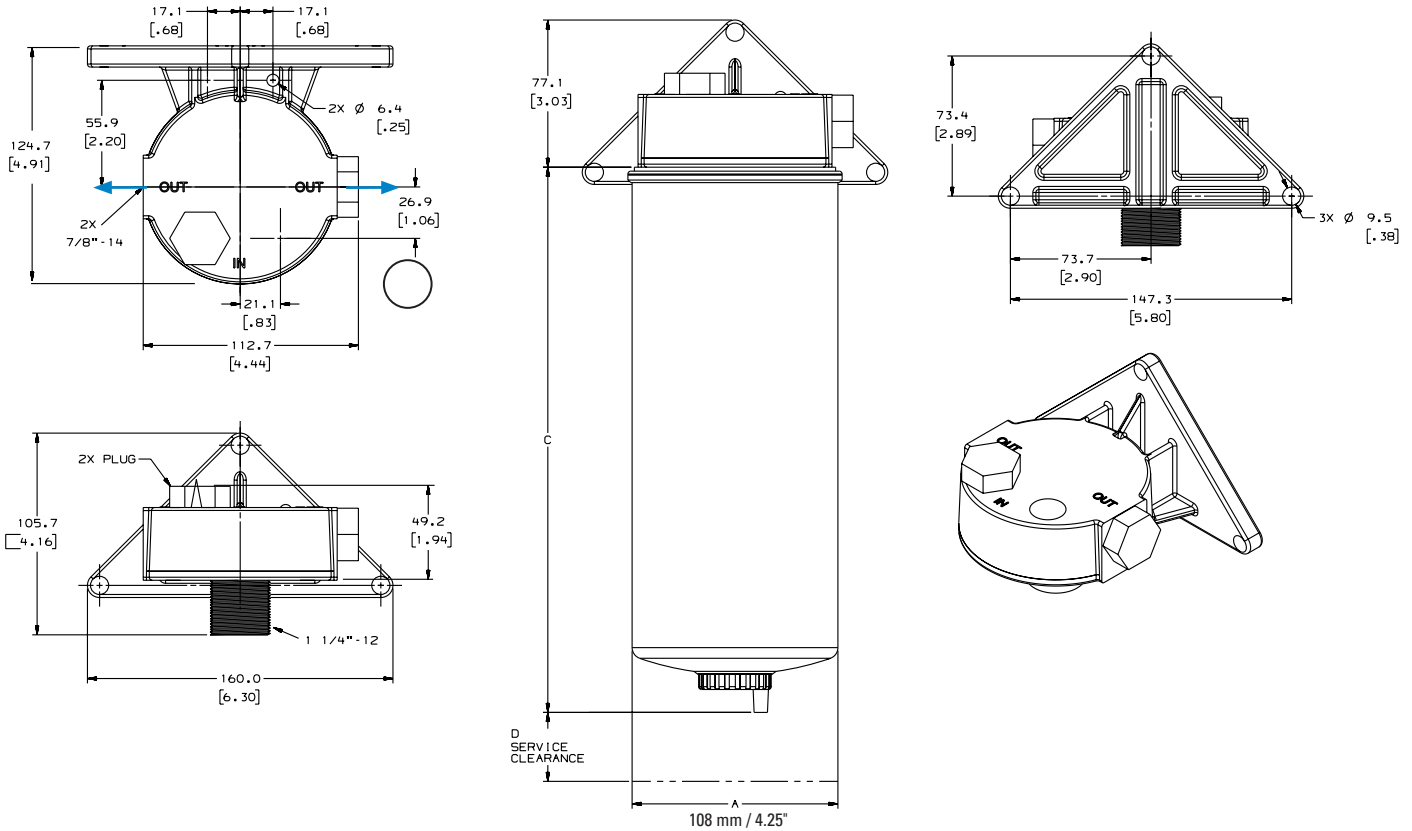

Filter Selection Chart

Filter Style	Max. Recommended Flow Rate		(C) Filter Length*		Media Type	Efficiency @ Micron	Stand Tube	Part Number	Performance Curve	(D) Service Clearance	
	gph	lph	in	mm						in	mm
 Standard Drain	60	227	7.44	189	Treated Cellulose	99% @ 15	No	P920711	A	1.03	26
	180	681	11.75	298	Treated Cellulose	99% @ 15	No	P920683	B		

Performance Curves

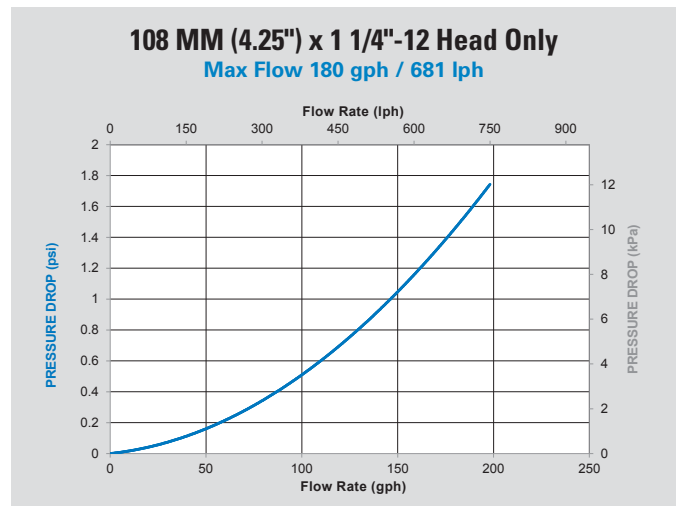
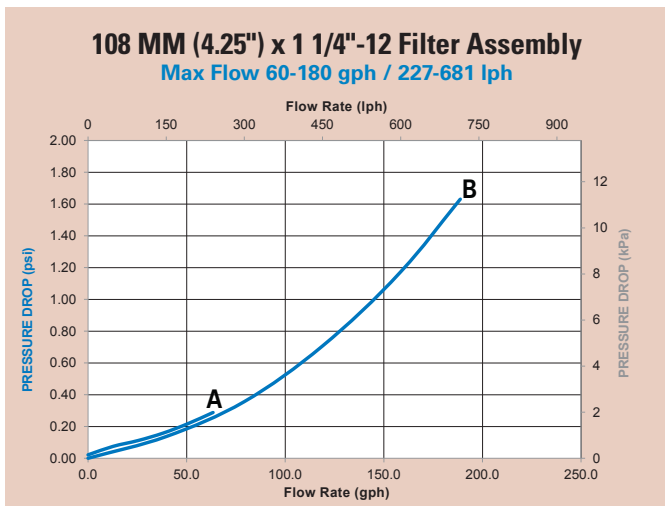



Flow Range: up to 250 gph / 946 lph

Operating Pressure

0-100 psi (690 kPa) without bowl

Temperature Range

-40° to 250°F (-40° to 121°C)

Flow Rate

Up to 230 gph / 946 lph
See table for filter flow rates

Fuel Compatibility

#1 or #2 Diesel, Kerosene, Biodiesel up to B20 and JP8

Mounting

Engine or Chassis

Water Removal @ Recommended Flow Rate

SAE J1488 Emulsified: 95% efficiency
SAE J1839 Free Water: 95% efficiency

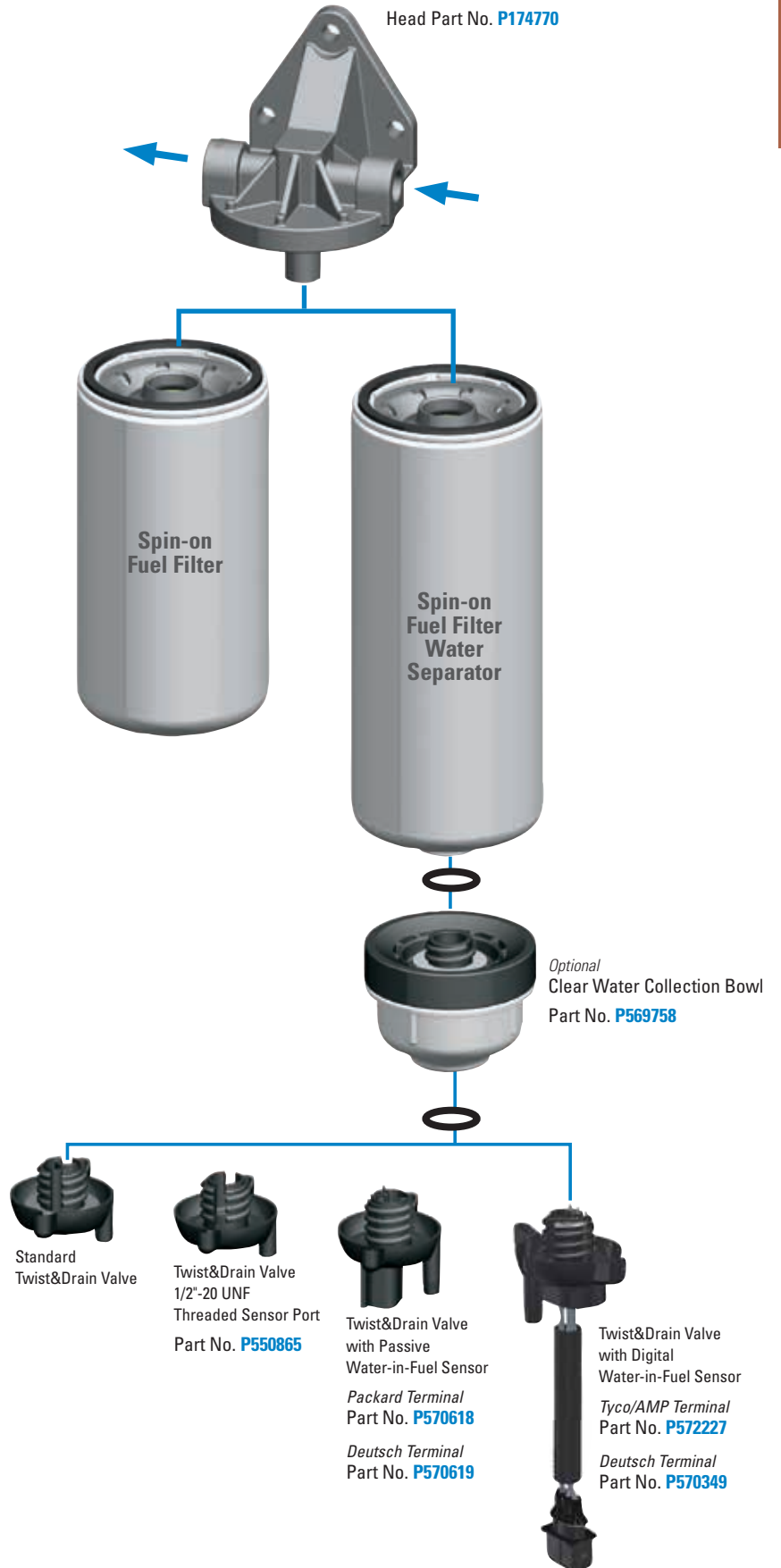



Fuel Filtration

Filter Dia. 118 MM (4.65") x 1 1/4"-12



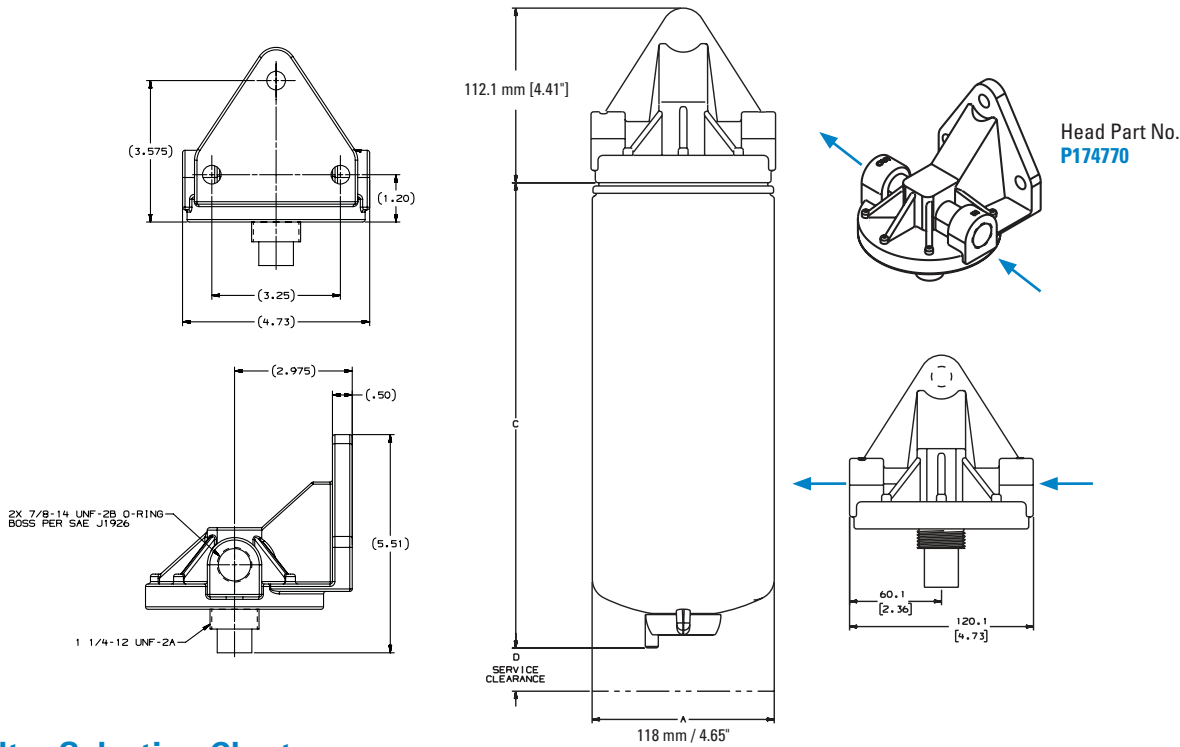

FUEL FILTRATION

Specification Illustrations



Filter Selection Chart

Filter Style	Max. Recommended Flow Rate		(C) Filter Length*		Media Type	Efficiency @ Micron	Stand Tube	Part Number	Performance Curve	(D) Service Clearance	
	gph	lph	in	mm						in	mm
Standard Drain 	205	776	12.24	311	Treated Cellulose	99% @ 25	No	P552216	B	1.57	40
					Synteq	99% @ 9	No	P550937			
					Synteq	99% @ 10	Yes	P552006			
No Drain 	250	946	8.94	227	Cellulose	99% @ 30	No	P550958	A		
			10.24	260	Cellulose	99% @ 9	No	P550202			

* Water Collection Bowl (part no. P569758) adds 1.98" / 50 mm to filter length.

Performance Curves

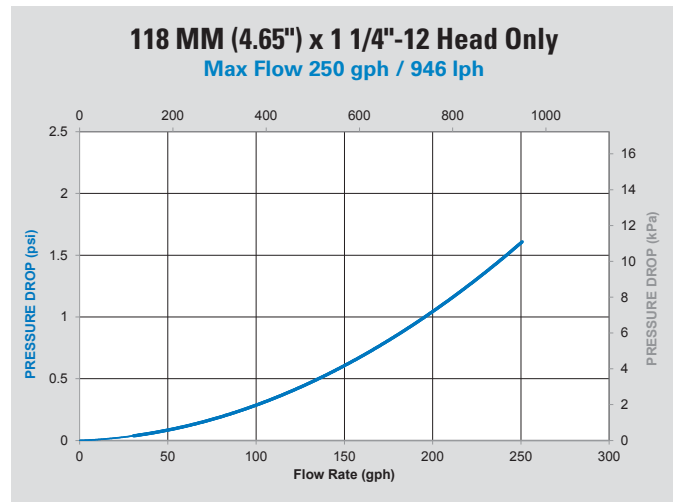
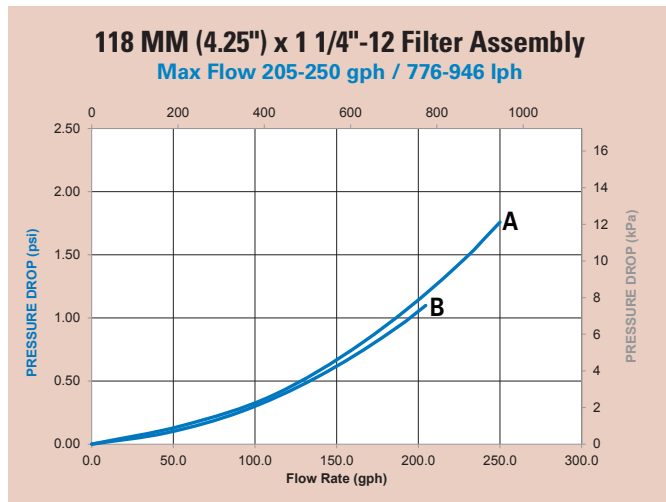



Flow Range: up to 250 gph / 946 lph

Operating Pressure

0-100 psi (690 kPa) without bowl

Temperature Range

-40° to 250°F (-40° to 121°C)

Flow Rate

Up to 250 gph / 946 lph
See table for filter flow rates

Fuel Compatibility

#1 or #2 Diesel, Kerosene, Biodiesel up to B20 and JP8

Mounting

Engine or Chassis





Specification Illustrations

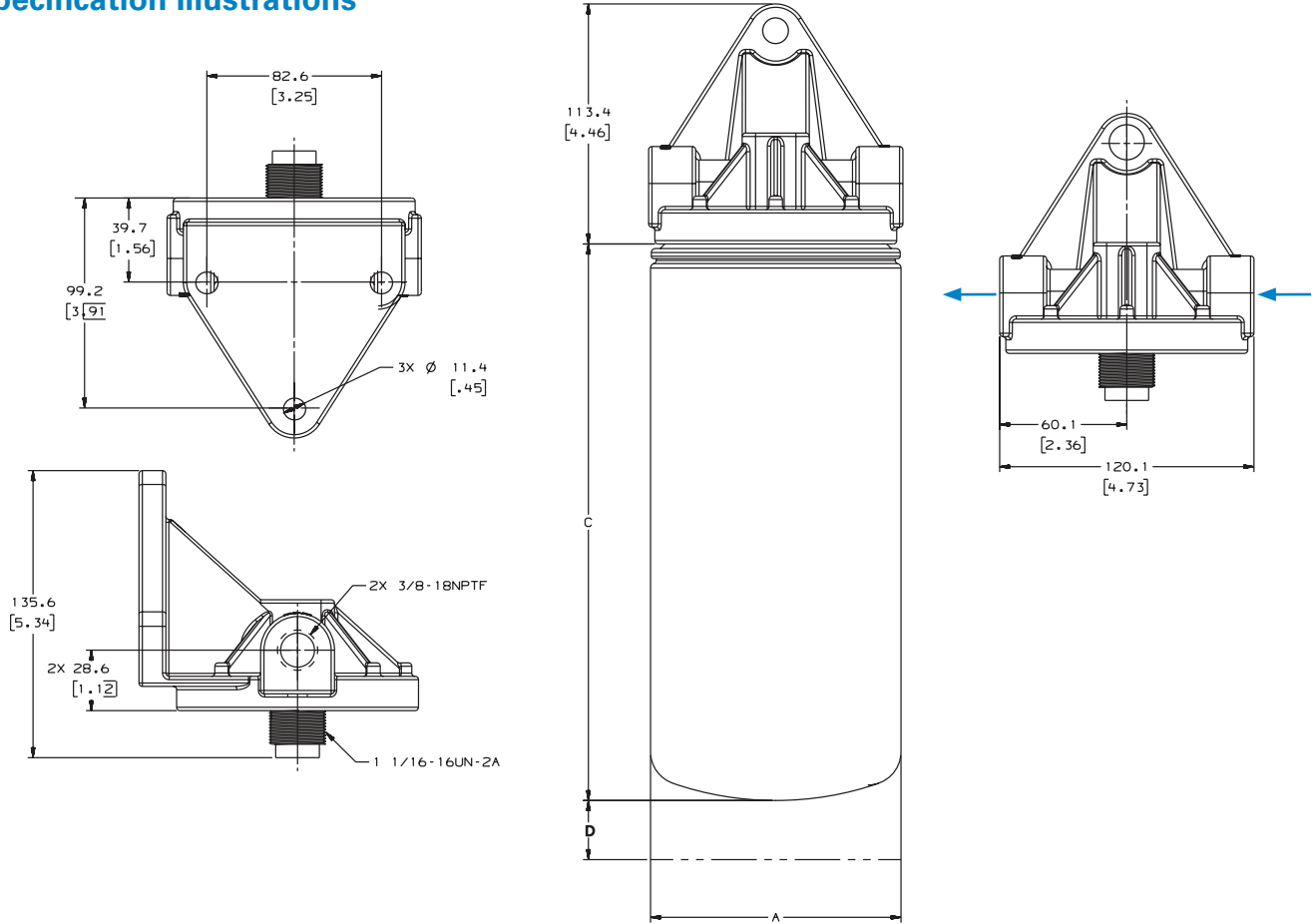

Filter Selection Chart

Filter Style	Max. Recommended Flow Rate		(C) Filter Length		Media Type	Efficiency @ Micron	Stand Tube	Part Number	Performance Curve	(D) Service Clearance	
	gph	lph	in	mm						in	mm
	250	946	8.94	227	Synteq	99% @ 5	No	EFF0047	A	1.14	29
					Cellulose	99% @ 16	No	P550959			

Performance Curves

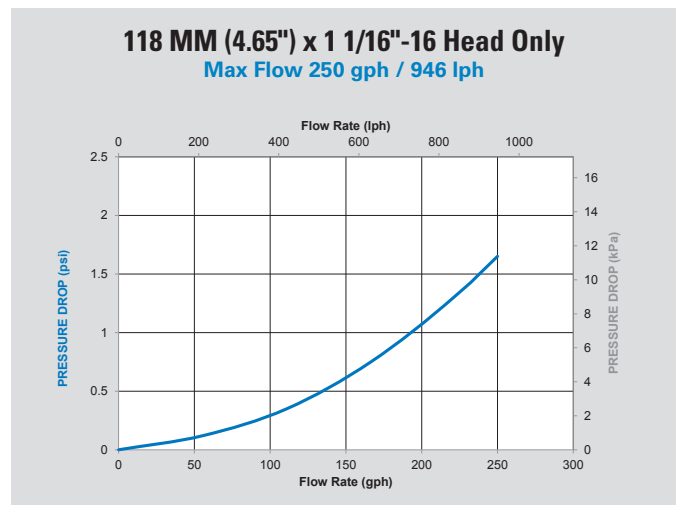
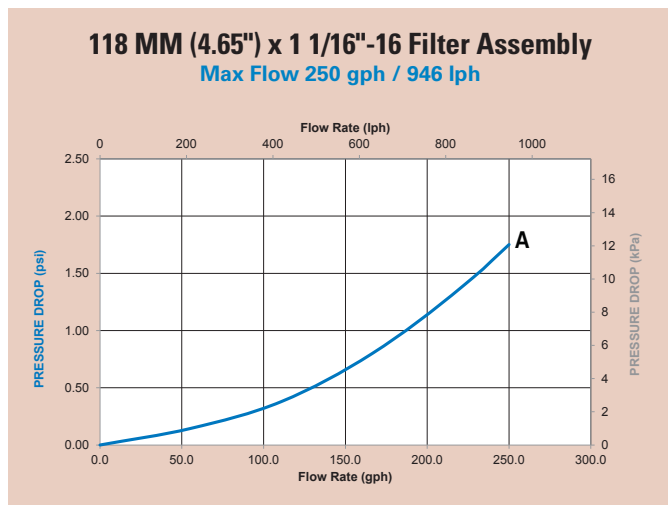

Water Drain Valves, Sensors & Bowl

For water drain flexibility, Donaldson Twist&Drain™ spin-on filters have a connection that can accommodate multiple drain valve types and a clear water collection bowl (80ml capacity). All Twist&Drain filters ship with a specific drain valve and one seal. When purchasing a water collection bowl, one seal will be included. Drain valves can be ordered separately and will include a replacement seal. The water collection bowl is a separate add-on component.

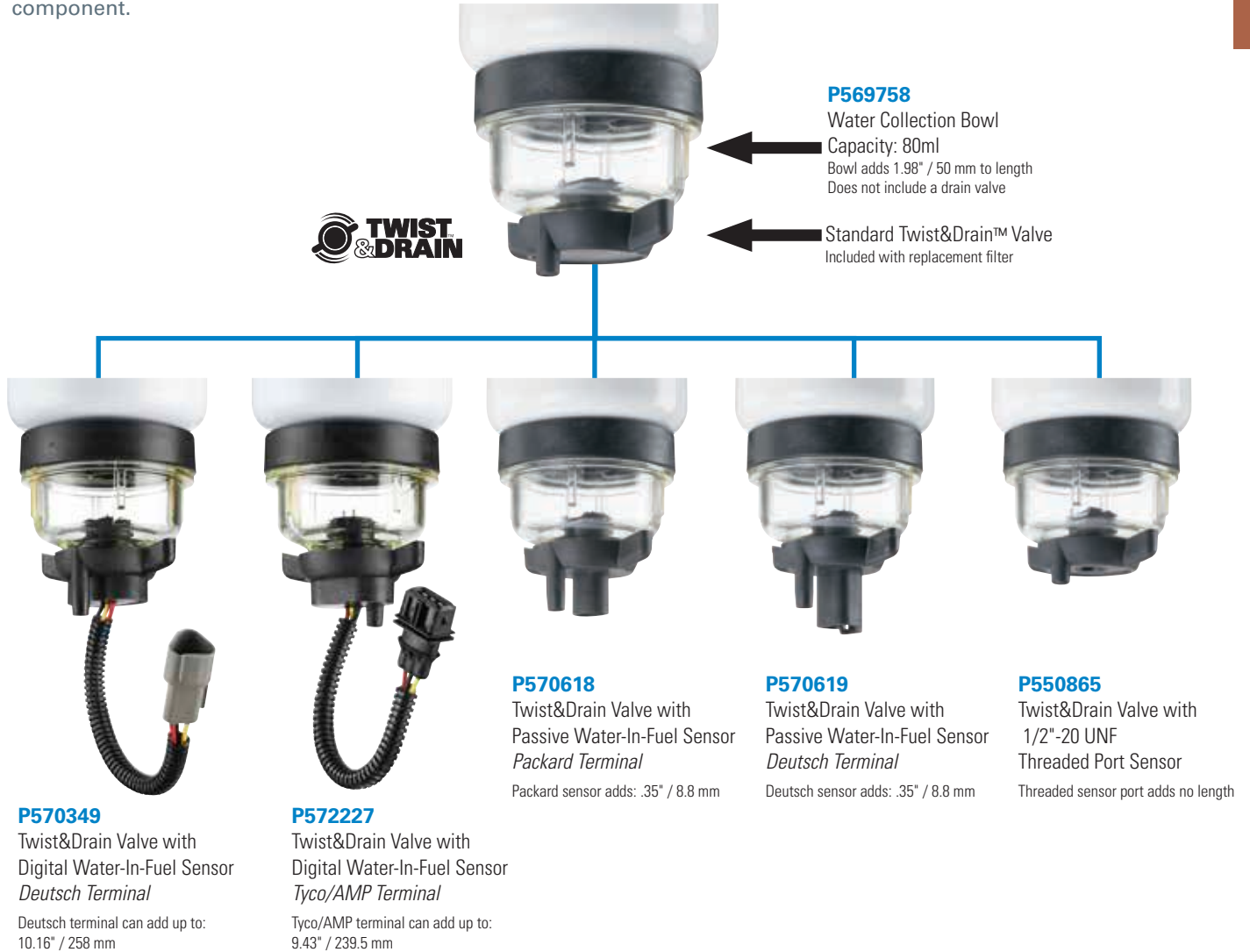

P569758
Water Collection Bowl
Capacity: 80ml
Bowl adds 1.98" / 50 mm to length
Does not include a drain valve

Standard Twist&Drain™ Valve
Included with replacement filter

P570349
Twist&Drain Valve with Digital Water-In-Fuel Sensor
Deutsch Terminal
Deutsch terminal can add up to: 10.16" / 258 mm

P572227
Twist&Drain Valve with Digital Water-In-Fuel Sensor
Tyco/AMP Terminal
Tyco/AMP terminal can add up to: 9.43" / 239.5 mm

P570618
Twist&Drain Valve with Passive Water-In-Fuel Sensor
Packard Terminal
Packard sensor adds: .35" / 8.8 mm

P570619
Twist&Drain Valve with Passive Water-In-Fuel Sensor
Deutsch Terminal
Deutsch sensor adds: .35" / 8.8 mm

P550865
Twist&Drain Valve with 1/2"-20 UNF Threaded Port Sensor
Threaded sensor port adds no length

Installation Torque for Twist&Drain™ [M24 X 5] Threads

Component		TIGHTENING TORQUE	
		LB-FT (in-lbs)	NEWTON-METERS (N-M)
Twist&Drain Valve <i>with or without WIF sensor</i>	With external lube applied	3.3 ± 0.8 (40 ± 9.6)	4.5 ± 1.1
	Without external lube applied	4.2 ± 0.8 (50.4 ± 9.6)	5.7 ± 1.1
Water Collection Bowl		6.0 ± 0.9 (72 ± 10.8)	(8.1 ± 1.2)

Seal Replacement

- 1 Push seal down onto thread stem.
- 2 Ensure seal is fully seated.

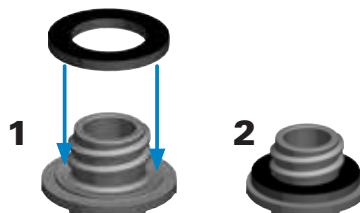

Replacement Seals



If seals show signs of wear or deterioration they should be replaced. The placement of the seals are between the threaded connections of the filter, water collection bowl, and Twist&Drain valve. When purchasing a water collection bowl or a Twist&Drain valve, one seal will be included.

P570771

Replacement seal kits are available in packages of 12.



O.D. 1.38" / 35 mm
ID: .86" / 22 mm
Thickness: .13" / 3.2mm



Water & Draining Fuel Filters

Most primary fuel filters have drains that allow the operator to drain the water that has been separated by the filter. The frequency with which the primary fuel filter needs to be drained is ultimately dependent on the quality of fuel that is being used. Most OEMs recommend draining your water separator daily. It is also recommended to pay attention to how much water is removed at each drain and adjust the frequency of servicing accordingly.

Why Remove Water in Fuel?

Water in fuel can prematurely wear and oxidize the steel components within the fuel injectors, leading to:

- Rusting and corrosion of components
- Governor/metering component failure
- Sticky metering components (both pump and nozzle)
- Injection component wear and seizure

Free or emulsified water must be removed from the fuel to prevent corrosion and damage to the fuel system. Fuel additives may claim they remove water, when really they dissolve the water. Which in turn, will pass through the filter and enter fuel injectors.

Types of water contamination in diesel fuel:

- 1) Emulsified water: water suspended in the fuel
- 2) Free water: water separated from the fuel and generally collected at the bottom of the fuel or the fuel storage tank
- 3) Dissolved water: water chemically dissolved in the fuel

Maintenance Recommendations & Guidelines

- Drain water from your primary filter daily when refueling
- Carry a spare set of fuel filters in case you receive a “bad” load of fuel
- Never switch to more open filter to get longer filter life, you are trading away fuel pump and injector life
- Never use fuel to lube the gasket. Fuel isn’t as slick as oil and if you use fuel it could cause gaskets to bunch or pinch when it is tightened, causing the filter to leak.
- If using biodiesel:
 - make sure your fuel supplier meets current fuel standards
 - make sure your engine is compatible with the concentration (or percent) biodiesel you wish to use
- When using your own fuel storage tank, remember that removing contaminants before they reach the vehicle is the best practice. Ensure you have effective bulk storage tank filtration.

Water-in-Fuel Sensors (WIFs)

Water-In-Fuel (WIF) sensors are typically chosen and installed by the engine manufacturer.

The WIF sensors connect to the fuel filter and route to a display on the dashboard. A WIF sends an electrical signal to the in-cab display and alerts the operator when water is in the fuel and should be drained from the filter. WIF sensors are more common in newer common rail injection systems.

During filter service, WIF sensors are disconnected and reused on the new filter. Sensors are likely to be replaced if connectors are damaged or wires are frayed.

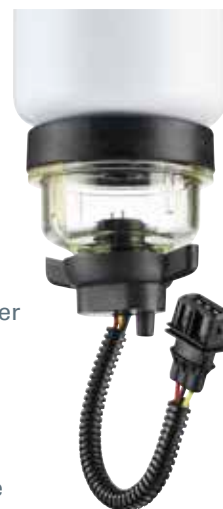

The most common WIF sensors are either Packard or Deutsch styles. Donaldson offers digital Tyco/AMP and Deutsch WIF sensors – as well as passive Packard or Deutsch WIF sensors that are integrated into the Twist&Drain valve.

Twist&Drain™ Icons Installation & Water Drain

Installation



Filter will indicate if you should fill with fuel before installation.



Apply a thin film of clean motor oil to the new gasket. Do not use grease.



Line up the filter threads to the threaded port carefully. Screw on and tighten until gasket makes contact with base.



For final tightening of the filter, turn the can to the number of turns (+) indicated on the can.



Reconnect the WIF sensor.

Water Draining

Three easy steps with standard drain valve.



Turn to open drain valve



Let water drain



Retighten drain valve



Spin-On Filters

Thread	OD		Length		Drain Type	Part No.	Part Description	Efficiency % @ Micron	Primary Application	GSKT O.D.		GSKT I.D.		Stand Tube
	IN	MM	IN	MM						IN	MM	IN	MM	
68 mm / 2.68" Diameter Family														
1-14	2.62	67	4.34	110	G	P551751	FUEL PRIMARY	50% @ 10	REPLACES WIX 24104	1.00	25	0.80	20	
76 mm / 3.00" Diameter Family														
7/8-14	3.05	77	5.83	148	G	P550368	FUEL PRIMARY	50% @ 5	NAVISTAR 1820749C1	5.05	128	4.71	120	
3/4-16	3.01	76	5.75	146	G	P550410	FUEL PRIMARY	99% @ 17	KOMATSU 600-311-8220	2.75	70	2.37	60	
	3.01	76	3.46	88	G	P553240	FUEL PRIMARY	99% @ 22	ISUZU 8-94414-796	2.50	64	2.16	55	
7/16-20	3.03	77	4.87	124	G	P550325	FUEL PRIMARY	50% @ 10	ONAN 122B325	3.02	77	1.75	44	
M16 x 1.5	2.99	76	4.72	120	G	P550526	FUEL PRIMARY	50% @ 10	VOLVO	2.81	71	2.48	63	
	3.02	77	2.49	63	G	P550678	FUEL PRIMARY	99% @ 25	FORD E6HZ9365B	2.81	71	2.48	63	
	3.02	77	3.26	83	G	P555095	FUEL PRIMARY	99% @ 9	FORD #E67HZ9365A (BRAZILIAN CAB FORWARD)	2.75	70	2.37	60	
	3.02	77	3.26	83	G	P550345	FUEL PRIMARY	99% @ 16	DEUTZ 1174424, MANN WK712/2	2.83	72	2.40	61	
	3.02	77	4.01	102	A	P551039	FUEL/WATER SEPARATOR	99% @ 20	BOBCAT 6667352, CNH 86504140 T&D VALVE	2.75	70	2.40	61	
	3.03	77	4.40	112	E	P550690	FUEL/WATER SEPARATOR	99% @ 25	CASE J911213	2.83	72	2.46	62	
	3.03	77	4.51	115	E	P550249	FUEL/WATER SEPARATOR	99% @ 25	CUMMINS 3912104	2.81	71	2.48	63	
	3.02	77	4.72	120	G	P550943	FUEL SECONDARY	99% @ 9	GMC 6.2L 25011214	2.75	70	2.37	60	
	3.04	77	4.72	120	G	P553004	FUEL PRIMARY	99% @ 16	VOLVO 243004	2.76	70	2.38	60	Yes
	3.02	77	4.72	120	G	P550440	FUEL SECONDARY	99% @ 16	CUMMINS 6C, 6CT SERIES	2.75	70	2.37	60	Yes
	3.02	77	5.81	148	A	P550588	FUEL/WATER SEPARATOR	99% @ 11	BOSCH 1457434056	2.76	70	2.40	61	
	3.02	77	5.81	148	A	P550248	FUEL/WATER SEPARATOR	99% @ 15	CUMMINS 3903202	2.82	72	2.46	62	Yes
	3.00	76	6.50	165	E	P550587	FUEL/WATER SEPARATOR	99% @ 25	DEUTZ 2133558, 2133943	2.75	70	2.37	60	
	3.37	86	3.37	86	E	P552374	FUEL/WATER SEPARATOR	50% @ 25	ONAN 149-2106; TORO 63-8300	2.74	70	2.37	60	
M16 x 1.5	3.02	77	5.81	148	A	P551615	FUEL/WATER SEPARATOR	99% @ 3	LOW FLOW ON AND OFF HIGHWAY	2.76	70	2.40	61	
M18 x 1.5	3.00	76	2.37	60	E	P551768	FUEL/WATER SEPARATOR	50% @ 15	RACOR R12P	2.70	69	2.50	63	
M20 x 1.5	3.00	76	3.40	86	G	P550127	FUEL PRIMARY	99% @ 17	KUBOTA 70000-43081	2.70	69	2.33	59	
80 mm / 3.15" Diameter Family														
1-14	3.18	81	6.09	176	G	P551740	FUEL PRIMARY	99% @ 9	CATERPILLAR 1R-0740	2.91	74	2.52	64	
7/8-14	3.15	80	6.93	176	G	P551315	FUEL PRIMARY	99% @ 3	CATERPILLAR 1R0759	2.89	74	2.50	64	
3/4-16	3.11	79	5.59	142	E	P550550	FUEL/WATER SEPARATOR	95% @ 20	KOMATSUP554477	2.76	70	2.48	63	
	3.15	80	3.31	84	G	P502177	FUEL PRIMARY	50% @ 10	FSA FF2028, RYCO Z169A	2.48	63	1.76	45	
	3.15	80	4.50	114	G	P502163	FUEL PRIMARY	50% @ 10	NISSAN 16403-Z9000, 16403-Z9005	2.50	64	2.11	54	
	3.15	80	6.89	175	G	P502167	FUEL PRIMARY	50% @ 10	NISSAN 16405-01T70	2.59	66	2.00	51	
	3.18	81	3.39	86	G	P550057	FUEL PRIMARY	99% @ 25	TOYOTA 23303-56301	2.52	64	2.13	54	
	3.31	84	3.94	100	G	P550225	FUEL SECONDARY	50% @ 10	HINO 23401-1332, NISSAN 16403Z9003	2.48	63	2.08	53	
M16 x 1.5	3.06	78	6.74	171	E	P550688	FUEL/WATER SEPARATOR	99% @ 25	DEUTZ	2.81	71	2.46	62	
	3.14	80	4.88	124	G	P550491	FUEL PRIMARY	50% @ 25	RVI, M&H WK727	2.80	71	2.44	62	
	3.15	80	5.98	152	F	P550498	FUEL/WATER SEPARATOR	50% @ 15	M & H WDK724	2.81	71	2.46	62	
	3.18	81	6.93	176	G	P550782	FUEL PRIMARY	99% @ 10	DAVCO 210 - M16 X 1.5 - 10 MICRON	2.81	71	2.52	64	
	3.18	81	6.93	176	G	P550783	FUEL PRIMARY	99% @ 25	DAVCO 210 - M16 X 1.5 - 25 MICRON	2.91	74	2.52	64	
M20 x 1.5	3.16	80	4.72	120	G	P502142	FUEL PRIMARY	50% @ 10	mitsubishi MB433425, TCM 20801-02131	3.06	78	2.48	63	
	3.15	80	3.93	100	G	P502143	FUEL PRIMARY	50% @ 10	MITSUBISHI 3446200300	2.76	70	2.52	64	

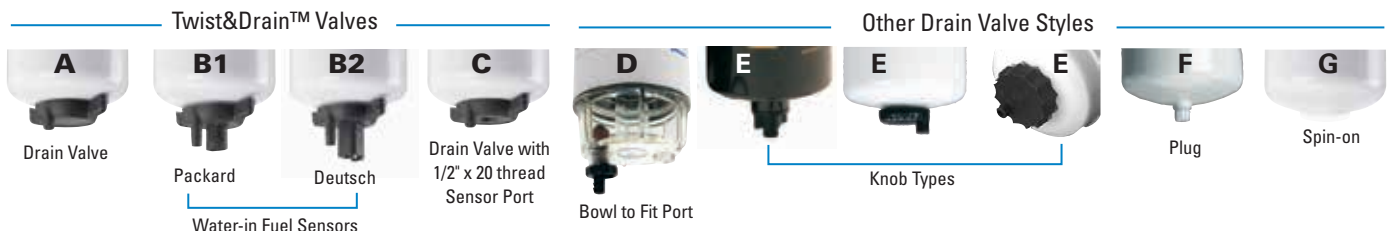



Spin-On Filters

Thread	OD		Length		Drain Type	Part No.	Part Description	Efficiency % @ Micron	Primary Application	GSKT O.D.		GSKT I.D.		Stand Tube
	IN	MM	IN	MM						IN	MM	IN	MM	
93 mm / 3.54" Diameter Family														
1-12	3.66	93	5.35	136	G	P550936	FUEL PRIMARY	99% @ 25	GMC 25011011, 8.2L	3.38	86	3.04	77	
	3.66	93	6.85	174	G	P554347	FUEL PRIMARY	99% @ 25	BULK FUEL W/O DRAIN	2.81	71	2.42	61	
	3.66	93	8.64	219	A	P553202	FUEL/WATER SEPARATOR	99% @ 35	RACOR S3202 T&D VALVE	3.39	86	3.05	78	
	3.66	93	8.64	219	c	P553212	FUEL/WATER SEPARATOR	99% @ 35	RACOR S3202 T&D INTEGRATED 1/2"-20 SENSOR PORT THD	3.39	86	3.05	78	
	3.69	94	5.37	136	G	P550115	FUEL PRIMARY	99% @ 45	FUEL DISPENSING PUMPS	2.84	72	2.47	63	
	3.69	94	5.37	136	G	P550215	FUEL PRIMARY	99% @ 22	WATER ABSORBING, FUEL DISPENSING PUMPS	2.84	72	2.46	62	
	3.69	94	7.44	189	F	P551915	FUEL PRIMARY	99% @ 22	BULK FUEL TANKS WITH SEDIMENT DRAIN	2.84	72	2.47	63	
	3.81	97	4.25	108	G	P550944	FUEL PRIMARY	50% @ 25	DETROIT DIESEL 8.2L ENG, FORD TRK & BUS	3.55	90	3.18	81	
	3.81	97	6.08	154	G	P550944	FUEL PRIMARY	99% @ 38	GMC 6.2L 25011285	3.55	90	3.18	81	
	3.81	97	7.36	187	A	P558010	FUEL/WATER SEPARATOR	99% @ 20	DETROIT DIESEL 23512317 T&D VALVE	3.55	90	3.18	81	
1-14	3.81	97	7.97	202	G	P556915	FUEL PRIMARY	99% @ 25	DET. DIESEL 23517471, AC T915D	3.38	86	3.04	77	
	3.66	93	5.35	136	G	P550105	FUEL PRIMARY	99% @ 25	CUMMINS 154709	2.81	71	2.42	61	
	3.66	93	5.35	136	G	P552251	FUEL PRIMARY	99% @ 17	IHC 702250C1	2.81	71	2.42	61	
	3.66	93	6.11	155	A	P550828	FUEL/WATER SEPARATOR	99% @ 140	CUMMINS ENGINES	2.83	72	2.44	62	
	3.68	93	6.85	174	G	P551178	FUEL PRIMARY	50% @ 10	NISSAN FL40399008	2.85	72	2.47	63	
	3.66	93	6.85	174	G	P553854	FUEL PRIMARY	99% @ 25	CARRIER, IHC, THERMOKING 11.3854	2.81	71	2.42	61	
	3.66	93	6.85	174	G	P557440	FUEL PRIMARY	99% @ 9	CATERPILLAR 1R-0711, 1P-2299, 6L-7440, KTSU 600-311-8290	2.81	71	2.42	61	
	3.68	93	6.95	177	G	P551313	FUEL SECONDARY	99% @ 3	CATERPILLAR 1R-0750	2.83	72	2.46	62	
	3.66	93	7.40	188	A	P558000	FUEL/WATER SEPARATOR	99% @ 20	CUMMINS 3308638 T&D VALVE	2.81	71	2.42	61	
	3.66	93	7.61	193	A	P553203	FUEL/WATER SEPARATOR	99% @ 3	RACOR S3203 T&D VALVE	2.83	72	2.44	62	
	3.66	93	7.61	193	A	P553205	FUEL/WATER SEPARATOR	99% @ 7	CATERPILLAR ENGINES T&D VALVE	3.39	86	3.05	78	
	3.66	93	7.61	193	C	P553213	FUEL/WATER SEPARATOR	99% @ 3	RACOR S3203 T&D INTEGRATED 1/2"-20 SENSOR PORT THD	2.83	72	2.44	62	
	3.66	93	7.61	193	C	P553215	FUEL/WATER SEPARATOR	99% @ 7	CATERPILLAR ENGINES T&D INTEGRATED 1/2"-20 SENSOR PORT THD	3.39	86	3.05	78	
	3.66	93	7.87	200	C	P555627	FUEL PRIMARY	99% @ 9	IHC 625627C1	2.81	71	2.42	61	
	3.68	93	7.98	203	A	P551001	FUEL/WATER SEPARATOR	99% @ 10	CUMMINS CELECT & QUANTUM ENGINE APPLICATIONS T&D VALVE	2.83	72	2.46	62	Yes
	3.66	93	8.40	213	B2	P550848	FUEL/WATER SEPARATOR	99% @ 10	CUMMINS ENGINES T&D INTEGRATED WIF	2.83	72	2.44	62	
	3.66	93	8.64	219	A	P553201	FUEL/WATER SEPARATOR	99% @ 10	RACOR S3201 T&D VALVE	2.83	72	2.44	62	
	3.66	93	8.64	219	A	P553204	FUEL/WATER SEPARATOR	99% @ 35	ALLIANCE ABPN12232FRT04 T&D VALVE	2.83	72	2.44	62	
	3.66	93	8.64	219	A	P553207	FUEL/WATER SEPARATOR	99% @ 3	ALLIANCE ABPN12232FRT03 T&D VALVE	2.83	72	2.44	62	
	3.66	93	8.64	219	C	P553211	FUEL/WATER SEPARATOR	99% @ 10	RACOR S3201 T&D INTEGRATED 1/2"-20 SENSOR PORT THD	2.83	72	2.44	62	
3.66	93	8.64	219	C	P553214	FUEL/WATER SEPARATOR	99% @ 35	ALLIANCE ABPN12232FRT04 T&D INTEGRATED 1/2"-20 SENSOR PORT THD	2.83	72	2.44	62		
3.66	93	8.64	219	C	P553217	FUEL/WATER SEPARATOR	99% @ 33	ALLIANCE ABPN12232FRT03 T&D INTEGRATED 1/2"-20 SENSOR PORT THD	2.83	72	2.44	62		
3.66	93	9.17	233	G	P551319	FUEL PRIMARY	99% @ <4	CATERPILLAR ENGINES	N/A	N/A	2.44	62		
3.66	93	9.22	234	Spec	P552032	FUEL/WATER SEPARATOR	99% @ 10	CUMMINS ISC, ISM ENGINES - CONTAINS DRAIN AND SENSOR PORT	2.81	72	2.42	62		
3.68	93	9.43	240	G	P551311	FUEL PRIMARY	99% @ 3	CATERPILLAR 1R-0749	2.83	72	2.46	62		
3.66	93	9.92	252	A	P551000	FUEL/WATER SEPARATOR	99% @ 10	CUMMINS CELECT & QUANTUM ENGINE APPLICATIONS T&D VALVE	2.81	71	2.42	61	Yes	
3.66	93	9.92	252	A	P550901	FUEL/WATER SEPARATOR	99% @ 7	CUMMINS ENGINES T&D VALVE	2.81	71	2.46	63		



Thread	OD		Length		Drain Type	Part No.	Part Description	Efficiency % @ Micron	Primary Application	GSKT O.D.		GSKT I.D.		Stand Tube
	IN	MM	IN	MM						IN	MM	IN	MM	
1-14	3.69	94	5.52	140	E	P551744	FUEL/WATER SEPARATOR	50% @ 10	RACOR R24S	3.43	87	3.11	79	
	3.69	94	5.68	144	F	P550108	FUEL PRIMARY	50% @ 25	JOHN DEERE AR45098, AR45097	2.84	72	2.47	63	
	3.69	94	5.85	149	E	P550691	FUEL/WATER SEPARATOR	99% @ 25	CUMMINS 3843447	2.83	72	2.46	62	
	3.69	94	7.38	187	A	P550847	FUEL/WATER SEPARATOR	99% @ 10	CATERPILLAR 1752949	2.81	71	2.45	62	
	3.69	94	8.69	221	G	P552253	FUEL SECONDARY	99% @ 15	IHC 702253C1	2.84	72	2.47	63	
	3.69	94	9.38	238	B1	P551122	FUEL/WATER SEPARATOR	99% @ 10	CUMMINS ENGINES T&D INTEGRATED WIF	2.83	72	2.46	62	Yes
	3.69	94	9.71	247	B2	P551103	FUEL/WATER SEPARATOR	99% @ 10	CUMMINS ENGINES T&D INTEGRATED WIF	3.69	94	2.83	72	Yes
	3.70	94	10.75	273	G	P550625	FUEL PRIMARY	99% @ 3	CATERPILLAR 1R0762	3.60	91	3.03	77	
	3.75	95	4.12	105	Bowl Thd	P550088	FUEL/WATER SEPARATOR	50% @ 10	FORD 6.6L & 7.8L ENG #E7HZ-4N184A, RACOR R26P	2.81	72	2.42	62	
	3.72	95	5.78	147	G	P552203	FUEL PRIMARY	95% @ 140	CUMMINS 4010476, FLEETGUARD FF2203	2.83	72	2.46	62	
	3.72	95	9.43	240	G	P551712	FUEL PRIMARY	99% @ 9	CATERPILLAR 1R-0712	2.81	71	2.42	61	
	3.79	96	6.22	158	E	P550553	FUEL/WATER SEPARATOR	99% @ 40	1999 FORD LIGHT TRUCK, MOTOR-CRAFT FD4597	3.59	91	3.15	80	
	3.81	97	4.22	107	G	P550104	FUEL PRIMARY	99% @ 25	CUMMINS 138627	2.81	71	2.42	61	
	3.81	97	5.70	145	G	P550109	FUEL PRIMARY	50% @ 10	FORD D3HE9176AA	3.56	90	3.17	81	
	3.81	97	7.40	188	F	P550106	FUEL PRIMARY	99% @ 25	CUMMINS D156172, 202893, FURN GSKT-P169192	2.81	71	2.42	61	
	3.82	97	7.88	200	G	P551004	FUEL PRIMARY	99% @ 5	PACCAR 1655115	2.76	70	2.48	63	
7/8-14	3.66	93	6.85	174	G	P550774	FUEL PRIMARY	99% @ 3	CUMMINS 3959612, ISC, ISL ISM ENGINES	2.83	72	2.44	62	
	3.66	93	6.85	174	G	P550879	FUEL PRIMARY	99% @ 5	CUMMINS 4940647	2.83	72	2.44	62	
	3.68	93	9.43	240	G	P551312	FUEL PRIMARY	99% @ 3	CATERPILLAR 1R-0753	2.83	72	2.46	62	
	3.78	96	8.70	221	G	P553855	FUEL SECONDARY	99% @ 20	IHC, THERMOKING 11.3855	2.84	72	2.46	62	
	3.81	97	5.22	133	G	P553693	FUEL SECONDARY	99% @ 20	CARRIER, THERMOKING 11.3693	2.82	72	2.42	61	
3/4-16	3.66	93	5.19	132	G	P552405	FUEL PRIMARY	50% @ 10	NISSAN 1640305D00, FL40305D00	2.83	72	2.46	63	
	3.71	94	4.92	125	G	P552564	FUEL PRIMARY	50% @ 10	ISUZU 1-13240-074-0, HITACHI 4206080	2.48	63	1.74	44	
	3.70	94	5.43	138	Spec	P550385	FUEL PRIMARY	50% @ 10	TOYOTA 2330364010	2.48	63	2.20	56	
	3.85	98	5.47	139	G	P551351	FUEL PRIMARY	50% @ 10	NISSAN 1640505E01	2.89	74	2.00	51	
1 1/2-16	3.78	96	7.35	187	Spec	P550735	FUEL PRIMARY	99% @ 25	NATURAL GAS FUELED CUMMINS ENGINES	3.47	88	2.99	76	
1 3/8-12	3.67	93	7.50	190	G	P551752	FUEL/WATER SEPARATOR	99% @ 40	AMACO A08	2.73	69	2.42	61	
13/16-12	3.66	93	4.21	107	G	P550928	FUEL SECONDARY	99% @ 16	GMC 25010959	3.38	86	3.04	77	
	3.66	93	6.85	174	G	EFF7917	FUEL SECONDARY	99% @ 5	DETROIT DIESEL 23530645	3.39	86	3.05	77	
	3.66	93	6.85	174	G	P556916	FUEL SECONDARY	99% @ 9	DET. DIESEL 23518530, AC TP916D	3.39	86	3.05	77	
	3.66	93	6.85	174	G	P556917	FUEL SECONDARY	99% @ 3	DETROIT DIESEL 23533726	3.39	86	3.05	77	
13/16-18	3.66	93	5.67	144	G	P558712	FUEL PRIMARY	99% @ 40	CASE IH A58712	2.81	71	2.42	61	
	3.76	96	6.01	153	A	P551329	FUEL/WATER SEPARATOR	99% @ 13	CASE, CUMMINS T&D VALVE	2.85	72	2.46	62	
	3.81	97	4.50	114	G	P550868	FUEL PRIMARY	99% @ 28	CASE A39868, DAVID BROWN	2.81	71	2.46	62	
15/16-16	3.66	93	5.55	141	G	P559100	FUEL PRIMARY	99% @ 23	CAT 9L-9100, 9L-8794	2.75	70	2.42	61	
	3.70	94	8.42	214	F	P552432	FUEL/WATER SEPARATOR	99% @ 25	ALLIS CHALMERS 4321716, 4321716-5	2.83	72	2.46	63	
	3.81	97	4.75	121	G	P550110	FUEL SECONDARY	99% @ 8	CASE A39867	2.82	72	2.42	61	
	3.81	97	5.61	142	G	P551127	FUEL SECONDARY	99% @ 12	CASE A58713	2.85	72	2.46	62	
M12 x 1.5	3.50	89	8.16	207	G	P550473	FUEL PRIMARY	50% @ 25	MERCEDES-BENZ 10922201, 10922301	2.80	71	2.44	62	
M14 x 1.5	3.82	97	7.60	193	G	P550665	FUEL/WATER SEPARATOR	50% @ 20	IVECO 1907539 / NEW HOLLAND 1931061	2.85	72	2.46	62	

Twist&Drain™ Valves

Other Drain Valve Styles





Spin-On Filters

Thread	OD		Length		Drain Type	Part No.	Part Description	Efficiency % @ Micron	Primary Application	GSKT O.D.		GSKT I.D.		Stand Tube
	IN	MM	IN	MM						IN	MM	IN	MM	
93 mm / 3.54" Diameter Family, continued														
M16 x 1.5	3.77	96	5.66	144	G	P550494	FUEL PRIMARY	50% @ 5	DAF 1318695	2.80	71	2.44	62	
	3.78	96	5.66	144	G	P550496	FUEL PRIMARY	50% @ 10	RENAULT VI. 5010359706	2.80	71	2.44	62	
	3.77	96	8.34	211	G	P550472	FUEL PRIMARY	50% @ 3	DAF 1328177	2.80	71	2.44	62	
	3.82	97	5.47	139	G	P554620	FUEL PRIMARY	99% @ 9	DEUTZ 1174422	2.81	71	2.42	61	
	3.82	97	8.27	210	G	P559624	FUEL PRIMARY	50% @ 5	DAF 247138	2.80	71	2.44	62	
	3.68	93	4.25	108	G	P550662	FUEL PRIMARY	99% @ 9	VOLVO CONSTRUCTION EQUIPMENT, 11708555	2.77	70	9	9	
M18 x 1.5	3.71	94	8.13	207	G	P550372	FUEL PRIMARY	99% @ 5	VOLVO 420799	2.81	71	2.46	62	
	3.78	96	5.59	142	G	P550004	FUEL PRIMARY	50% @ 10	RENAULT	2.80	71	2.44	62	
M20 x 1.5	3.68	93	3.94	100	G	P550049	FUEL PRIMARY	99% @ 30	MITSUBISHI ME016823	2.54	65	2.28	58	
	3.66	93	6.30	160	G	P550643	FUEL PRIMARY	99% @ 10	YANMAR SV SERIE; VOLVO EC/EW SERIES; VOLVO EC55B; VOLVO ECR AND ECR88	2.72	69	2.32	59	
	3.66	93	6.85	174	G	P550880	FUEL PRIMARY	99% @ 5	CASE 87803200, CUMMINS 4897897	2.83	72	2.44	62	
	3.66	93	6.85	174	G	P550881	FUEL PRIMARY	99% @ 5	CUMMINS 4897833, IVECO 2992241, DAF 1399760	2.83	72	2.44	62	
	3.66	93	7.96	202	B1	P550929	FUEL/WATER SEPARATOR	99% @ 5	CUMMINS 3991498 TIER 2 QSB & 2VE ENGINES	2.84	72	2.42	62	
	3.66	94	4.21	107	G	P550932	FUEL PRIMARY	99% @ 30	MITSUBISHI ME035393, ME035829	3.43	87	2.42	62	
	3.66	93	5.50	140	Bowl Thd	P550930	FUEL/WATER SEPARATOR		CUMMINS 3942533	2.83	72	2.44	62	
	3.69	94	5.75	146	Bowl Thd	P550930	FUEL/WATER SEPARATOR	99% @ 10	CUMMINS 3942533	2.73	69	2.46	63	
	3.74	95	3.15	80	G	P550048	FUEL PRIMARY	99% @ 30	MITSUBISHI ME006066	2.52	64	2.28	58	
	3.72	95	4.72	120	G	P502157	FUEL PRIMARY	50% @ 10	MAZDA	2.81	71	1.97	50	
	3.72	95	5.17	131	G	P502158	FUEL PRIMARY	50% @ 10	MAZDA 145623570A	3.62	92	2.81	71	
	3.78	96	4.65	118	Bowl Thd	P550931	FUEL/WATER SEPARATOR	95% @ 20	DODGE LIGHT TRUCK WITH CUMMINS DIESEL	2.83	72	2.46	62	
	3.90	99	5.43	138	G	P502149	FUEL PRIMARY	50% @ 10	DAIHATSU 2330387308000	2.81	71	2.19	56	
3.90	99	5.43	138	G	P550390	FUEL PRIMARY	50% @ 10	MITSUBISHI MB220900	2.87	73	2.20	56		
M24 x 1.5	3.66	93	6.77	172	G	P550391	FUEL PRIMARY	99% @ 30	MITSUBISHI ME056280	3.54	90	2.66	68	
	3.70	94	5.59	142	G	P550515	FUEL PRIMARY	85% @ 3-5	MANN & HUMMEL WK940/2, SCANIA 1411894	2.80	71	2.44	62	
	3.77	96	5.66	144	G	P550495	FUEL PRIMARY	50% @ 3	SAAB-SCANIA 1361685, 1372444	2.80	71	2.44	62	
	3.78	96	7.00	178	G	P550365	FUEL PRIMARY	99% @ 20	ROLLS ROYCE OE42873	2.84	72	2.46	63	
M72 x 2	3.58	91	9.00	228	G	P552200	FUEL SECONDARY	99% @ 8	CUMMINS 4088272, FLEETGUARD FF2200	3.74	95	3.10	79	

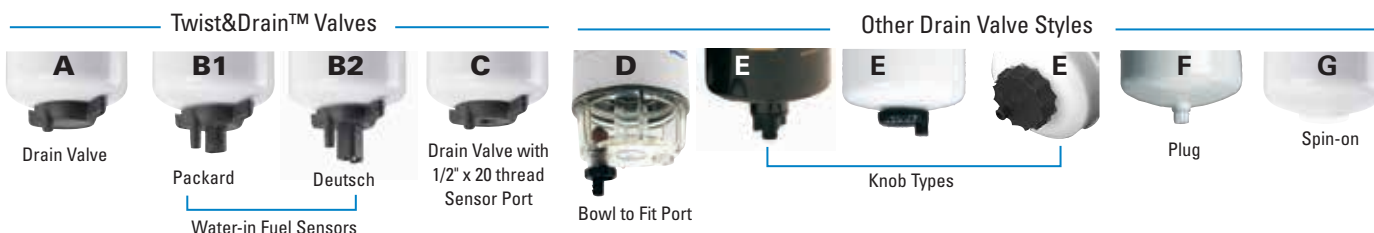



Thread	OD		Length		Drain Type	Part No.	Part Description	Efficiency % @ Micron	Primary Application	GSKT O.D.		GSKT I.D.		Stand Tube
	IN	MM	IN	MM						IN	MM	IN	MM	
108 mm / 4.25" Diameter Family														
1-12	4.24	108	8.90	226	G	P550753	FUEL PRIMARY	50% @ 10	JOHN DEERE RE519608	3.57	91	3.15	80	
	4.24	108	9.61	244	A	P551086	FUEL/WATER SEPARATOR	99% @ 12	DONALDSON TWIST&DRAIN	3.47	88	3.15	80	
	4.24	108	9.61	244	A	P551087	FUEL/WATER SEPARATOR	99% @ 15	DONALDSON TWIST&DRAIN	3.47	88	3.15	80	
	4.24	108	10.38	264	Spec	P550753	FUEL/WATER SEPARATOR	99% @ 5	JOHN DEERE RE509596, RE521818	4.00	102	3.56	90	
1-14	4.23	107	5.80	147	A	P551033	FUEL/WATER SEPARATOR	99% @ 9	RACOR R43, R50504	3.90	99	3.56	90	
	4.23	107	6.81	173	A	P551034	FUEL/WATER SEPARATOR	99% @ 9	RACOR S3226	3.90	99	3.56	90	
	4.23	107	5.80	147	A	P551055	FUEL/WATER SEPARATOR	99% @ 4	RACOR R60, S3225	3.51	89	3.17	81	
	4.23	107	5.80	147	A	P551056	FUEL/WATER SEPARATOR	99% @ 9	RACOR R60T	3.51	89	3.17	81	
	4.23	107	5.80	147	A	P551057	FUEL/WATER SEPARATOR	99% @ 25	RACOR R60P	3.51	89	3.17	81	
	4.23	107	3.82	173	A	P551065	FUEL/WATER SEPARATOR	99% @ 4	RACOR R90S, ALLIANCE	3.51	89	3.17	81	
	4.23	107	6.82	173	A	P551066	FUEL/WATER SEPARATOR	99% @ 9	RACOR R90T	3.51	89	3.17	81	
	4.23	107	6.82	173	A	P551067	FUEL/WATER SEPARATOR	99% @ 25	RACOR R90P	3.51	89	3.17	81	
	4.23	107	9.60	244	A	P551075	FUEL/WATER SEPARATOR	99% @ 4	RACOR R120S	3.51	89	3.17	81	
	4.23	107	9.60	245	A	P551025	FUEL/WATER SEPARATOR	99% @ 4	RACOR B32006	2.83	72	2.44	62	
	4.23	107	9.60	245	A	P551026	FUEL/WATER SEPARATOR	99% @ 9	MERCEDES 477130Z, VOLVO 11110668	3.90	99	3.56	90	
	4.23	107	9.60	244	A	P551076	FUEL/WATER SEPARATOR	99% @ 9	RACOR R120T	3.51	89	3.17	81	
	4.23	107	9.60	244	A	P551077	FUEL/WATER SEPARATOR	99% @ 25	RACOR R120P	3.51	89	3.17	81	
	4.23	107	9.78	248	A	P550900	FUEL/WATER SEPARATOR	99% @ 20	CATERPILLAR EQUIPMENT	3.86	98	3.55	90	Yes
	4.25	108	3.50	89	Bowl Thd	P550746	FUEL/WATER SEPARATOR	50% @ 3	RACOR R45 SERIES	3.77	96	3.50	89	
	4.26	108	5.79	147	E	P551056	FUEL/WATER SEPARATOR	50% @ 5	NAVISTAR 1685159C1	3.60	91	3.20	81	
	4.26	108	5.90	150	G	P559125	FUEL PRIMARY	99% @ 10	CARRIER 300109000	4.00	102	3.56	90	
	4.26	108	5.93	151	G	P550448	FUEL PRIMARY	99% @ 10	CARRIER 300109001	3.54	90	3.16	80	
	4.25	108	7.91	201	G	P551335	FUEL PRIMARY	99% @ 20	DAVCO 320120	3.98	101	3.58	91	
	4.25	108	10.31	262	G	EFF9092	FUEL PRIMARY	99% @ 5	CAT ENGINES	2.82	72	2.42	61	
4.25	108	11.88	302	Spec	P559122	FUEL/WATER SEPARATOR	99% @ 10	JOHN DEERE RE522687	4.00	102	3.56	90		
4.29	109	5.75	146	E	P551034	FUEL/WATER SEPARATOR	50% @ 12	NAVISTAR 1685159C91	3.97	101	3.59	91		
1-14	4.31	109	10.60	269	G	P555823	FUEL PRIMARY	99% @ 9	CAT 4N-5823	2.82	72	2.42	61	
	4.36	111	5.04	128	G	P550436	FUEL PRIMARY	50% @ 30	RACOR S3225P	4.00	102	3.56	90	
	4.36	111	5.05	128	Bowl Thd	P550729	FUEL/WATER SEPARATOR	50% @ 10	NAVISTAR 1677004C91	4.00	102	3.56	90	
	4.36	111	5.10	130	Bowl Thd	P550730	FUEL/WATER SEPARATOR	50% @ 10	FORD F1HZ9365A, CARRIER 30-01079	4.00	102	3.56	90	
	4.36	111	6.10	155	Bowl Thd	P550747	FUEL/WATER SEPARATOR	50% @ 10	RACOR R90 SERIES	3.77	96	3.50	89	
	4.38	111	8.21	209	E	P551767	FUEL/WATER SEPARATOR	99% @ 40	GM 23514654, JOHN DEERE 500186	3.77	96	3.50	89	
	4.38	111	8.50	216	Bowl Thd	P550748	FUEL/WATER SEPARATOR	50% @ 10	RACOR R120 SERIES	4.00	102	3.56	90	
	4.23	107	10.36	263	B2	P551010	FUEL/WATER SEPARATOR	99% @ 20	CATERPILLAR EQUIPMENT	3.86	98	3.55	90	Yes
	4.38	111	11.30	287	E	P551746	FUEL/WATER SEPARATOR	99% @ 5	CATERPILLAR 1335673	3.50	89	3.18	81	
	4.39	112	4.02	102	Bowl Thd	P553375	FUEL/WATER SEPARATOR	50% @ 10	FORD E8TZ-9N184-A	3.77	96	3.50	89	
	4.39	112	5.04	128	Bowl Thd	P550913	FUEL/WATER SEPARATOR	50% @ 30	MACK 21017305	N/A	N/A	N/A	N/A	
	7/8-14	4.23	107	4.23	107	A	P551027	FUEL/WATER SEPARATOR	99% @ 4	JOHN DEERE RE522688	3.90	99	3.56	90
4.23		107	9.6	244	A	P551031	FUEL/WATER SEPARATOR	99% @ 15	CASE 1808623C1	2.83	72	2.44	62	
4.24		108	6.74	171	E	P550669	FUEL/WATER SEPARATOR	99% @ 5	JOHN DEERE RE522688	3.93	100	3.55	90	
4.24		108	7.14	181	G	P551318	FUEL PRIMARY	99% @ 9	NAVISTAR 1822588C1	2.81	71	2.45	62	
4.28		109	4.60	117	G	P550811	FUEL SECONDARY	99% @ 10	FORD, IHC 6.9L 1804459C1	2.83	72	2.45	62	
4.28		109	7.98	203	G	P552603	FUEL SECONDARY	99% @ 9	IHC 672603C1	2.82	72	2.42	61	
3/4-16	4.29	109	7.20	183	G	P551605	FUEL PRIMARY	99% @ 3	IVECO 1901605	2.80	71	2.40	61	
7/8-16	4.28	109	7.89	200	G	P550218	FUEL SECONDARY	99% @ 17	MACK 483-GB-218B	2.82	72	2.42	61	
1 1/16-16	4.28	109	10.31	262	G	P550431	FUEL SECONDARY	99% @ 9	MACK 483-GB-431	3.89	99	3.55	90	
1 1/4-12	4.38	111	11.75	298	A	P920683	FUEL/WATER SEPARATOR	99% @ 15	3 GPM HIGH PERF FF/WS	4.32	110	3.85	98	
	4.38	111	7.44	189	A	P920711	FUEL/WATER SEPARATOR	99% @ 15	1 GPM HIGH PERF FF/WS	4.32	110	3.85	98	
13/16-18	4.23	107	9.60	244	A	P551030	FUEL/WATER SEPARATOR	99% @ 17	MACK 483GB465	2.83	72	2.44	62	
	4.28	109	7.89	200	G	P550219	FUEL PRIMARY	50% @ 14	MACK 483-GB-219A	2.82	72	2.42	61	



Spin-On Filters

Thread	OD		Length		Drain Type	Part No.	Part Description	Efficiency % @ Micron	Primary Application	GSKT O.D.		GSKT I.D.		Stand Tube
	IN	MM	IN	MM						IN	MM	IN	MM	
108 mm / 4.25" Diameter Family, continued														
15/16-16	4.26	108	8.96	228	F	P552475	FUEL/WATER SEPARATOR	50% @ 10	LUBER-FINER LFP2100C	2.81	71	2.46	62	
	4.28	109	10.31	262	F	P552370	FUEL/WATER SEPARATOR	50% @ 10	FORD E7HZ-9N184-B, E8HT-9J288-AA	2.85	72	2.48	63	
M22 x 1.5	4.23	107	9.6	244	A	P551028	FUEL/WATER SEPARATOR	99% @ 17	MACK 483GB472M	3.90	99	3.56	90	
	4.25	108	7.95	202	G	P554470	FUEL PRIMARY	99% @ 25	MACK 483-GB-470M	3.88	99	3.54	90	
	4.25	108	10.40	264	E	P554472	FUEL/WATER SEPARATOR	99% @ 25	MACK 483GB472M	3.98	101	3.58	91	
M30 x 1.5	4.23	107	7.95	202	G	P554476	FUEL SECONDARY	99% @ 9	MACK 483GB476M	3.90	99	3.54	90	
	4.23	107	9.6	244	A	P551029	FUEL/WATER SEPARATOR	99% @ 4	MACK 483GB477M	3.9	99	3.56	90	
	4.25	108	8.34	212	E	P554477	FUEL/WATER SEPARATOR	99% @ 5	MACK ASET	3.98	101	3.58	91	
	4.25	108	10.30	262	G	P554471	FUEL SECONDARY	99% @ 9	MACK 483GB471M	3.88	99	3.54	90	
M32 x 1.5	4.43	113	10.00	254	G	P550529	FUEL PRIMARY	99% @ 5	VOLVO 20430751	4.09	104	3.66	93	
	4.43	113	10.31	262	G	P554000	FUEL PRIMARY	99% @ 5	MTU ENGINE, MANN & HUMMEL WDK11102/10	4.09	104	3.66	93	
	4.25	108	10.24	260	G	P551021	FUEL PRIMARY	99% @ 5	MTU 0020922801, 002092801	4.06	103	3.66	93	
118 mm / 4.65" Diameter Family														
1 1/16-16	4.67	119	8.94	227	G	EFF0047	FUEL SECONDARY	99% @ 5	DETROIT DIESEL ENGINES	4.32	110	3.85	98	
	4.67	119	8.94	227	G	P550959	FUEL SECONDARY	99% @ 16	FORD, GMC 25011026	4.32	110	3.85	98	
1 1/4-12	4.67	119	8.94	227	G	P550958	FUEL PRIMARY	99% @ 30	DETROIT DIESEL 25011024	4.32	110	3.85	98	
	4.66	118	10.24	260	G	P550202	FUEL PRIMARY	99% @ 9	CUMMINS 299202	4.32	110	3.85	98	
	4.66	118	12.24	311	A	P552216	FUEL/WATER SEPARATOR	99% @ 17	CUMMINS 3309437	4.39	112	3.87	98	
	4.66	118	12.25	311	A	P550937	FUEL/WATER SEPARATOR	99% @ 9	KOMATSU	4.33	110	3.86	98	Yes
	4.74	120	12.32	313	A	P552006	FUEL/WATER SEPARATOR	99% @ 10	CUMMINS 3089916	4.39	112	3.87	98	
1 5/8-12	4.66	118	11.73	2.98	G	P553500	FUEL SECONDARY	99% @ 3	KOMATSU	4.33	110	3.86	98	
2 1/4-12	4.65	118	10.38	264	G	DBF5782	FUEL SECONDARY	99% @ 4	CUMMINS QSK19, QSK38, QSK50	4.68	119	4.00	102	
M90 x 2	4.65	118	8.80	224	G	P555776	FUEL SECONDARY	99% @ 5	CUMMINS ISX	4.69	119	4.02	102	
	4.65	118	11.68	297	G	P555686	FUEL SECONDARY	99% @ 5	CUMMINS ISX	4.69	119	4.02	102	
136 mm / 5.36" Diameter Family														
1 3/8-16	5.34	136	12.19	310	G	P551316	FUEL PRIMARY	99% @ 3	CATERPILLAR 1R-0755	4.28	109	3.90	99	
	5.38	137	11.77	299	F	P550348	FUEL/WATER SEPARATOR	99% @ 7	DETROIT DIESEL 23512631	4.29	109	3.92	100	
	5.38	137	12.13	308	G	P553080	FUEL PRIMARY	99% @ 9	CAT 8N-3080, 3500 SERIES ENGINE	4.31	109	3.92	100	
M39 x 1.5	5.35	136	12.05	306	G	P765199	FUEL PRIMARY	99% @ 10	MTU 0020922101	4.29	109	4.33	110	



I.D.	OD		Length		Part No.	Part Description	Efficiency @ Micron	Primary Application
	IN	MM	IN	MM				
Stanadyne FM100 System Fuel Filter Water Separators								
Stanadyne® is a registered trademark of Stanadyne Corporation								
.90	23	3.15	80	5.31	135	P551423	FUEL/WATER SEPARATOR-STANDARD FLOW	99% @ 10 CAT, JOHN DEERE
.90	23	3.15	80	5.31	135	P551426	PRIMARY- STANDARD FLOW	99% @ 20 AGCO, CAT, JCB
.90	23	3.15	80	5.31	135	P551429	PRIMARY- STANDARD FLOW	99% @ 50 AGCO, CAT, PERKINS
.90	23	3.15	80	5.31	135	P551436	PRIMARY- REVERSE FLOW	99% @ 50 CAT
.90	23	3.15	80	6.05	154	P551421	FUEL/WATER SEPARATOR-STANDARD FLOW	99% @ 3 IR, JOHN DEERE, LIEBHERR
.90	23	3.15	80	6.05	154	P551424	FUEL/WATER SEPARATOR-STANDARD FLOW	99% @ 10 JOHN DEER, PERKINS, CAT
.90	23	3.15	80	6.05	154	P551427	PRIMARY- STANDARD FLOW	99% @ 20 CAT, JOHN DEERE, JCB
.90	23	3.15	80	6.05	154	P551430	PRIMARY- STANDARD FLOW	99% @ 50 JOHN DEERE, LIEBHERR, NEW HOLLAND
.90	23	3.15	80	6.05	154	P551432	FUEL/WATER SEPARATOR-REVERSE FLOW	99% @ 10 CNH, PERKINS, FORD
.90	23	3.15	80	6.05	154	P551434	PRIMARY- REVERSE FLOW	99% @ 20 JOHN DEERE, LIEBHERR, CASE, JCB
.90	23	3.15	80	6.05	154	P551437	PRIMARY- REVERSE FLOW	99% @ 50 JOHN DEERE, NEW HOLLAND
.90	23	3.15	80	7.71	196	P551422	FUEL/WATER SEPARATOR - STANDARD FLOW	99% @ 3 JOHN DEERE, LIEBHERR
.90	23	3.15	80	7.71	196	P551425	FUEL/WATER SEPARATOR - STANDARD FLOW	99% @ 10 CAT, CNH, JCB



Cartridge Filters

I.D.		OD		Length		Part No.	Part Description	Efficiency @ Micron	Primary Application
IN	MM	IN	MM	IN	MM				
.90	23	3.15	80	7.71	196	P551428	PRIMARY- STANDARD FLOW	99% @ 20	JOHN DEERE
.90	23	3.15	80	7.71	196	P551431	PRIMARY- STANDARD FLOW	99% @ 50	JOHN DEERE, MACK, RVI
.90	23	3.15	80	7.71	196	P551433	FUEL/WATER SEPARATOR- REVERSE FLOW	99% @ 10	CNH, FORD, CAT
.90	23	3.15	80	7.71	196	P551435	PRIMARY- REVERSE FLOW	99% @ 20	JOHN DEERE, McCORMICK
Fuel Cartridge Filters									
0.20	5	0.70	18	2.01	51	P550559	FUEL PRIMARY		GM 5651921
0.26	7	2.19	56	1.47	37	P550364	FUEL PRIMARY		LISTER PETER 20113112
0.35	9	3.28	83	3.00	76	P505973	FUEL PRIMARY		TOYOTA HILUX
0.38	10	2.24	57	2.99	76	P552341	FUEL PRIMARY	99% @ 45	CAT 9M2341, FOR 9M2342 USE 2 P552341
0.43	11	1.38	35	2.44	62	P502134	FUEL PRIMARY	50% @ 16	YANMAR 10450055710
0.43	11	1.38	35	3.39	86	P502166	FUEL PRIMARY	50% @ 16	YANMAR 12455055700, KUBOTA 16271-43560
0.44	11	2.14	54	3.47	88	P550214	FUEL PRIMARY	99% @ 20	CLARK, GMC, IHC, AUTO, PICKUP
0.43	11	2.44	62	2.36	60	P550038	FUEL PRIMARY	99% @ 30	HINO 23401-1060
0.43	11	2.83	72	1.73	44	P502113	FUEL PRIMARY	99% @ 30	MITSUBISHI 3166201031
0.43	11	2.83	72	3.54	90	P550056	FUEL PRIMARY	99% @ 30	NISSAN 16444-29000
0.47	12	1.38	35	3.43	87	P502135	FUEL PRIMARY	50% @ 12	YANMAR 10599155710
0.47	12	1.38	35	3.81	97	P502133	FUEL PRIMARY	50% @ 12	YANMAR
0.49	12	1.42	36	3.54	90	P550645	FUEL PRIMARY		YANMAR 11974055600
0.46	12	2.87	73	3.14	80	P550745	FUEL PRIMARY		YANMAR 120324-55760
0.47	12	3.30	84	5.53	140	P550349	FUEL PRIMARY		MERCEDES, MANN BF900X (FELT)
0.47	12	3.30	84	5.50	140	P550861	FUEL PRIMARY	99% @ 9	DEUTZ, MERCEDES, ATLAS-COPCO, IHC
0.52	13	1.14	29	2.27	58	P552378	FUEL PRIMARY		FORD SBA360720020
0.51	13	1.14	29	3.35	85	P502138	FUEL PRIMARY	50% @ 12	KUBOTA 15231-43563, 15231-43560
0.50	13	1.39	35	1.88	48	P550007	FUEL PRIMARY	99% @ 22	IHC, DODGE, FORD, JEEP, MELROE
0.51	13	1.87	47	1.77	45	P551769	FUEL PRIMARY		ISUZU 5878101970
0.53	13	2.22	56	4.49	114	P550860	FUEL PRIMARY		DEUTZ 1160033 (FELT)
0.52	13	2.75	70	4.52	115	P550481	FUEL PRIMARY		CLAAS, HANOMAG, LIEBHERR, MERCEDES, VOLVO
0.53	13	3.30	84	5.30	135	P550061	FUEL PRIMARY		DEUTZ 1168469
0.52	13	3.36	85	5.70	145	P550489	FUEL PRIMARY		CLAAS, DEMAG, LIEBHERR, MERCEDES
0.50	13	3.81	97	2.85	72	P550437	FUEL PRIMARY	95% @ 5	MOTORCRAFT FD4596, FORD F81Z-9N184-AA
0.55	14	2.60	66	4.30	109	P550060	FUEL PRIMARY	99% @ 9	DEUTZ, ATLAS COPCO (PLEATED PAPER)
0.55	14	4.86	123	3.55	90	P551081	FUEL PRIMARY	95% @ 5	FORD LIGHT TRUCK, INCLUDES SERVICE LID
0.55	14	4.86	123	4.54	115	P551082	FUEL PRIMARY	95% @ 5	FORD LIGHT TRUCK, INCLUDES SERVICE LID
0.56	14	3.56	90	3.99	101	P550966	FUEL/WATER SEPARATOR	50% @ 7	FORD NAVISTAR LIGHT TRUCK
0.57	14	2.83	72	3.35	85	P552563	FUEL PRIMARY	50% @ 20	ISUZU 5-878100500
0.57	14	3.53	90	5.31	135	P550040	FUEL PRIMARY	50% @ 5	HITACHI 4514801, ISUZU 1878100270
0.57	14	3.54	90	5.52	140	P550044	FUEL PRIMARY	99% @ 30	MITSUBISHI 30062-65011
0.57	14	4.00	102	6.32	161	P550042	FUEL PRIMARY	99% @ 30	ISUZU 1878102070
0.59	15	2.80	71	3.93	100	P550039	FUEL PRIMARY		HITACHI 4020429
0.58	15	2.93	74	2.91	74	P551339	FUEL PRIMARY	99% @ 30	TOYOTA 0423468010
0.58	15	3.33	84	2.88	73	P552470	FUEL PRIMARY		ALLIS CHALMERS 4512207-3 CATERPILLAR 666-3172; CHRYSLER J0936407; MASSEY FERGUSON 1069954-M91
0.53	13	3.30	84	5.30	135	P550061	FUEL PRIMARY		DEUTZ 1168469
0.52	13	3.36	85	5.70	145	P550489	FUEL PRIMARY		CLAAS, DEMAG, LIEBHERR, MERCEDES
0.50	13	3.81	97	2.85	72	P550437	FUEL PRIMARY	95% @ 5	MOTORCRAFT FD4596, FORD F81Z-9N184-AA
0.55	14	2.60	66	4.30	109	P550060	FUEL PRIMARY	99% @ 9	DEUTZ, ATLAS COPCO (PLEATED PAPER)
0.57	14	2.83	72	3.35	85	P552563	FUEL PRIMARY	50% @ 20	ISUZU 5-878100500
0.56	14	3.56	90	3.99	101	P550966	FUEL/WATER SEPARATOR	50% @ 7	FORD NAVISTAR LIGHT TRUCK
0.57	14	3.53	90	5.31	135	P550040	FUEL PRIMARY	50% @ 5	HITACHI 4514801, ISUZU 1878100270
0.59	15	3.58	91	5.43	138	P502116	FUEL PRIMARY	99% @ 30	MITSUBISHI ME971550, ME971553
0.59	15	3.60	91	6.38	162	P551338	FUEL PRIMARY	99% @ 30	NISSAN 1644429027
0.59	15	3.62	92	4.33	110	P550054	FUEL PRIMARY	99% @ 30	MITSUBISHI ME036478
0.59	15	3.61	92	5.28	134	P550055	FUEL PRIMARY	99% @ 30	NISSAN 16444-99128
0.59	15	3.62	92	5.31	135	P550023	FUEL PRIMARY	99% @ 30	NISSAN 16444-90127
0.59	15	4.09	104	4.09	104	P550392	FUEL PRIMARY	99% @ 30	HINO 234011090

Cartridge Filters

I.D.		OD		Length		Part No.	Part Description	Efficiency @ Micron	Primary Application
IN	MM	IN	MM	IN	MM				
Fuel Cartridge Filters									
0.59	15	4.37	111	5.51	140	P550028	FUEL PRIMARY	99% @ 30	NISSAN 16444-99028
0.62	16	2.59	66	4.47	114	P550120	FUEL PRIMARY	99% @ 20	MANN BF700X
0.62	16	2.93	74	2.20	56	P550673	FUEL PRIMARY	99% @ 25	IHC 478037C1
0.62	16	2.93	74	4.11	104	P550672	FUEL PRIMARY	99% @ 25	KOMATSU 600-311-8210
0.63	16	2.91	74	4.15	106	P550026	FUEL PRIMARY	99% @ 30	ISUZU 9-9885111940
0.63	16	2.95	75	2.60	66	P502118	FUEL PRIMARY	99% @ 30	TOYOTA 0423456010
0.63	16	3.50	89	6.42	163	P550366	FUEL/WATER SEPARATOR		FORD 844F9176CAB
0.63	16	3.54	90	2.73	69	P552014	FUEL/WATER SEPARATOR	50% @ 30	RACOR 2010PM
0.63	16	3.54	90	2.73	69	P552013	FUEL/WATER SEPARATOR	50% @ 2	RACOR 2010SM
0.65	17	4.31	109	6.47	164	P550447	FUEL/WATER SEPARATOR	99% @ 20	FLEETGUARD FS1011 FOR OPTIGUARD SYSTEM
0.70	18	1.45	37	3.82	97	P552395	FUEL PRIMARY		WHITE 163956AS
0.72	18	3.13	80	5.44	138	P552423	FUEL PRIMARY		SERVICE ELEMENT FOR GRAVITY FLOW SERVICE TANKS
0.69	18	4.52	115	8.10	206	P551624	FUEL SECONDARY	99% @ 30	AC TP624 W/PLEATED PAPER
0.75	19	2.95	75	6.97	177	P502196	FUEL PRIMARY	50% @ 20	ISUZU 13240045
0.75	19	3.37	86	4.12	105	P551748	FUEL PRIMARY		JOHN DEERE AR45678
0.74	19	3.41	87	2.80	71	P556245	FUEL PRIMARY	99% @ 14	CASE, JOHN DEERE, IHC, MF, ROOSAMASTER
0.75	19	3.44	87	3.41	87	P502169	FUEL PRIMARY	50% @ 10	LEYLAND ABU9642, MAZDA SL07-23570
0.75	19	3.50	89	2.76	70	P551168	FUEL PRIMARY		PERKINS 31938
0.75	19	3.50	89	2.80	71	P557111	FUEL PRIMARY		CAV FUEL SYSTEM APPLICATIONS
0.74	19	3.50	89	5.28	134	P550394	FUEL PRIMARY		MASSEY FERGUSON, PERKINS
0.73	19	3.62	92	5.51	140	P502114	FUEL PRIMARY	99% @ 30	mitsubishi ME046010
0.77	19	3.98	101	4.78	121	P552473	FUEL PRIMARY		ALLIS CHALMERS BM33761; CUMMINS BM33761; FORD EDL-9176-A; INTERNATIONAL 3054750-R91
0.75	19	4.23	107	4.34	110	P551310	FUEL/WATER SEPARATOR	99% @ 10	CHRYSLER 0488396AA
0.79	20	1.97	50	3.50	89	P502161	FUEL PRIMARY	50% @ 16	YANMAR 12910055650, KUBOTA 15521-43160
0.78	20	4.25	108	6.73	171	P502131	FUEL PRIMARY	50% @ 20	MANN B405C,
0.81	21	2.75	70	3.37	86	P551167	FUEL PRIMARY		CHRYSLER 5037896
0.81	21	4.33	110	4.60	117	P552044	FUEL/WATER SEPARATOR	50% @ 30	RACOR 2040PM
0.81	21	4.33	110	4.60	117	P552043	FUEL/WATER SEPARATOR	50% @ 2	RACOR 2040SM
0.81	21	4.67	119	9.60	244	P552024	FUEL/WATER SEPARATOR	50% @ 30	RACOR 2020PM
0.81	21	4.67	119	9.60	244	P552023	FUEL/WATER SEPARATOR	50% @ 2	RACOR 2020SM
0.82	21	3.41	87	4.10	104	P550800	FUEL/WATER SEPARATOR		DODGE LIGHT TRUCK, CHRYSLER 68001914AA
0.87	22	3.86	98	6.35	161	P502132	FUEL PRIMARY	99% @ 30	MANN EK405, P1018/1
0.87	22	4.64	118	8.39	213	P550125	FUEL PRIMARY	99% @ 20	CUMMINS 130909,299125
0.91	23	2.19	56	2.48	63	P550567	FUEL PRIMARY		PETTER 2032470
0.98	25	3.70	94	7.19	183	P550347	FUEL PRIMARY	99% @ 28	FIAT GEOTECH 1909107
0.97	25	5.00	127	9.75	248	P558600	FUEL PRIMARY		KOMATSU 6610-79-8600
0.98	25	5.83	148	8.07	205	P550316	FUEL/WATER SEPARATOR	99% @ 20	CAT, CUMMINS, GROVE
1.00	25	5.81	148	9.37	238	P550043	FUEL PRIMARY	99% @ 20	CUMMINS, HOUGH, MICH 139097, 256834
1.04	26	3.01	76	4.41	112	P550686	FUEL/WATER SEPARATOR	99% @ 25	FRAM CS1133PL SEPARATOR
1.02	26	3.00	76	6.00	152	P550522	FUEL SOCK	99% @ 40	GMC 21029
1.04	26	3.01	76	7.34	186	P550685	FUEL/WATER SEPARATOR	99% @ 25	FRAM CC1133PL COALESCER
1.03	26	2.98	76	7.81	198	P550540	FUEL SECONDARY	99% @ 22	CUMMINS, GMC 5573262
1.04	26	3.01	76	9.70	246	P551162	FUEL PRIMARY		CONTINENTAL 12395HE
1.02	26	4.33	110	7.91	201	P551337	FUEL PRIMARY	99% @ 30	NISSAN 1644497001
1.08	27	2.99	76	7.95	202	P550627	FUEL PRIMARY		MAN TGA
1.06	27	3.19	81	4.53	115	P550201	FUEL SECONDARY	99% @ 25	MACK 237-GB-28
1.07	27	3.74	95	3.72	95	P502226	FUEL PRIMARY	50% @ 20	ISUZU 1132401940
1.10	28	2.90	74	2.37	60	P550560	FUEL SOCK		CASE A35863, A36557
1.10	28	3.40	86	3.27	83	P553261	FUEL SECONDARY	99% @ 20	GMC 5573261
1.12	28	3.37	86	6.50	165	P558792	FUEL PRIMARY	99% @ 10	CAT 4H-8792, 9H-4729, 6H-5932
1.12	28	4.00	102	8.75	222	P550541	FUEL SOCK	99% @ 40	GMC 5574980
1.12	28	4.81	122	9.13	232	P550547	FUEL/WATER SEPARATOR	50% @ 30	CIMTEK EHS30, 300-07
1.12	28	4.81	122	9.13	232	P550607	FUEL/WATER SEPARATOR	50% @ 10	FUEL DISPENSING PUMPS



I.D.		OD		Length		Part No.	Part Description	Efficiency @ Micron	Primary Application
IN	MM	IN	MM	IN	MM				
1.24	31	2.95	75	8.38	213	P550552	FUEL SOCK		GMC 5575032
1.32	34	3.48	88	4.80	122	P550501	FUEL PRIMARY	99% @ 9	PUROLATOR F70100 HOUSING
1.50	38	3.35	85	7.11	180	P550628	FUEL PRIMARY		SCANIA 164 AND SCANIA MARINE ENGINES DI SERIES
1.53	39	3.46	88	4.45	113	P556287	FUEL PRIMARY		C.A.V. 7111/792
1.61	41	3.90	99	9.23	234	P551317	FUEL PRIMARY	99% @ 3	CATERPILLAR 1R-0756
1.62	41	3.93	100	9.25	235	P559850	FUEL PRIMARY	99% @ 22	CATERPILLAR 8N9850, 1R0718
1.73	44	1.38	35	0.45	11	P502115	FUEL PRIMARY	99% @ 30	MITSUBISHI MA125373
1.81	46	3.74	95	6.79	173	P785373	FUEL PRIMARY	99% @ 5	MAN TGL SERIES 51125030061
1.81	46	4.13	105	8.06	205	P550631	FUEL PRIMARY		CUMMINS 299631
2.22	56	2.40	61	1.97	50	P550404	FUEL PRIMARY	99% @ 30	TOYOTA 2330034100
2.46	62	5.50	140	10.00	254	P550032	FUEL SOCK	99% @ 40	DETROIT DIESEL
2.60	66	3.35	85	4.43	113	P550527	FUEL/WATER SEPARATOR		FORD 3C3Z9N184CA F SERIES PICKUP
2.73	69	3.27	83	5.23	133	P550352	FUEL/WATER SEPARATOR	50% @ 5	GM 10154635, 6.2L DIESEL
3.39	86	3.58	91	3.94	100	P550808	FUEL		MERCEDES 6460920501
6.47	164	4.62	117	0.65	17	P550752	FUEL/WATER SEPARATOR		Fleetguard FS19559
G 8-36	NA	1.12	28	2.72	69	P502136	FUEL PRIMARY		CAT 5S7645



DAVCO Fuel System Filters

DAVCO® and EleMax® are registered trademarks of DAVCO Technology, LLC.

0.66	17	3.45	88	4.44	113	P550460	FUEL/WATER SEPARATOR	99% @ 7	DAVCO 230/232 SERIES DETROIT DIESEL
0.66	17	3.82	97	6.74	171	P550463	FUEL/WATER SEPARATOR	98% @ 7	DAVCO 380/382 SERIES DETROIT DIESEL ENGINES
0.66	17	3.82	97	6.74	171	P550467	FUEL/WATER SEPARATOR	99% @ 7	DAVCO 380/382 SERIES ELEMEX FUEL PROCESSORS
0.66	17	3.82	97	7.00	178	P550736	FUEL/WATER SEPARATOR	98% @ 25	DAVCO 380/382 SERIES ELEMEX FUEL PROCESSORS
0.66	17	3.82	97	7.00	178	P550737	FUEL/WATER SEPARATOR	99% @ 50	DAVCO 380/382 SERIES ELEMEX FUEL PROCESSORS
0.66	17	3.82	97	7.00	178	P550757	FUEL PRIMARY	99% @ 16	DAVCO 230/232 SERIES DETROIT DIESEL
0.66	17	3.81	97	7.03	179	P551052	FUEL/WATER SEPARATOR	99% @ 10	DAVCO 380/382 and CUMMINS FH230 FUEL PRO
0.66	17	4.21	107	6.74	171	P550510	FUEL/WATER SEPARATOR	99% @ 7	DAVCO 102011, 102012
.66	17	4.21	107	7.04	179	P550849	FUEL/WATER SEPARATOR	98% @ 7	DAVCO PLUS SIZE ELEMEX 7 MICRON
.66	17	4.21	107	7.04	179	P550851	FUEL/WATER SEPARATOR	98% @ 25	DAVCO PLUS SIZE ELEMEX 25 MICRON
.66	17	4.21	107	7.04	179	P550853	FUEL/WATER SEPARATOR	99% @ 50	DAVCO PLUS SIZE ELEMEX 50 MICRON
1.04	26	5.83	148	7.61	193	P551011	FUEL/WATER SEPARATOR	98% @ 7	DAVCO 482 SERIES 7 MICRON



Metal-Free Fuel Filters

NA	NA	3.54	90	6.22	158	P550908	FUEL PRIMARY		CHRYSLER 68061633AA, CUMMINS 5257769
0.55	14	3.74	95	7.97	202	P550762	FUEL PRIMARY	99% @ 15	MERCEDES 5410900151
0.83	21	3.39	86	4.09	104	P550785	FUEL/WATER SEPARATOR	99% @ 10	CHRYSLER 5015581AD
0.82	21	3.74	95	5.59	142	P550657	FUEL/WATER SEPARATOR	99% @ 7	IH DT466 2004 ON
1.06	27	3.62	92	3.98	101	P550632	FUEL PRIMARY	99% @ 8	MERCEDES 0000901551



Racor Turbine System Filters

Racor® is a registered trademark of Parker Hannifin Corporation

0.50	13	1.78	45	2.68	68	P552000	FUEL/WATER SEPARATOR	99% @ 30	RACOR 2000 SERIES
0.63	16	3.25	83	2.44	62	P552010	FUEL/WATER SEPARATOR	99% @ 30	RACOR 2010 SERIES
0.81	21	4.28	109	9.63	245	P552020	FUEL/WATER SEPARATOR	99% @ 30	RACOR 2020 SERIES
0.81	21	4.28	109	4.63	118	P552040	FUEL/WATER SEPARATOR	99% @ 30	RACOR 2040 SERIES



Box-Style Cartridge Filters

Width		Length		Height		Part No.	Part Description	Efficiency @ Micron	Primary Application
IN	MM	IN	MM	IN	MM				
Box-Style Cartridge Filters									
2.64	67	4.38	111	2.59	66	P552387	FUEL BOX PRIMARY	99% @ 22	GMC 25010487
2.83	72	4.61	117	2.46	62	P550955	FUEL BOX PRIMARY	99% @ 22	GMC 6.2 DIESEL, STANADYNE 23775
2.83	72	4.62	117	2.46	62	P556285	FUEL BOX PRIMARY	99% @ 10	THERMOKING 116285
2.83	72	4.62	117	2.46	62	P556286	FUEL/WATER SEPARATOR BOX	99% @ 30	THERMOKING 116286
2.83	72	4.62	117	2.46	62	P557264	FUEL/WATER SEPARATOR BOX	99% @ 30	THERMOKING 117264
3.28	83	6.31	160	2.64	67	P551049	FUEL BOX PRIMARY	99% @ 22	GMC V8-379, STANADYNE 27611
3.46	88	3.46	88	2.00	51	P502392	FUEL BOX PRIMARY	99% @ 35	DEUTZ 0319822, VOLVO 14514238
3.71	94	4.95	126	3.15	80	P551130	FUEL BOX PRIMARY	99% @ 22	JOHN DEERE AR50041, STANADYNE 20014
3.71	94	5.04	128	3.28	83	P556745	FUEL BOX PRIMARY	99% @ 22	JOHN DEERE AR86745, STANADYNE 26667
3.71	94	4.95	126	3.34	85	P559803	FUEL BOX PRIMARY	99% @ 22	CAT 8N-9850, STANADYNE 21167



P550955



P550955



P556285



P556286



P557264



P551049



P502392



P551130



P556745



P559803



In-Line Filters

Part No.	Primary Application	Outer. Dia.		Inlet Size	Length		Outlet Size	Efficiency @ Micron
		IN	MM		IN	MM		
In-Line Filters								
P550012	PICKUPS AND CARS -- UNIVERSAL 5/16" 2 HOSES 4 CLAMPS	1.94	49	5/16	4.17	106	5/16	99% @ 40
P550016	FORD D7TE9155A, MOTORCRAFT FG778 (1 HOSE 2 CLAMPS INCLUDED)	1.33	34	5/16	2.71	69	1/8-27	99% @ 100
P550090	FORD, GMC -- 2 HOSES 4 CLAMPS INCLUDED	1.94	49	3/8	3.88	99	3/8	99% @ 22
P550091	FORD, MOTORCRAFT FG14 -- 1 HOSE 2 CLAMPS INCLUDED	1.06	27	5/16	2.86	73	1/8-27	99% @ 100
P550094	UNIVERSAL 1/4" O.D. LINES,	1.94	49	1/4	4.06	103	1/4	99% @ 22
P550126	FORD E3FZ9155C	2.90	74	5/16	5.82	148	5/16	50% @ 23
P550209	GM LIGHT TRUCK	2.17	55	M16 x 1.5	4.29	109	M16 x 1.5	50% @ 23
P550433	CASE IH D145357	1.94	49	3/8	3.88	99	3/8	99% @ 150
P550446	JOHN DEERE AR103220, CUMMINS 3318919	1.89	48	5/8-24	3.54	90	5/8-24	99% @ 150
P550454	FORD D3FZ9155A, D2RY9155A -- 2 HOSES 4 CLAMPS INCLUDED	0.94	24	5/16	2.87	73	5/16	99% @ 100
P550504	GM LIGHT TRUCK, AC GF624, G580	2.28	58	3/8	6.38	162	3/8	50% @ 23
P550508	AC LIGHT DUTY, GF645, G645	2.28	58	M16 x 1.5	5.35	136	3/8	



P550012
PICKUPS AND CARS -- UNIVERSAL 5/16" 2 HOSES 4 CLAMPS



P550016
FORD D7TE9155A, MOTORCRAFT FG778 (1 HOSE 2 CLAMPS INCLUDED)



P550090
FORD, GMC -- 2 HOSES 4 CLAMPS INCLUDED



P550091
FORD, MOTORCRAFT FG14 -- 1 HOSE 2 CLAMPS INCLUDED



P550094
UNIVERSAL 1/4" O.D. LINES,



P550126
FORD E3FZ9155C



P550209
GM Light Truck



P550433
CASE IH D145357



P550446
JOHN DEERE AR103220, CUMMINS 3318919



P550454
FORD D3FZ9155A, D2RY9155A -- 2 HOSES 4 CLAMPS INCLUDED



P550504
GM LIGHT TRUCK, AC GF624, G580



P550508
AC LIGHT DUTY, GF645, G645



In-Line Filters

Part No.	Primary Application	Outer. Dia.		Inlet Size	Length		Outlet Size	Efficiency @ Micron
		IN	MM		IN	MM		
P550556	MOTORCRAFT FG1036	2.22	56	3/8	7.00	178	3/8	50% @ 23
P550593	FORD MOTORCRAFT FG19B	0.78	20	5/16	2.17	55	7/8-20	99% @ 100
P550967	FORD LIGHT TRUCK	3.08	78	5/16	6.77	172	5/16	50% @ 23
P550974	CUMMINS 3826094, CASE IH STX	1.94	49	3/8	3.93	100	3/8	99% @ 150
P551759	CHRYSLER 4554040	2.16	55	3/8	6.37	162	5/16	50% @ 23
P551760	ISUZU 825053640, 8251217780	2.32	59	5/16	5.47	139	5/16	50% @ 23
P551770	KOMATSU 20704A1100	1.88	48	1/2	4.34	110	1/2	99% @ 150
P551771	GM 25055347	2.00	51	1/2	4.35	110	1/2	50% @ 23
P551772	FORD F89Z9155A	2.30	58	5/16	7.00	178	5/16	
P552366	GM 5651944	2.28	58	5/8-18	4.75	121	3/8	50% @ 23
P552371	GMC 25121293	2.17	55	3/8	5.47	137	M16 x 1.5	50% @ 23
P552376	AMC 8933000076	3.07	78	3/8	6.06	154	5/16	50% @ 23



P550556
MOTORCRAFT FG1036



P550593
FORD MOTORCRAFT FG19B



P550967
FORD LIGHT TRUCK



P550974
CUMMINS 3826094, CASE IH STX



P551759
CHRYSLER 4554040



P551760
ISUZU 825053640, 8251217780



P551770
Komatsu 20704A1100



P551771
GM 25055347



P551772
FORD F89Z9155A



P552366
GM 5651944



P552371
GMC 25121293



P552376
AMC 8933000076



Part No.	Primary Application	Outer. Dia.		Inlet Size	Length		Outlet Size	Efficiency @ Micron
		IN	MM		IN	MM		
P552394	GMC 25175542; NISSAN 16400-D0100, TOYOTA	4.05	103	9/32	2.31	59	9/32	50% @ 23
P552397	GMC 25121472	2.28	58	3/8	6.47	164	3/8	50% @ 23
P552398	MITSUBISHI MB504753, MB658689; TOYOTA 23030-74020, 23300-19045	2.80	71	M14 x 1.5	4.37	111	M12 x 1.25	50% @ 23
P552399	GMC 25010487	2.05	52	5/16	2.11	54	5/16	
P552400	CHRYSLER MB504732, MB504750; SUZUKI 15410-61A00	2.80	71	M12 x 1.25	5.04	128	M12 x 1.25	50% @ 12
P552401	MITSUBISHI MB433774	2.07	53	5/16	2.82	72	5/16	
P552403	CHRYSLER 4443452, 4443454, 4549712	2.18	55	5/16	4.74	120	5/16	50% @ 11
P552437	NISSAN 16400-72L00	2.50	64	5/16	5.00	127	5/16	50% @ 23
P552439	CHRYSLER 4708317, 52019023, 52020016	2.15	55	5/16	6.22	158	5/16	50% @ 23
P552442	AUDI 893133511; FERRARI 117792; VOLKSWAGEN 447133511; VOLVO 13895628	3.46	88	M14 x 1.5	5.86	149	M12 x 1.5	50% @ 23
P552448	GMC 25121978	2.28	58	3/8	6.37	162	3/8	50% @ 23
P552482	JOHN DEERE RE38818	1.94	49	9/16-18	3.65	93	9/16-18	99% @ 150



P552394
GMC 25175542; Nissan 16400-D0100, Toyota



P552397
GMC 25121472



P552398
Mitsubishi MB504753, MB658689;
Toyota 23030-74020, 23300-19045



P552399
GMC 25010487



P552400
Chrysler MB504732, MB504750;
Suzuki 15410-61A00



P552401
Mitsubishi MB433774



P552403
Chrysler 4443452, 4443454, 4549712



P552437
Nissan 16400-72L00



P552439
Chrysler 4708317, 52019023, 52020016



P552442
Audi 893133511; Ferrari 117792;
Volkswagen 447133511; Volvo 13895628



P552448
GMC 25121978



P552482
JOHN DEERE RE38818

Twist&Drain™ Filter Kits

Each filter kit contains all the components you need to change over to a Donaldson Twist&Drain fuel filter water separating system – with coverage for over 400 on- and off-road vehicle applications.

Note

For complete manufacturer and application cross reference, see Brochure F111383 on DonaldsonFilters.com

Twist&Drain™ Kit Contents

- Water separating fuel filter with standard Twist&Drain valve
- Water collection bowl for easy visual inspection
- Alternative Twist&Drain valve with water-in-fuel (WIF) sensor or threaded port

Twist&Drain FUEL KITS
SERVICE TRAINING VIDEO



 youtube.com/user/donaldsonengine





Kit with Clear Water Collection Bowl and Standard Drain Valve



Kit Contents:

Fuel Filter Water Separator with Standard Drain Valve
P569758 Water Collection Bowl - Adds 1.98" (50mm) length

P559117 Filter Kit

P551026 Fuel Filter

Filter Length: 9.60" (244mm)
Efficiency: 99% @ 9µm

Kit with Clear Water Collection Bowl and Packard WIF Sensor



Kit Contents:

Fuel Filter Water Separator
P569758 Water Collection Bowl - Adds 1.98" (50mm) length
P570618 Packard WIF Sensor - Adds .35" (8.8mm) length

P559119 Filter Kit

P551026 Fuel Filter

Filter Length: 9.60" (244mm)
Efficiency: 99% @ 9µm

Kits with Clear Water Collection Bowl and Deutsch WIF Sensor



Kit Contents:

Fuel Filter Water Separator - Varies by Kit
P569758 Water Collection Bowl - Adds 1.98" (50mm) length
Deutsch WIF Sensors - Adds .71" (18.1mm) length

P559121 Filter Kit

P551026 Fuel Filter

Filter Length: 9.60" (244mm)
P570619 (Cummins WIF)
Efficiency: 99% @ 9µm

P559122 Filter Kit

P551026 Fuel Filter

Filter Length: 9.60" (244mm)
P573413 (John Deere WIF)
Efficiency: 99% @ 9µm

Kits with Clear Water Collection Bowl and 1/2"-20 UNF Threaded Sensor Port



Compatible with OEM WIF Sensor

Kit Contents:

Fuel Filter Water Separator - Varies by Kit
P569758 Water Collection Bowl - Adds 1.98" (50mm) length
P550865 Threaded Sensor Port - Adds no length

P559111 Filter Kit

P551065 Fuel Filter

Filter Length: 6.82" (173mm)
Efficiency: 99% @ 4µm

P559114 Filter Kit

P551075 Fuel Filter

Filter Length: 9.60" (244mm)
Efficiency: 99% @ 4µm

P559118 Filter Kit

P551026 Fuel Filter

Filter Length: 9.60" (244mm)
Efficiency: 99% @ 9µm

P559109 Filter Kit

P551056 Fuel Filter

Filter Length: 5.80" (147mm)
Efficiency: 99% @ 9µm

P559112 Filter Kit

P551066 Fuel Filter

Filter Length: 6.82" (173mm)
Efficiency: 99% @ 9µm

P559115 Filter Kit

P551076 Fuel Filter

Filter Length: 9.60" (244mm)
Efficiency: 99% @ 9µm

P559108 Filter Kit

P551055 Fuel Filter

Filter Length: 5.80" (147mm)
Efficiency: 99% @ 4µm

P559110 Filter Kit

P551057 Fuel Filter

Filter Length: 5.8" (147mm)
Efficiency: 99% @ 25µm

P559113 Filter Kit

P551067 Fuel Filter

Filter Length: 6.82" (173mm)
Efficiency: 99% @ 25µm

P559116 Filter Kit

P551077 Fuel Filter

Filter Length: 9.6" (244mm)
Efficiency: 99% @ 25µm

Diesel Fuel Filter Kits

Available in Australia Only

Contaminated fuel can lead to equipment and vehicle downtime resulting in costly repairs. Donaldson's range of Diesel Fuel Filter Kits have you covered from overhead and portable tanks, light to medium trucks and common rail applications.

Note

Product featured on this page is available in Australia.
Contact Donaldson Australasia Customer Service on 1800 345 837 to find a distributor near you.
Further information can be found on www.donaldsontoolbox.com.au

Bulk Fuel Tank Kit

For low flow applications. Ideal solution for overhead and portable tanks

Features and Benefits

- Simple spin-on design for ease of service
- Filtration efficiency 99.5% removal of particles 10 micron or larger ($\beta_{10}=200$)
- Water absorbing media
- T.R.A.P. breather included with kit to help remove moisture and airbourne contaminant, replaces desiccant and silica gel style breathers
- Kit includes adapters for head and breather to connect to connect to BSP fittings

Kit Part Number P902973

See pages 34 for additional diesel tank filtration kits.



Chassis Mount Diesel Fuel Filter Kit

For diesel platforms with flow rates up to 379LPH

Features and Benefits

- Ideal for light to medium trucks
- Filtration efficiency 99% removal of particle 3 micron or larger ($\beta_3=100$)
- Water separating filter and drain bowl
- Includes additional filter element

Kit Part Number P903074





Available in Australia Only

Common Rail Diesel Fuel Filter Kit

For diesel platforms with flow rates up to 114LPH

Features and Benefits

- Ideal for many 4WD applications
- Filtration efficiency 99% removal of particle 11 micron or larger ($\beta_{11}=100$)
- Water separating filter and drain bowl
- Includes additional filter element

Kit Part Number P902976



High Efficiency Diesel Fuel Filter Kit

For diesel platforms with flow rates up to 114LPH

Features and Benefits

- Ideal for many 4WD applications
- Filtration efficiency 99% removal of particles 3 micron or larger ($\beta_3=200$)
- Water separating filter and drain bowl
- Includes additional filter element

Kit Part Number P903316



Clean and Dry Diesel Filter Kit

For diesel fuel applications up to 189LPM

Features and Benefits

- Ideal for service vehicles, mobile tanks, fixed bulk tanks
- Maximum working pressure 350 psi
- Includes single head (2), high efficiency diesel filter, water absorbing filter, pressure gauge (2)

Kit Part Number P506073





Fuel Filtration

Donaldson Blue™ Filters for Cummins® ISX Engines



DBF5782 Cross Reference			
Cummins	Fleetguard	Baldwin	Wix
4964234	FF5782	BF7932	33944

Donaldson Blue™ DBF5782 for **Cummins® QSK engines** consistently retains particles under high pressure common rail fuel system dynamics (engine vibration), protecting your hard-working equipment and maximizing your uptime.

PERFORMANCE UNDER ENGINE VIBRATION AND PARTICLE RETENTION

Compared to the competition's best product, the Donaldson Blue DBF5782 with Synteq XP media averages **4x CLEANER** under heavy-duty vibration testing over the life of the filter. Lower particle release means less micro-contamination is flowing downstream to the fuel injectors.

START TO FINISH

4x cleaner fuel

THAN THE BEST COMPETITIVE FILTER

Donaldson Blue DBF5782 averages 4x lower particle concentration than the competition's best product.

Particle retention was tested under SAE J1985 single-pass test standards with added vibration. Test conducted March - April 2013 with a sample size of six filters per manufacturer.

Donaldson Blue DBF5782 provides cleaner fuel over the life of the filter

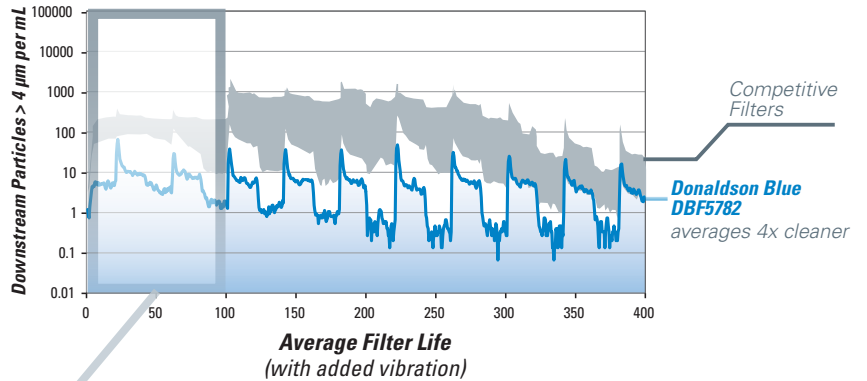

Donaldson Blue DBF5782 provides much cleaner fuel when first installed

Upstream particle concentration tested at >100,000 @ >4µm per mL

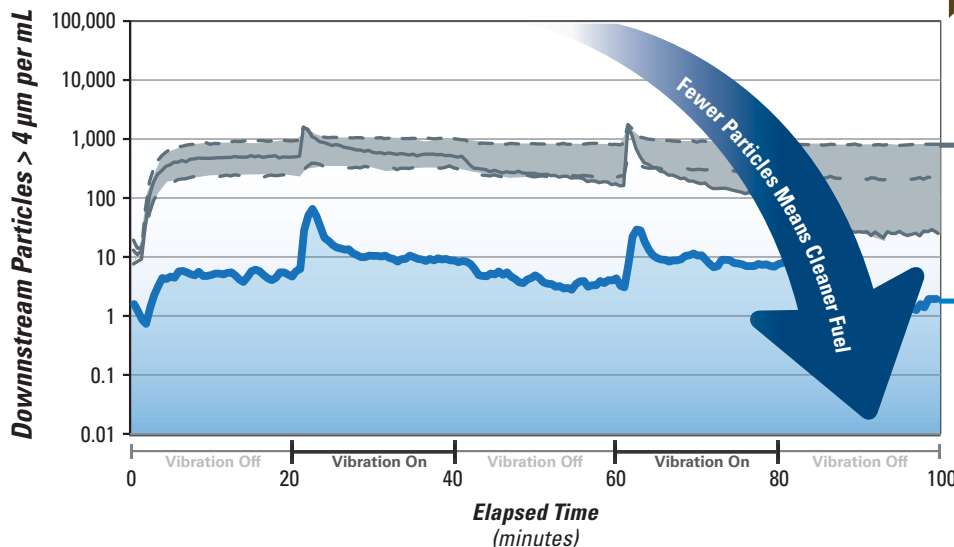

ISO 24 DIRTY FUEL IN

ISO 14 -16 COMPETITIVE FILTERS
Fuel cleanliness range of competitive filters

ISO 11 CLEAN FUEL OUT
Under these test conditions, **Donaldson Blue DBF5782** can deliver fuel cleanliness down to ISO 11. Competitor filters need to load with contaminant before reaching peak efficiency. Donaldson filters average 20x cleaner over the first portion of the filter's life.

Cummins® is a registered trademark of Cummins, Inc.



Donaldson Blue™ DBF5782 Fuel Filters Deliver Clean Fuel

UNDERSTANDING DIESEL FUEL CLEANLINESS

ISO 4406 contamination codes consist of three numbers corresponding to the number of particles 4 microns (µm) and larger, 6 microns and larger, and 14 microns and larger present in the fuel. Determining fuel cleanliness requirements includes measuring both the particle size and count.

The following chart illustrates what it means to start with heavily contaminated fuel levels of ISO 24/22/18 and how the **Donaldson Blue DBF5782** delivers exceptionally clean fuel. These results are based on SAE J1985 single-pass test standards with added vibration to simulate dynamic engine operating conditions.

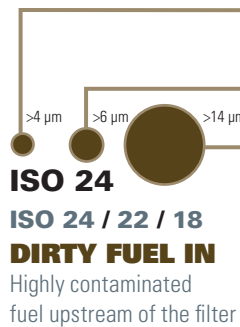
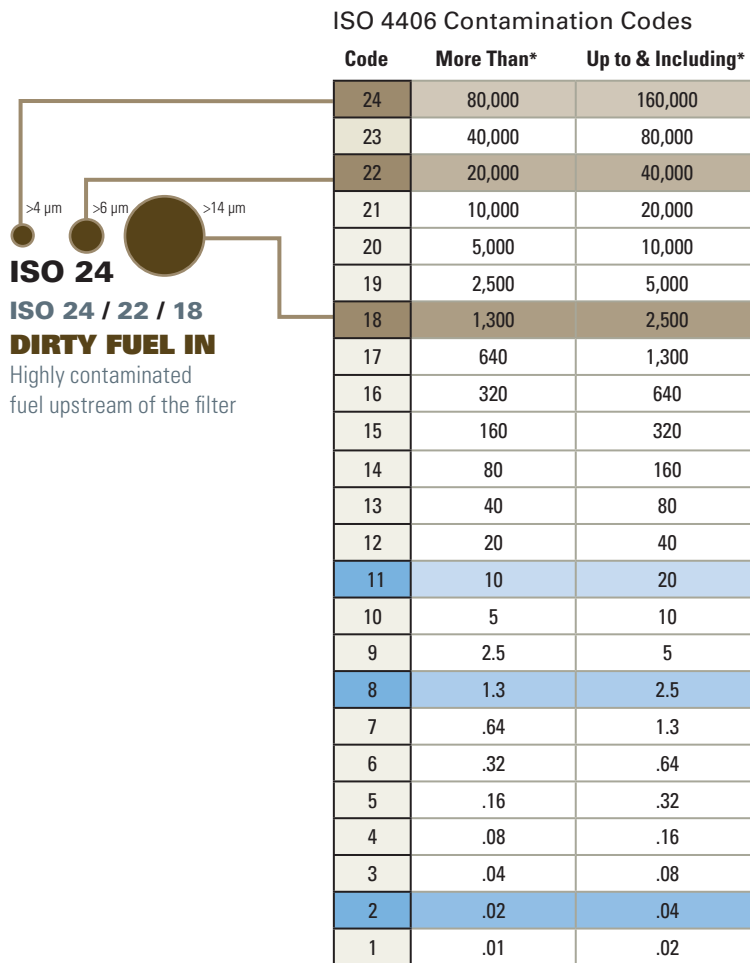

INTERPRETING THE ISO CODES
Example: ISO 24 / 22 / 18

ISO / /
>4 µm >6 µm >14 µm

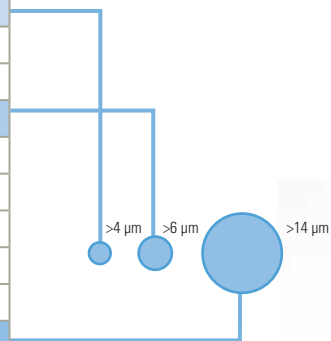

ISO 11
ISO 11 / 8 / 2
CLEAN FUEL OUT
Donaldson Blue DBF5782
The low particle count downstream of the filter makes the DBF5782 the best in its class.



Donaldson
BLUE™

Liquid Filtration Solutions

For Selective Catalytic Reduction (SCR) Systems

Denox 1.0 and 2.0 AdBlue® Filter Kits

Available in Europe and Australia Only

Note

Product featured on this page is available in Europe and Australia.

For other regions, please contact your Donaldson representative for availability.

In order to meet current and future Exhaust Emission Regulation, Selective Catalytic Reduction (SCR) are fitted with liquid AdBlue® (urea) injection systems which require high performance and reliable filtration.

Compressible devices in the Donaldson filter absorb urea volume expansion at low temperatures ($\leq -11^{\circ}\text{C}/12^{\circ}\text{F}$), adapting to extreme freezing conditions.

- They will not wear down or deteriorate during the filter's useful service life
- They are compatible with AdBlue® liquid as well as diesel fuel and other types of engine liquids

Bosch® Denoxtronics 1.0 Urea Injection System

Primary Application: DAF 1819795

Overall Dimensions: 69mm OD, 75mm Long

Kit Part No. X770733

Competitive Cross References

Name	Part No.
BALDWIN	PE5270
BOSCH	F00BH40012
BOSCH	F00BH40096
CUMMINS	3967874
DAF	1649425
DAF	1674458
DAF	1674485
DAF	1789050
DAF	1815766
DAF	1819795
DAF	18819795
DAF	42553548
DAF	649425
HENGST	E101UD178
IVECO	42553548
IVECO	42561571
IVECO	42562233
JURA FILTRATION	SN70332
MAN	81154036015
MAN	81154036089
MANN & HUMMEL	
..... U6202XKIT, U6202YKIT	
..... U6203YKIT, U6204XKIT	
NEOPLAN	81154036015
NISSAN/UD	20421NY00J
SCANIA	1545482
SCANIA	1761034
SCANIA	1795459
SCANIA	1852188
SCANIA	1907422
SF-Filter	SAB540SET
SOLARIS BUS (PL) ...	0120322535
SOLARIS BUS (PL)	120322535
VOLVO	20713630
VOLVO	20713636



Bosch® Denoxtronics 2.0 Urea Injection System

Primary Application:

Volvo Truck FE, FH, FL, FM Series, 20876498

Overall Dimensions: 68mm OD, 96mm Long

Kit Part No. X770734

Competitive Cross References

Name	Part No.
AGCO	V837062993
BALDWIN	PE5271
DEUTZ	2934622
CUMMINS	3986767
HENGST	E100UD160
IVECO	2997594
IVECO	42555073
IVECO	42555548
IVECO	42561605
JURA FILTRATION	SN70318
MANN & HUMMEL	U630XKIT
NEW HOLLAND	84254852
RENAULT VI	7420877950
RENAULT VI	7420877953
RENAULT VI	7421333098
SF-Filter	SAB541
VOLVO	20876498
VOLVO	20876502
VOLVO	21333097
VOLVO	21333097



AdBlue® is a registered trademark of the Verband der Automobilindustrie e.V (VDA).

Bosch® is a registered trademark of Robert Bosch GmbH



Overview	80-84
Diesel Engine Lube Filtration.....	80
Diesel Lube Oil Trends & Changes	80
Full Flow, By-pass or Two-Stage Filtration.....	81
Filter Media	82
What's Right For Your Engine?.....	84
Extended Service Oil and Filters	85-89
Donaldson Blue™ Lube Filters.....	86
Extended Oil Drain Intervals Oil.....	88
Oil Analysis.....	89
Filtration Systems – Filter & Head Designs	91
By-pass Filtration: 118 mm / (4.65") x 1 3/8"-16 dia. Flow Range up to 1.75 gpm / 6.62 lpm.....	92
Full-Flow Filtration: 93 mm / (3.66") x 1"-12 dia. Flow Range up to 20 gpm / 76 lpm	94
By-pass Filtration: 118 mm / (4.65") x 1½"-12 dia. Flow Range up to 45 gpm / 170 lpm	92
Lube Filters.....	98-104
Spin-on Filters.....	98
Cartridge Filters	104
Lube Filters for Cummins® ISX Engines	108



Diesel Engine Lube Filtration

Much of the developed world's infrastructure can be attributed to the application of the diesel engine. The evolution of the diesel engine has been significant since first patented by Rudolph Diesel in 1892. However, the working principle remains a constant. Much the same can be said of the lube or oil system within the modern diesel engine. The lube system functions as the central circulatory system to these powerhouses in order to keep them running at top performance. While the internal demands continue to evolve, the basic principles remain the same.



Today's diesel engines are tasked with running more efficiently, while leaving a smaller impact on the environment.

These demands continue to drive significant changes to engines and the supporting components. Lube filtration engineers continue to introduce technology to keep these lube systems functioning at peak performance while helping improve the environment through longer oil drain intervals and the introduction of green materials.

Donaldson introduced three extended life lube filters in the early 1980s for three popular U.S. engine makes: Detroit Diesel, Cat, and Cummins. Extended service in 1984 was primarily focused on a more robust filter that would last through an extended mileage interval.

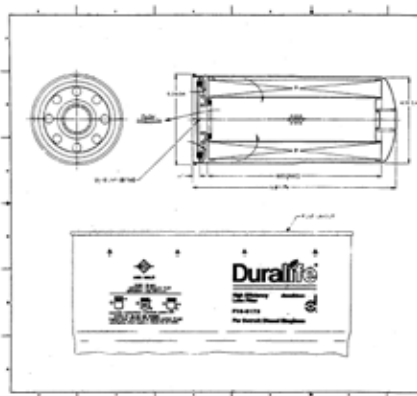

Engineering drawing of our first high efficiency, long life lube spin-on

Emission control technologies such as exhaust gas recirculation (EGR), diesel particulate filtration (DPF), and the introduction of closed crankcase ventilation (CCV) have a direct impact on the lube system. Today's oil handles more contamination for extended periods of time. A well designed lube filtration system is engineered up front with overall engine strategy in mind to provide maximum protection for the life of the engine. The benefits of this up front design have resulted in enhanced filtration medias and inclusion of traditionally separate components into a streamlined system.

Understanding end user needs is a commitment Donaldson takes seriously. It is with this in mind that we strive to offer design flexibility to meet field application needs. Longer life media, extended oil drain products, and traditional product offerings are combined to provide a solution for every unique diesel engine application.

Diesel Lube Oil Trends & Changes

Changes in Lube Oil Systems

- Increased EGR rates, soot & acid
- Crankcase ventilation – less oil consumption, thereby less make up oil added and oil has to work harder
- Improved cleanliness for tighter component clearances
- Typical contaminants
- Design strategies (bypass over-pressure valves, cold flow)

Changes in end user oils

- CJ-4 vs. CI-4 Plus
- Increased levels of fuel dilution due to alternate fuels
- New contaminants due to alternate fuels
- Low SAPS oil compatible with emissions aftertreatment systems

Filtration requirements evolving as a result

- Trend towards "green" cartridge filter
- System approach, integration of components such as oil coolers
- Enhanced protection while maintaining service intervals (bypass or secondary filters, extending service intervals & durable medias)



Full-Flow, By-pass or Two-Stage Filtration

The difference between the various lube filter configurations can be confusing. There are three common filtration approaches.

Full Flow Filtration

Full flow filters receive near 100% of the regulated flow in an engine lube system. Full flow filters provide essential engine protection for maximum cold flow performance and filter life. Most lube filters available today are full flow.

By-pass (Secondary) Filtration

By-pass filtration is when a small portion of the system's oil flow (usually 5-10%) is diverted back to the sump or oil pan before reaching the primary filter. A by-pass filter captures smaller particles than the full-flow filter. Because of the increased efficiency of a bypass filter, they are more restrictive. To optimize restriction, a bypass filter should be located in a separate flow path, as illustrated on the right.

Two-stage Filtration

A two-stage filter design attempts to combine the features of both a full flow and by-pass filter. The two-in-one design significantly increases restriction, causing shorter filter life and decreased cold flow performance. Poor cold flow performance starves the engine of oil during start up, leaving the engine temporarily unprotected. This may lead to increased engine wear that could result in premature repairs or even engine replacement.

Typical Engine Lube Filtration System

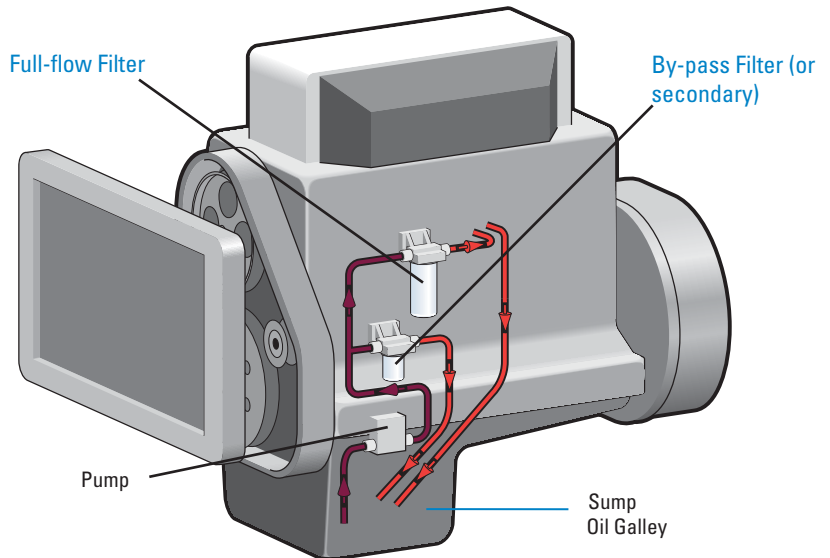

Typical Lube Circuit

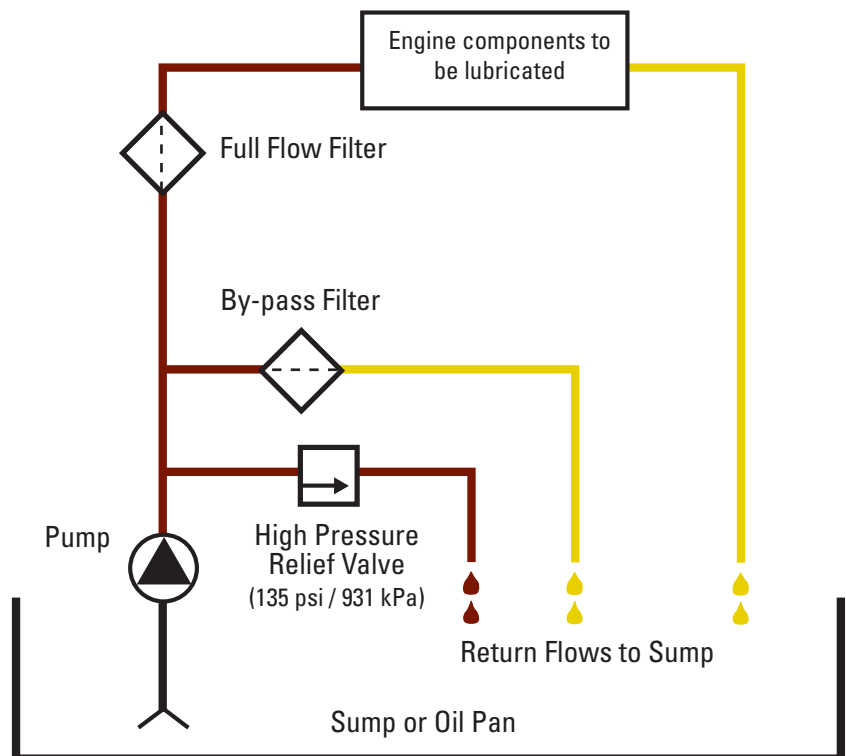



Filter Media

At Donaldson, we have a variety of lube filter medias available to meet the most stringent of engine lube system design requirements. Donaldson engineers have a history of developing media technology that exceeds application cleanliness and service life expectations. In fact, Donaldson was the first company to introduce fully synthetic media to the engine lube market in the early 1980s. This media is now commonly adopted for extended life or enhanced engine protection needs.

New lube media types are constantly under evaluation in our internal laboratories and in controlled field testing. If you have a specific application requirement, please contact Donaldson to see if there are additional media option to better suit your application.

Cellulose (traditional media)

Engine lube filter media is most commonly a pleated cellulose base material. This media effectively combines an application's efficiency and capacity requirements while maintaining cost effectiveness.

As oil flows through media, large contaminants are captured on the surface of the filter while smaller contaminant becomes embedded in the underlying media layer. Industry filtration performance standards (ISO 16889) are used to determine a performance rating. The combination of the size of the particles and number of particles that pass completely through the media are measured as a "beta ratio" function. The filtration performance characteristics of a lube system are typically specified by the engine manufacturer.

How it Works

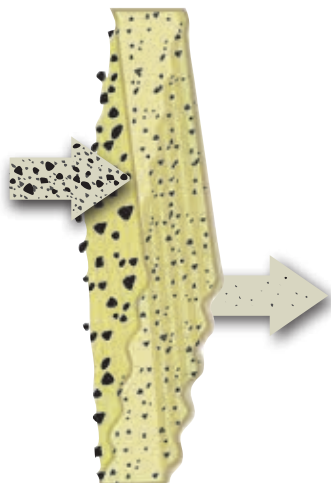

SEM 100x

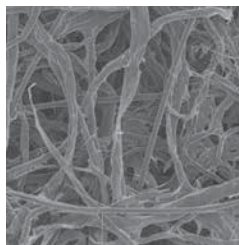

SEM 600x

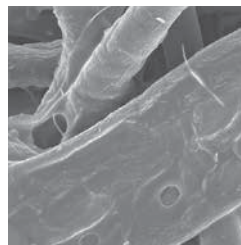

Media Image





Synthetic Blend (cellulose & synthetic media)

This media is a blend of cellulose and synthetic media technologies. It utilizes the best attributes of both media fiber types to achieve an improved cost to performance ratio for more demanding applications than a cellulose only media can achieve.

This media provides the consistency of layered fibers to capture coarse contaminant coupled with the affordability of cellulose to deliver an efficient and effective performance alternative to traditional cellulose media.

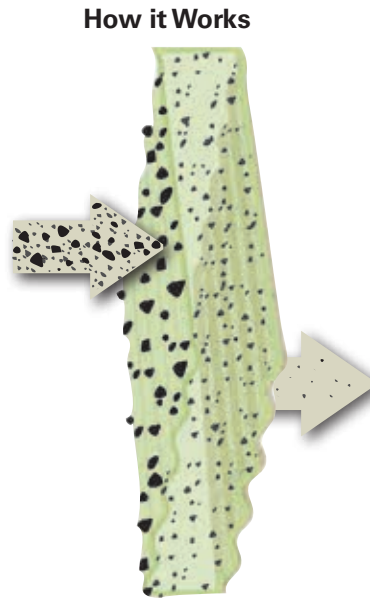

SEM 100x

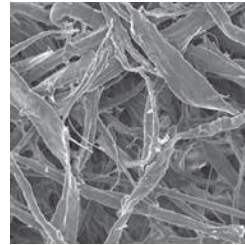

SEM 600x

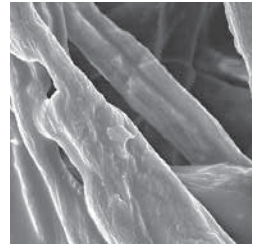

Media Image



Synteq™ Media (full synthetic media)

This engine lube filter media is constructed of layered, micro-fiberglass synthetic fibers and is trademarked Synteq™. It provides enhanced durability for extended drain intervals while maintaining or improving efficiency and capacity. Donaldson Synteq lube media also offers lower restriction. Low restriction allows better flow which ensures component protection over a larger range of engine conditions.

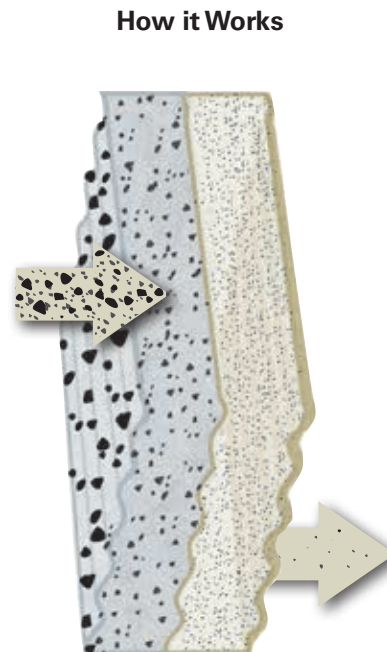

SEM 100x

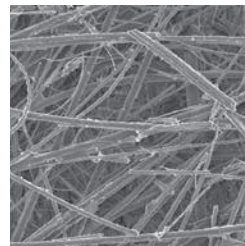

SEM 600x

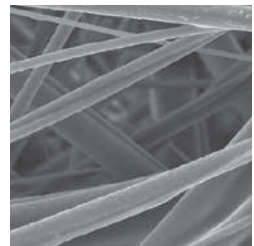

Media Image





Lube System Profile

At the end of this publication is a “tear-out” profile form for you to use to convey your system needs to Donaldson engineers.

The system profile has a list of all the design considerations required for proper engineering review to determine which Donaldson lube system would be the optimum solution.

- Lube system characteristics - oil flow rate, oil pressure, and temperature
- Filter change interval
- System functions - including pressure regulators, by-pass valve settings and anti-drain back
- Mechanical performance requirements - pressure, fatigue and vibration
- Filtration performance and test conditions
- Fitting and servicing considerations

As with most manufacturers, custom solutions require minimum annual production volumes and design and development phases. See page 143 for our lube filtration system design worksheet.

What's Right For Your Engine?

As you develop the future design of your engine or application, it is important to consider the filtration system needs. Depending on your objectives, it may be beneficial to choose from a catalog offering or partner with Donaldson for a filtration solution tailored to your application.

Reasons to Select a Standard System

- Low budget for engineering collaboration, development time or cost or component tooling
- Prefer to have parts readily available – want to avoid manufacturing lead times (8-12 weeks) and not interested in warehousing service parts
- Have a need mix and match head assemblies with various filter performance choices
- End users would prefer an established brand for filtration

Reasons to Consider a Custom System

- Engine design team is integrating new components that require a higher degree of filtration
- Looking for a system that does more; may include sensors, pumps, and/or heaters
- Have budget for engineering collaboration, development time/cost
- Interest in component / supplier consolidation – solutions that bridge a wide range of engine/vehicles
- Offering a unique solution with ease of maintenance

Common Liquid Filtration Terms

Spin-On: Filter encased in a metal housing for easier service

Cartridge: These fit into a filter housing which is spun on into a filter head

Cellulose Media: Media from wood fibers

Synthetic Media: This media is comprised of man made fibers and typically results in a lower pressure drop than cellulose media.

Housing: The place in which the cartridge filter fits into

Micron (µm): The measurement of minute particles of dirt

Pressure Drop: The pressure difference between the upstream and downstream flow

Pressure Regulating Valve: regulates the pressure depending on the liquid force detected at the end of the receiving piston

Sump or Oil Pan: crankcase or oil reservoir of an internal-combustion engine

Full Flow Lube Filter: filters the oil passing through the engine before it reaches the bearings

Bypass Lube Filter: removes smaller particulates than would be removed by an engine's normal filter, so that the need for additional oil or oil changes can be reduced

Baffle Plate or Thread Plate: mounted in the housing below the bearing will help retain the grease where it is needed



Extended Service Oil and Filters

Donaldson introduced three extended life lube filters in the early 1980s for three popular U.S. engine makes: Detroit Diesel, Cat and Cummins. Extended service in 1983 was primarily focused on a more robust filter that would last through an extended mileage interval.

Today, extended service filters are expected to last to the next oil change - in some cases this is double or triple traditional spin-on lube filters. Another major appeal with extended service filters is the “green” aspect – the use and disposition of fewer filters.

Extended Service Oil Drains

The key to any oil drain extension program is doing it safely to ensure not to create any harmful effects. The proper way to implement the change that is through oil analysis. Oil analysis measures critical oil parameters to ensure that the oil quality and is critical to establishing an extended drain.



Oil Analysis Kit X007374

Oil Considerations & Extended Drain Filters

Today’s mineral based oils are completely adequate for most heavy duty driving conditions and user needs. The formulations have evolved to the point that the serious problems of the past (such as viscosity breakdown) are no longer of concern for most applications. Additionally, the ability to readily combine with today’s additive packages and significantly lower price has helped mineral based oils remain the clear favorite.

Synthetic oils can perform better than mineral oils in extreme temperatures, both hot and cold. At sub-freezing temperatures, flow properties of synthetics are better. This means faster starts, and faster oil delivery through the engine. The benefit is better lubrication on start up and less work for your starting system. Synthetics are usually SAE 5W-40 / ISO VG 22-150 viscosity grade (mineral oils typically being SAE 15W-40/ISO VG 46-150) and allow a little better fuel economy (1-3%). However, driving habits have the most influence on fuel economy.

At high temperatures, synthetics are more oxidation resistant and less volatile than mineral oils. Less volatility can be a benefit, because less oil will be lost by evaporation, and may reduce the to top-off oil as frequently. High temperature oxidation resistance isn’t always a benefit.

Many older diesel engines don’t get hot enough to really challenge mineral oils that contain antioxidants. With more sophisticated emission control systems, engines may run hot enough to favor synthetic oil.

While there are clear benefits to synthetic oil, at least two drawbacks have hindered their wide spread adoption. The first issue is that synthetic oil has poor solubility for additives; making it harder to control for soot and Total Base Number (TBN) retention. All the while the base stock synthetic oil may remain useful, soot levels may exceed OEM guidelines or the oil may become too acidic. Secondly the price for synthetic oils is typically 3 – 4 times the cost of a comparable mineral oil. Combine the cost with the unlikely prospect of tripling an oil drain and synthetic oil becomes cost prohibitive.

Extended Service Filters

Donaldson Blue™ filters are for those who want to maintain oil health over the new drain interval and need a filter that can last as long as the oil.

Our Donaldson Blue lube filters use Synteq™ media. Synteq is more effective than standard cellulose filter media at removing small contaminants, it improves lubricant flow and offers increased dirt holding capacity for the extended service.

Donaldson Blue filters are direct replacements to standard filters – no system modifications and no special disposal requirements.



Donaldson Blue™ Lube Filters Help You Go the Extra Mile Delivering Extended Service Intervals



Donaldson Blue™ lube filters are designed for heavy-duty truck and diesel engine extended maintenance programs. Just a simple cross reference of your current lube filter and you'll reduce oil consumption, increase engine protection and reduce operating costs.

For most lube filters, the secret to balancing efficiency, capacity and restriction is hidden underneath the surface. Donaldson Synteq™ media technology provides the optimal balance of all three characteristics. Donaldson Blue filters are the definitive choice to protect equipment, reduce maintenance cost and increase equipment uptime.



Donaldson Blue™ lube filters with Synteq™ media reduce oil consumption, increase engine protection and reduce operating costs. They provide the optimal balance of efficiency, capacity and restriction, and remove more than **90% of contaminants** that are 10 microns or larger, compared to 50% or less for typical cellulose filters. At the same time, they deliver **nearly double** the contaminant carrying capacity of standard cellulose filters. Fully synthetic Synteq media also delivers **lower restriction** to provide **maximum oil flow**. Donaldson Blue lube filters are designed specifically to provide **longer filter life** – a critical component of any extended filter maintenance program.



Upgrade from a Competitive Filter to Donaldson Blue™

Donaldson Blue filters are direct replacements to standard filters – no system modifications or special disposal requirements.

Donaldson Blue™	Donaldson Standard	Fleetguard	Baldwin	Luber-finer	Wix	Primary Application
DBL3998	P552100	LF9620	B495MPG	LFP2160XL	51971XD	Detroit Diesel Series 60 Engines
DBL7300	P553000	LF9039	BD7309	LFP3000XL	51748XD	Cummins® Engines
DBL7345	P558616	LF3805	—	—	—	Cummins® 4B 3.9 Series Lube
DBL7349	P558615	LF9028	BT7349	LFP780XL	57620XE	Cummins® 4B and 6.B Series Lube
DBL7367	P550367	LF9026	—	LFP2285XL	—	Navistar Engines
DBL7405	P554005	LF9691	B7249MPG	LFP4005XL	51792XD	Caterpillar Engines
DBL7483	P553191 / P550519	LF9667	—	LFP3191XL	—	Mack/Volvo Engines
DBL7670	P551670	LF9325	B96MPG	LFP670XL	51970XD	Cummins® Engines/ Detroit Diesel Engines
DBL7690	P550769	LF16046	—	—	57213	Mercedes Engines
DBL7739	P554004	LF3379	B76MPG	LFP3191	51791XE	Caterpillar Equipment
DBL7900	P559000	LF9031	—	—	57746XD	Cummins® ISK Engines and ISM Engines
DBL7947	P550947	LF3363SC	—	—	—	Detroit Diesel Engines



Extended Oil Drain Intervals

Extended Oil Drain Intervals Oil service intervals are pre-determined by engine manufacturers (OEM's) and are designed to provide maximum engine protection under a wide variety of conditions. While a majority of equipment owners follow these guidelines there is a growing trend to extend oil service intervals beyond the OEM recommendations. However, Extended Oil Drain Intervals (EODI) are not for every application. To fully understand the risks involved you must look at the key factors affecting EODI's.

Engine lubricating oil is often referred to as the life blood of the engine. This analogy is not made simply because the oil circulates through the engine but more importantly because the oil performs critical functions necessary to maintain engine performance and maximize useful service life. There are two basic types of oil available today: mineral and synthetic. While these oils are completely different in composition, they must still meet the American Petroleum Institutes (API) qualification criteria recommended by the engine manufacturers. There are many suppliers of oil in the market today and not all meet the stringent requirements of the API standard. Insuring your oil meets these requirements and understanding the factors affecting the engine oil is the first step before extending your oil service interval.

Equipment operating extremes of heat, cold, idle time, airborne contaminants, and engine load adversely affect engine oil. Excessive Heat will break down engine oil and create deposits in the engine adversely affecting engine life. Severe cold will limit the ability of the engine oil to lubricate at start-up and may add unwanted moisture and unburned fuel to the oil. Extended Idle Time can result in increased amounts of unburned fuel entering the oil resulting in oil dilution and inadequate lubrication. Extreme dust conditions may tax even the best air filtration system adding fine contaminants to the oil overloading the additive package that keeps them in suspension. Heavy loads on the engine can produce extra heat putting a greater demand on the cooling system and increasing the importance of cooling system maintenance during EODI's. Off-road operation will likely see more of these extremes than on-highway operation.

Engine designs today are cleaner burning with reduced emissions and make excellent candidates for extended oil drain intervals. However, most customers cannot afford to buy new equipment every year and normally fleets have a mixture of equipment varying in vintage and service life. As piston rings and valve guides wear in the engine, combustion by-products increase. These combustion by-products end up accelerating oil additive depletion and can create harmful deposits on internal engine surfaces making the engine less likely to benefit from an EODI.

Oil filters remove contaminants from the oil before they generate wear on engine component surfaces. There are many filtration products offered in the industry today with some claiming to allow for extended oil drain intervals. The fact is, the filter alone will not extend the life of engine oil. The filter has one function, and that is to filter contaminants from the oil. While most filters today do an excellent job in filtering, the trend of extending oil drain intervals 2 to 3 times the normal service interval has pushed the materials used in the manufacture of filters to the limit. Adhesives, rubber compounds, filter media, and even the steel construction in spin-on filters needs to be designed to meet the extended period of time they are expected to be in service. Before considering an EODI make sure the filter manufacturer will warranty their product when used in this manner.

If after considering all the factors affecting extended oil drain intervals you feel your equipment is a candidate for EODI's you will need to develop a test program to determine what length EODI is right for your equipment. To determine the correct length EODI you must first implement an oil analysis program to develop history on each piece of equipment scheduled for extended oil service. This will allow you to determine if there is any usable life left in the oil. The primary indicators will be silicon (dirt), viscosity (oil film strength), soot (combustion by-product), and total base number (TBN). Most engine manufacturers have oil analysis guidelines.



Typically you will want to keep your silicon within 15ppm of the initial oil sample, your viscosity within the original oil grade specifications, soot below 3%, and the TBN number above 3. Each piece of equipment will vary and the key is to look for trends in the analysis. If oil analysis indicates you can extend your service interval you then need to move out in steps. Oil analysis should continue at the normal service interval and in increments of 20% thereafter until the analysis shows the useful life of the oil deteriorating. Once the maximum limit on the oil is reached the change interval should be set at the mileage of the previous sampling prior to indications of oil deterioration. Example: Normal service interval = 16,000 miles (25,000 km). Oil analysis performed at 16,000 (25,000 km), 19,200 (30,000 km), 22,400 (35,000 km), 25,600 (40,000 km), and 28,800 (45,000 km). If oil analysis indicates problems at 28,800 (45,000 km) the change interval should be backed off to 25,600 miles (40,000 km). This will allow for variables in operation and environment.

Extended oil drain intervals are not without risk and short term cost savings benefits should be balanced equally with engine performance and reliability. With all of the factors affecting the engine oil it is easy to see why OEM's have traditionally been conservative in setting oil drain intervals. If you think your equipment is a candidate for EODI program, do some research. Check with your filter, engine, and oil manufacturer for guidance. If you're not doing oil analysis, start a program. Review your filtration package and most of all understand the potential risks involved. If not properly implemented EODI short term savings are offset by expensive repairs and downtime further down the road. Always dispose of used engine oil and filters properly.

Re-printed with permission of the Filters Manufacturer's Council : Technical Service Bulletin 98-1

Oil Analysis

Donaldson uses independent laboratories for oil analysis services and these labs are typically different from region to region. Each provides fast and accurate information about the status of your equipment. We only select labs and programs have have proven laboratory techniques and covers a wide range of systems and applications. Typical oil analysis service includes evaluating the results of the tests we perform and providing detailed reports, including specific maintenance recommendations.

Vehicle owners use the data and recommendations to improve preventive maintenance, reduce equipment downtime, and reduce overall cost of lubricants by extending oil drain intervals.



Typical Oil Sampling Steps

- Collect the oil sample with sampling device
- Complete a lab processing form
- Labeling the sample with vehicle id, hours, miles, etc.
- Send the sample to lab
- Lab returns results - via mail or on-line.

Recommended Sampling Intervals

On-Road Engines

Diesel	10,000 miles / oil change
Gasoline	3,000 miles / oil change
LPG	3,000 miles / oil change
Non-Engines	20,000 miles / 500 hours

Off-Road Engines

Diesel	250 hours / oil change
Gasoline	150 hours / oil change
LPG	150 hours / oil change
Non-Engines	500 hours / monthly



Oil Analysis Kit for Fleets and Off-Road Vehicles and Equipment

Use X007374 for routine oil analysis for diesel engines or hydraulic oil reports on wear metals and additives.



Kit Part No. X007374

Metals, ppm by wt	◆
Viscosity, cSt.	◆
Water %	◆
Fuel % by Infrared	◆
Soot by Infrared	◆
Glycol (Coolant)	◆

Sampling Accessories

These accessories can simplify your oil analysis during the normal maintenance routines.

Plastic Tubing Part No. P176433

Sampling Pump Part No P176431



Sampling Pump & Plastic Tubing
(sold separately in 100 ft. rolls)

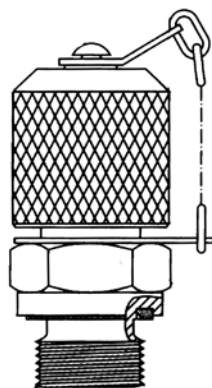

Quick Sampling Valve.

Oil Analysis Program Video Available on YouTube®

Donaldson recommends oil analysis as a fast and highly accurate way to assess what's in your engine's oil. An overview video is available on our YouTube channel as a resource for understanding our engine oil analysis program. This video reviews why a preventative maintenance program is important, how the analysis works, and how to read the lab report.

SERVICE TRAINING VIDEOS



youtube.com/user/donaldsonengine

Sample Processing/Reporting

Labs will request that you send your oil sample(s) as soon as possible after collecting. The oil samples do not "break down," but any long delay between sampling and analysis can be crucial if a unit is failing.

Once the oil sample reaches the lab, we will process it within 24 hours. You will be notified by phone/fax if critical conditions are present.

Features of the Report:

- Up to 6 sets of test results (current and 5 previous) displayed
- Spectrochemical and physical results underlined where applicable
- Full headings for all results



Lube Filtration Systems

The following pages present Donaldson's catalog product offering for Lube Assemblies. Product offering includes both by-pass and full-flow filtration designs.

Use the matrix below to determine the filtration system that best matches up with the flow requirements and the key features for design and mounting on your engine.

Filter Performance Choices

The filter tables provide you with the separate filters that fit the same head assembly – these differ by length and filter performance. Choices are presented by level of efficiency.



Lube Filter Mix & Match Choices

Mix and Match Lube Filter Systems		
Families by Filter Diameter ϕ	Flow Range	Features
93 mm / 3.54"	20 gpm / 76 lpm	Standard design for full flow filtration, top mount, single port head, spin-on filter
118 mm / 4.65"	1.75 gpm / 6.62 lpm @ 85 psi	Standard design for bypass filtration, side mount, single port heads, spin-on filter
	45 gpm / 170 lpm	Standard design for full flow filtration, top mount, single port head, spin-on filter

How Donaldson Displays Filter Flow versus Pressure Loss Data

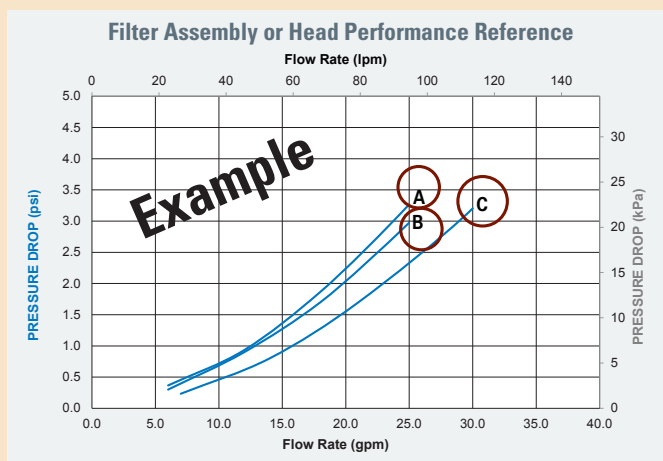

Performance Curve Notes

- Pressure loss was tested per the ISO 3968 standards.
- All flow measurements were made with Mobil DTE Light oil at 144°F (62.2°C), 15 cSt.
- Test conducted with a sample size of three filters.
- Filter performance curves will list an alpha reference (see circled areas on chart). These labels correspond with the filter choice tables.



By-Pass Lube Filtration

Filter Dia. 118 MM (4.65") X 1 3/8"-16



Flow Range: up to 1.75 gpm / 6.62 lpm

Operating Pressure

Up to 150 psi (1034 kPa)

Flow Rate

1.75 gpm / 6.62 lpm @ 85 PSI

Oil Compatibility

Compatible with petroleum based fluids (hydrocarbon) and up to 20% biodiesel

Head Part No.
P174777

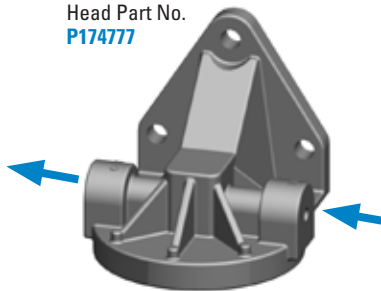

Threaded stud not viewable, due to angle of view

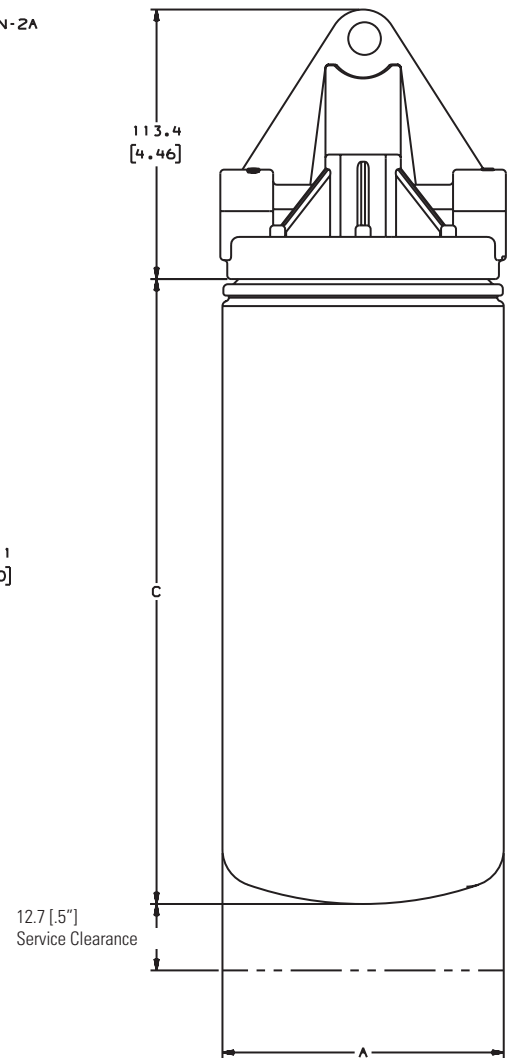
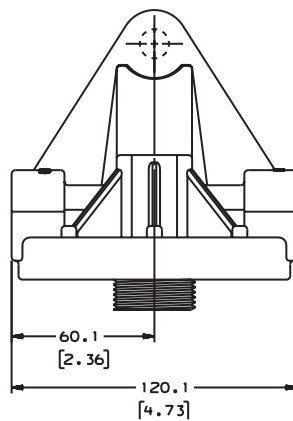
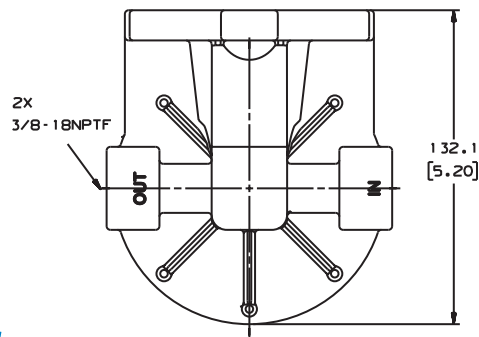
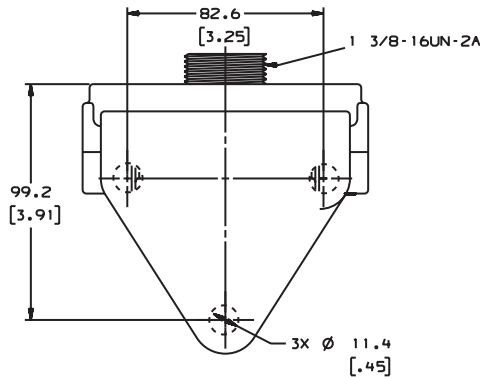
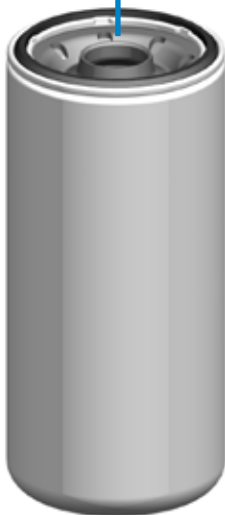



Filter Selection Chart

Outer Diameter		(C) Filter Length		Media Type	Efficiency @ Micron	Part Number	Performance Curve	Gasket Outer Diameter		Gasket Inner Diameter	
in	mm	in	mm					in	mm	in	mm
4.65	118	8.94	227	Cellulose	99% @ 23	P550777	A	4.32	110	3.85	98

Performance Curves

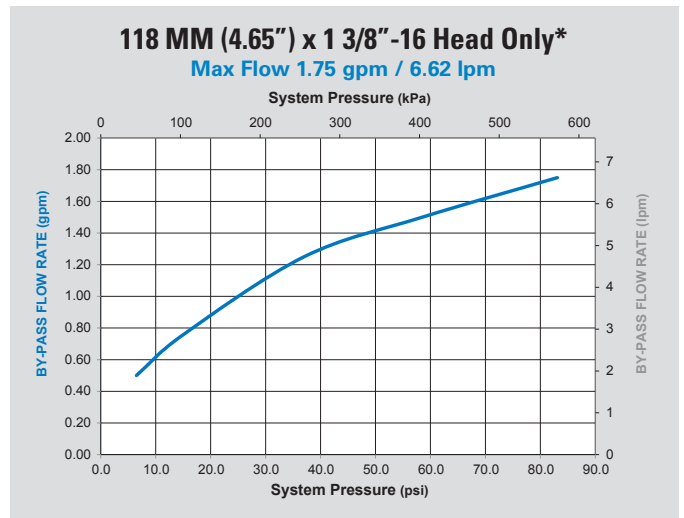
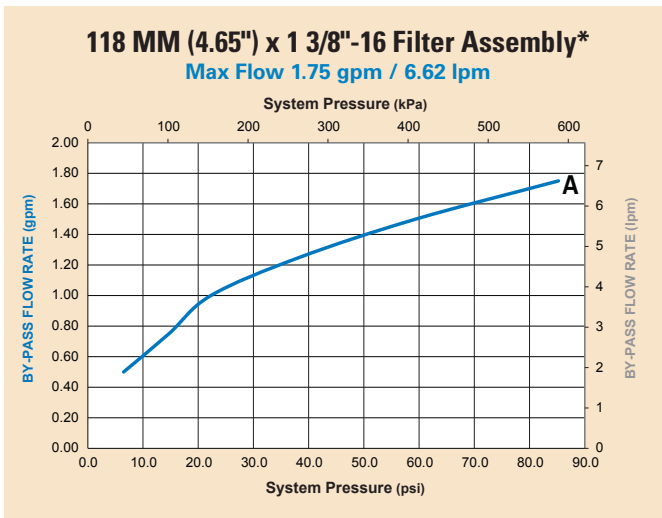

*These performance curves represent clean filter by-pass flow as a function of system pressure.



Full-Flow Lube Filtration

Filter Dia. 93 MM (3.66") X 1"-12



Flow Range: up to 20 gpm / 76 lpm

Operating Pressure

Up to 150 psi (1034 kPa)

Flow Rate

Up to 20 gpm / 76 lpm

Oil Compatibility

Compatible with petroleum based fluids (hydrocarbon) and up to 20% biodiesel

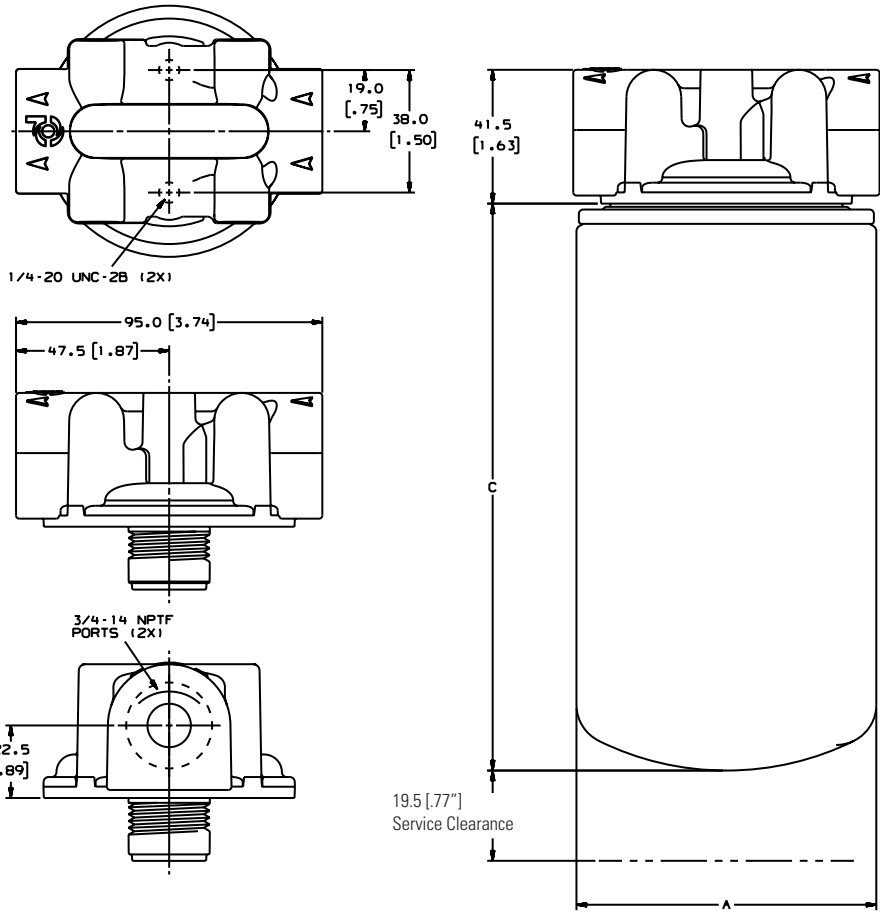

Head Part No.
P561134

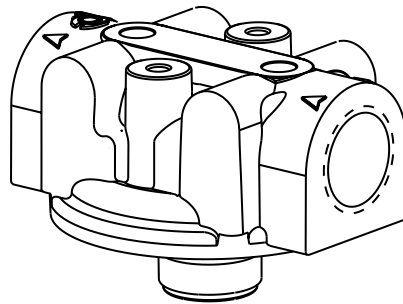



Filter Selection Chart

Outer Diameter		(C) Filter Length		Media Type	Efficiency @ Micron	Part Number	Performance Curve	Anti-Drain Back Valve	Filter Relief Valve Setting		Stand Tube	Gasket Outer Diameter		Gasket Inner Diameter					
in	mm	in	mm						PSI	Bar		in	mm	in	mm				
3.66	93	5.35	136	Cellulose	99% @ 40	P552819	B	Yes	18-23	1.30-1.60	No	2.83	72	2.42	61				
				Cellulose		P555680	C		18-23	1.30-1.60	No								
		6.85	174	Cellulose		P553712	C				No								
				Cellulose		P555616	A	Yes			Yes								
				Cellulose		P557207	C		7-10	0.50-0.70	No								
7.87	200	Cellulose	P553771	A		Yes	35	2.41	No										
3.74	95	5.35	136	Cellulose		P559418	B	Yes	36	2.48	No								
3.81	97	6.85	174	Cellulose		P558250	B	Yes	11-17	0.80-1.00	No								

Performance Curves

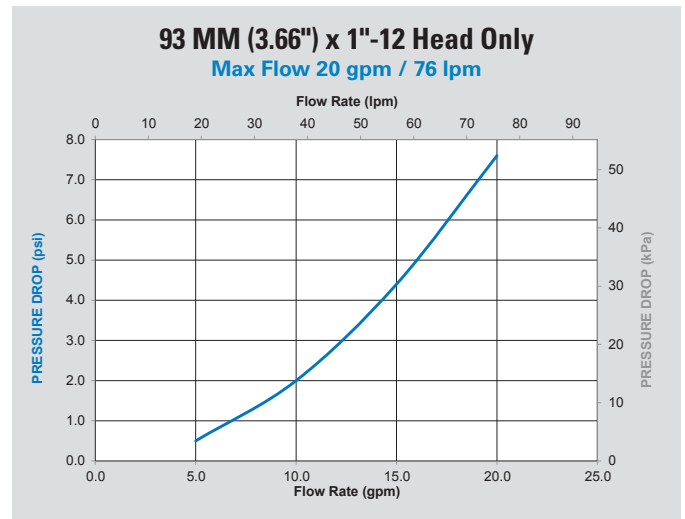
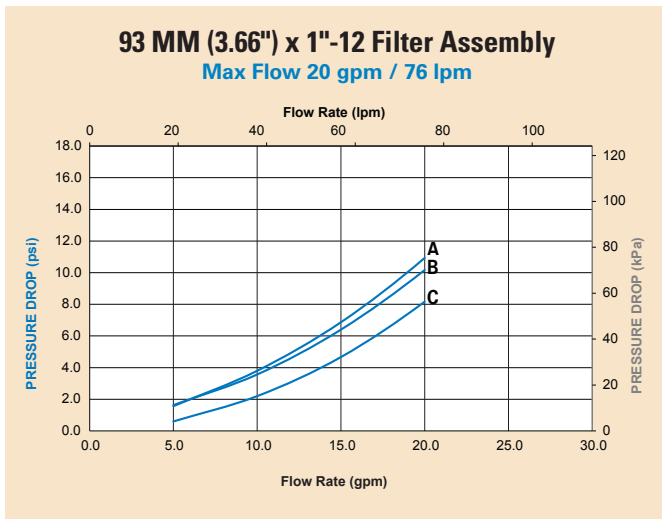



Full-Flow Lube Filtration

Filter Dia. 118 MM (4.65") X 1 1/2"-12



Flow Range: up to 45 gpm / 170 lpm

Operating Pressure

Up to 150 psi (1034 kPa)

Flow Rate

Up to 45 gpm / 170 lpm

Oil Compatibility

Compatible with petroleum based fluids (hydrocarbon) and up to 20% biodiesel

Head Part No. **P174780**

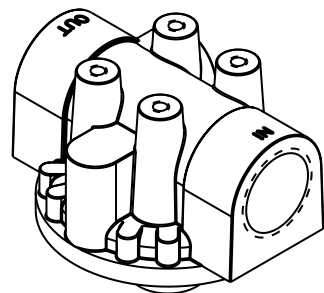
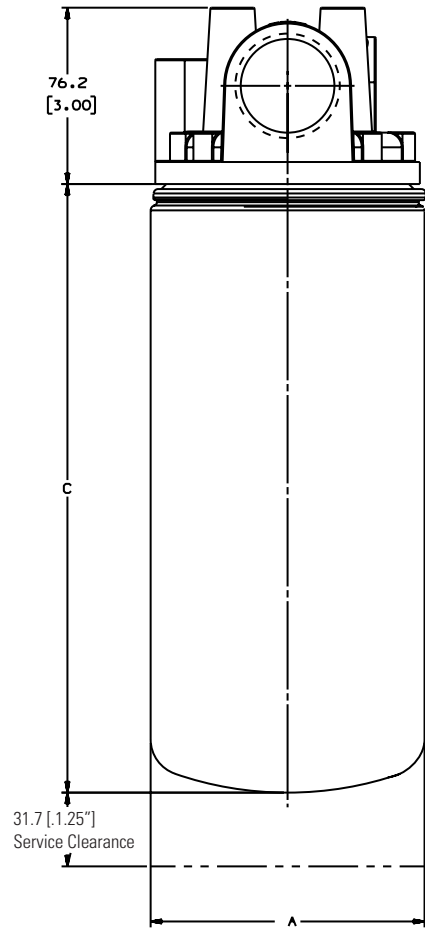
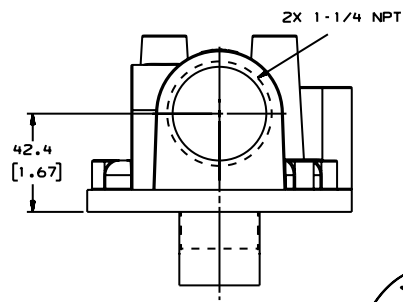
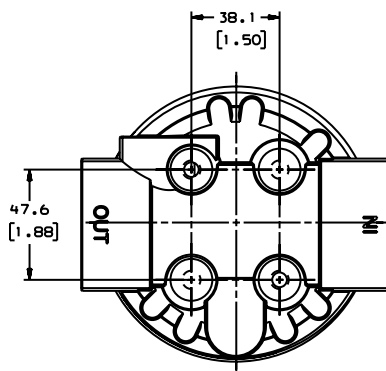
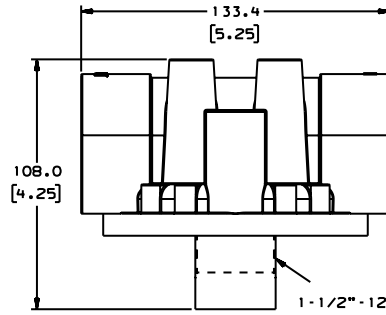



Filter Selection Chart

Max. Recommended Flow Rate		Outer Diameter		(C) Filter Length		Media Type	Efficiency @ Micron	Part Number	Performance Curve	Gasket Outer Diameter		Gasket Inner Diameter	
gph	lph	in	mm	in	mm					in	mm	in	mm
25	95	4.65	118	6.22	158	Cellulose	99% @ 23	P550947	A	4.32	110	3.85	98
						Synteq	99% @ 16	DBL7947	B	4.31	109	3.84	98
30	114			7.83	199	Cellulose	99% @ 40	P551381	C	4.32	110	3.85	98
35	132			8.94	227	Cellulose	99% @ 23	P550671	D	4.32	110	3.85	98
45	170			10.24	260	Synteq	99% @ 16	DBL7670	E	4.31	109	3.84	98
				Cellulose	99% @ 23	P551670	E	4.32	110	3.85	98		

Performance Curves

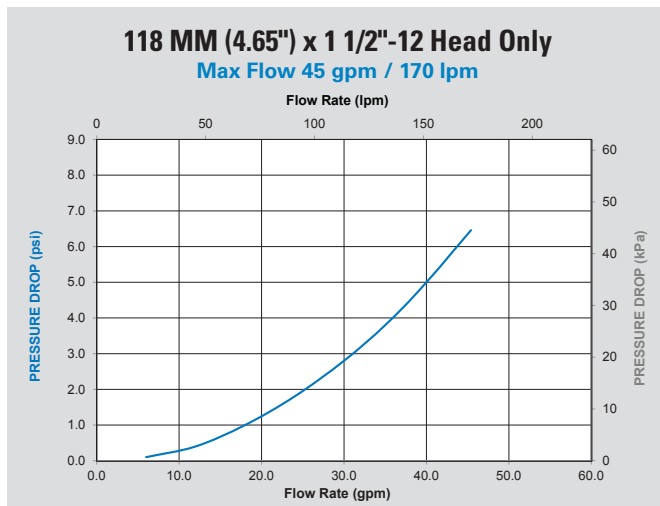
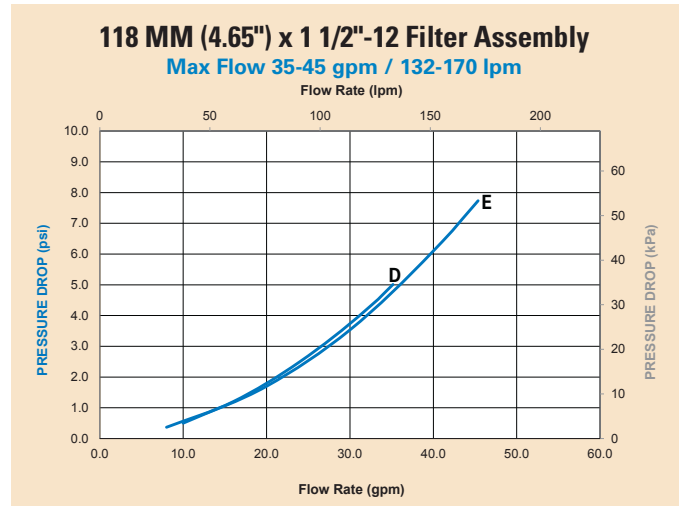
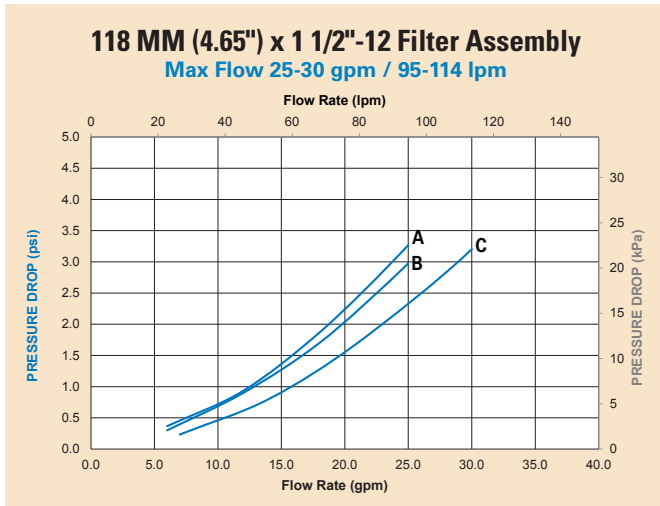



Spin-On Filters

Thread	OD		Length		Part No.	Part Description	Efficiency @ Micron	Primary Application	Anti-Drain Back Valve	By-Pass Valve Setting		GSKT O.D.		GSKT I.D.	
	IN	MM	IN	MM						PSI	Bar	IN	MM	IN	MM
68 mm / 2.68" Diameter Family															
3/4-16	2.56	65	2.80	71	P502015	FULL FLOW	50% @ 20	TOYOTA 90915-03001, 90915-10001	Yes	11-17	0.80-1.00	2.46	62	1.94	49
	2.56	65	3.54	90	P502019	FULL FLOW	50% @ 20	TOYOTA 90915-03004				2.46	62	1.94	49
	2.56	65	3.35	85	P502070	FULL FLOW		NISSAN 1520853J00				2.46	62	2.06	52
	2.56	65	2.80	71	P550534	FULL FLOW		DATSUN, TOYOTA SUZUKI	Yes	11-17	0.80-1.00	2.46	62	1.94	49
	2.68	68	2.56	65	P502024	FULL FLOW	50% @ 20	BRIGGS & STRATON 492932, SUZUKI, DAIHATSU, MAZDA	Yes	11-17	0.80-1.00	2.56	65	2.20	56
M20 x 1.5	2.68	68	3.34	85	P502007	FULL FLOW	50% @ 20	MAZDA FEY014302	Yes	11-17	0.80-1.00	2.67	68	2.15	55
	2.68	68	3.35	85	P502047	FULL FLOW	50% @ 20	ISUZU 94314263				2.58	66	2.15	55
	2.68	68	3.35	85	P502057	BYPASS	50% @ 20	MAZDA FEY014302	Yes			2.56	65	3.03	77
	2.68	68	2.56	65	P502062	FULL FLOW	50% @ 20	KIA				2.58	66	2.17	55
	2.68	68	3.35	85	P502063	FULL FLOW	50% @ 20	MAZDA JEY014302	Yes	11-17	0.80-1.00	2.58	66	2.15	55
	2.68	68	2.56	65	P502067	FULL FLOW	50% @ 20	NISSAN, MAZDA, MITSUBISHI	Yes	11-17	0.80-1.00	2.56	65	2.19	56
	2.69	68	2.78	71	P551783	FULL FLOW		HONDA 15410MM90003				2.42	61	2.23	57
76 mm / 3.00" Diameter Family															
3/4-16	2.92	74	3.40	86	P552430	FULL FLOW	50% @ 24	HARLEY-DAVIDSON 63805-80A				2.73	69	2.42	61
	2.92	74	4.53	115	P551763	FULL FLOW		KOHLER 1205001, CUB CADET	Yes	8	0.55	2.73	69	2.43	62
	2.91	74	3.31	84	P502016	FULL FLOW	99% @ 50	TOYOTA 90915-03002, 90915-20001							
	3.00	76	3.46	88	P502107	FULL FLOW	50% @ 20	ECHLIN OF18				2.80	71	2.50	64
	3.00	76	3.40	86	P550335	FULL FLOW	50% @ 20	MOPAR L335, CHRYSLER, CLARK, INTERCEPTOR MARINE	Yes	7-10	0.50-0.70	2.75	70	2.37	60
	2.99	76	4.72	120	P554770	FULL FLOW	50% @ 20	JOHN DEERE AM34770	Yes	26-30	1.80-2.10	2.75	70	2.37	60
	3.00	76	3.42	87	P551251	FULL FLOW		OPEL 2866477		8-11	.60-.80				
	3.00	76	4.74	120	P550400	FULL FLOW	99% @ 40	FORD E1FZ6731A, MOTORCRAFT FL400	Yes	7-10	0.50-0.70	2.75	70	2.37	60
13/16-16	3.00	76	5.53	140	P554408	FULL FLOW	99% @ 48	PERKINS 2654408, MF	Yes	8-11	0.60-0.80	2.83	72	2.44	62
	2.92	74	4.83	123	P550598	FULL FLOW	50% @ 25	GM 25010324				2.73	69	2.43	62
	2.96	75	4.45	113	P550505	FULL FLOW	99% @ 40	GM LIGHT TRUCK, AC PF59, PH59	Yes			2.77	70	2.36	60
M18 x 1.5	2.99	76	3.41	87	P551307	FULL FLOW	99% @ 40	GM 6439857,25010325	Yes			2.84	72	2.47	63
	3.00	76	3.40	86	P550047	FULL FLOW	99% @ 45	AMC, GMC 25010792	Yes	7-9	0.50-0.60	2.76	70	2.39	61
M20 x 1.5	3.00	76	5.09	129	P550051	FULL FLOW	99% @ 45	GMC 25010908	Yes			2.76	70	2.39	61
	2.96	75	4.75	121	P552849	FULL FLOW	99% @ 36	FORD, MAZDA	Yes	11-17	0.80-1.00	2.70	69	2.33	59
M22 x 1.5	3.00	76	2.52	64	P502010	FULL FLOW		MITSUBISHI MD322508				2.48	63	2.03	52
	3.00	76	3.26	83	P550794	FULL FLOW		GM 2007 LIGHT TRUCK							
80 mm / 3.15" Diameter Family															
3/4-16	3.15	80	3.15	80	P502020	FULL FLOW	50% @ 20	TOYOTA				2.48	63	2.20	56
	3.15	80	2.95	75	P502022	FULL FLOW	50% @ 20	ATLAS COPCO, BMW, DAIHATSU, SUZUKI	Yes	11-17	0.80-1.00	2.48	63	2.03	52
	3.15	80	2.72	69	P502069	FULL FLOW	50% @ 20	NISSAN 1520801B10				2.46	62	2.00	51
	3.24	82	4.40	112	P550715	FULL FLOW	99% @ 40	KUBOTA 15426-32430	Yes	16-19	1.00-1.30	2.58	66	2.26	57
	3.24	82	3.90	99	P550711	FULL FLOW	99% @ 45	NISSAN 15208-H8911	Yes			2.26	57		



Thread	OD		Length		Part No.	Part Description	Efficiency @ Micron	Primary Application	Anti-Drain Back Valve	By-Pass Valve Setting		GSKT O.D.		GSKT I.D.	
	IN	MM	IN	MM						PSI	Bar	IN	MM	IN	MM
M20 x 1.5	3.12	79	3.87	98	P555522	FULL FLOW	99% @ 50	THERMOKING 11.5522, J.DEERE, YANMAR	Yes	11-17	0.80-1.00	2.45	62	2.15	55
	3.15	80	2.52	64	P502009	FULL FLOW	50% @ 20	mitsubishi MD136466	Yes	11-17	0.80-1.00	2.48	63	2.03	52
	3.15	80	3.15	80	P502049	FULL FLOW	50% @ 20	HONDA 15400-PR3-004				2.49	63	2.00	51
	3.16	80	5.64	143	P502056	FULL FLOW	50% @ 20	MAZDA 145623802,145623802A ,RF0323802				2.50	64	2.28	58
	3.15	80	3.94	100	P502051	FULL FLOW		HONDA 15400-PH1-014, 15400-PK1-003	Yes	11-17	0.80-1.00	2.48	63	1.81	46
	3.15	80	3.15	80	P550776	FULL FLOW		KUBOTA 7000015241	Yes	10-15		2.48	63		
	3.15	80	3.98	101	P550405	FULL FLOW	99% @ 40	HINO 23304-78020				2.48	63	1.81	46
	3.18	81	3.39	86	P550162	FULL FLOW	99% @ 39	ISUZU, HONDA	Yes	11-17	0.80-1.00	2.50	64	2.11	54
M22 x 1.5	3.15	80	3.94	100	P550389	FULL FLOW	50% @ 25	ISUZU 8941145840	Yes	8-11	0.60-0.80	2.48	63	1.99	51
	3.15	80	3.17	81	P550600	FULL FLOW		HONDA 15400PL2004, 005, 305				2.94	75	2.43	62
85 mm / 2.68" Diameter Family															
3/4-16	3.31	84	4.92	125	P550078	FULL FLOW	50% @ 20	TOYOTA 15601-33010	Yes			2.47	63	2.25	57
	3.31	84	3.93	100	P550227	FULL FLOW	99% @ 45	SUBARU, PINTO, DATSUN	Yes			2.47	63	2.25	57
2 3/4-5	3.33	85	4.84	123	P552451	BYPASS		WISCONSIN RV40							
M20 x 1.5	3.28	83	2.78	71	P550726	FULL FLOW	99% @ 40	KUBOTA 15841-32430, 15841-32431		11-15	0.80-1.00	2.52	64	2.26	57
	3.43	87	3.50	89	P502076	FULL FLOW	50% @ 20	PEUGEOT 110951				3.33	85	2.81	71
93 mm / 3.54" Diameter Family															
1-12	3.66	93	5.08	129	P502068	COMBINATION		NISSAN 1520840L00, 1520820N00	Yes			2.87	73	2.00	51
	3.66	93	5.35	136	P552819	FULL FLOW	50% @ 20	DEUTZ, CLARK, HYSTER	Yes	18-23	1.30-1.60	2.81	71	2.42	61
	3.66	93	5.35	136	P555680	FULL FLOW	50% @ 20	CAT 9N-5680		18-23	1.30-1.60	2.81	71	2.42	61
	3.66	93	6.85	174	P553712	FULL FLOW	50% @ 20	CARRIER, ATLS COPCO, THERMOKING 11.3712				2.81	71	2.42	61
	3.66	93	6.85	174	P557207	FULL FLOW	50% @ 20	IHC 427207C2		7-10	0.50-0.70	2.81	71	2.42	61
	3.66	93	6.85	174	P555616	FULL FLOW	99% @ 40	IHC 675616C91, CASE	Yes			2.81	71	2.42	61
	3.67	93	6.88	175	P551297	FULL FLOW	99% @ 45	KOMATSU/KOMATSU DRESSER 6002115213	Yes	18-21	1.30-1.50	2.85	72	2.47	63
	3.66	93	7.87	200	P553771	FULL FLOW	50% @ 20	DEUTZ 1174421, CASE IH	Yes	35	2.41	2.81	71	2.42	61
	3.67	93	8.00	203	P551262	FULL FLOW		NAVISTAR 1808896C1				2.85	72	2.47	63
	3.70	94	3.75	95	P550710	FULL FLOW	99% @ 40	KOMATSU 600-211-6140	Yes	34-37	2.40-2.60	2.85	72	2.45	62
	3.69	94	6.99	178	P552411	FULL FLOW		CASE 528250R1				2.73	69	2.42	61
	3.70	94	8.30	211	P550562	FULL FLOW		LIEBHERR 5700043				2.83	72	2.48	63
	3.73	95	4.22	107	P550719	FULL FLOW	99% @ 40	IHC 3136046R93		20-24	1.40-1.70	2.78	71	2.43	62
	3.74	95	5.47	139	P559418	FULL FLOW	50% @ 20	DEUTZ 1174418	Yes	36	2.48	2.81	71	2.42	61
	3.75	95	6.99	178	P550362	FULL FLOW	99% @ 40	DEUTZ 1174419	Yes	30	2.07				
	3.74	95	8.31	211	P550317	FULL FLOW	99% @ 40	RENAULT RVI 5000670671	Yes	34-37	2.40-2.60	2.80	71	2.40	61
3.81	97	6.78	172	P558250	FULL FLOW	99% @ 40	IHC 528250R91,	Yes	11-17	0.80-1.00	2.81	71	2.42	61	
1-16	3.66	93	5.35	136	P558616	FULL FLOW	50% @ 20	CUMMINS 3903224, 3908616				2.81	71	2.42	61
	3.66	93	5.35	136	DBL7345	FULL FLOW	99% @ 15	EXTENDED SERVICE CUMMINS 4B 3.9 SERIES LUBE				2.81	71	2.42	61
	3.66	93	5.35	136	P551017	FULL FLOW	99% @ 15	CUMMINS ISB				2.83	72	2.44	62
	3.66	93	6.50	165	P502503	FULL FLOW	99% @ 15	FORD 2011 LIGHT TRUCK	Yes			2.64	67	2.44	62
	3.66	93	6.85	174	P551018	FULL FLOW	99% @ 15	CUMMINS ISC ENGINES 3934430				2.64	67	2.44	62
	3.66	93	6.85	174	P558615	FULL FLOW	50% @ 20	CUMMINS 3932217, 3908615				2.81	71	2.42	61
	3.67	93	6.87	174	P551265	FULL FLOW		DAEWOO 65055105009				2.83	72	2.46	62
	3.66	93	6.85	174	DBL7349	FULL FLOW	99% @ 15	EXTENDED SERVICE CUMMINS 4B & 6B SERIES LUBE				2.81	71	2.42	61



Spin-On Filters

Thread	OD		Length		Part No.	Part Description	Efficiency @ Micron	Primary Application	Anti-Drain Back Valve	By-Pass Valve Setting		GSKT O.D.		GSKT I.D.	
	IN	MM	IN	MM						PSI	Bar	IN	MM	IN	MM
93 mm / 3.54" Diameter Family, continued															
7/8-14	3.67	93	3.75	95	P551287	FULL FLOW	50% @ 25	CATERPILLAR 9M-8755		17-19	1.20-1.30	2.85	72	2.45	62
3/4-16	3.67	93	2.22	56	P551784	FULL FLOW		LISTER PETER 75110620				2.75	70	2.43	62
	3.66	93	3.30	84	P551042	FULL FLOW		BOBCAT 6678233				2.83	72	2.44	62
	3.66	93	3.39	86	P550939	FULL FLOW	99% @ 40	KUBOTA 1732132430		10	.70	2.83	72	2.46	62
	3.66	93	3.57	91	P550939	FULL FLOW	50% @ 21	CUMMINS C6002112110		16	1.10	2.83	72	2.46	63
	3.66	93	4.21	107	P552518	FULL FLOW	99% @ 40	DODGE 6CYL-225,V8-318, CHYRYS, FORD & OTHERS	Yes	7-10	0.50-0.70	2.81	71	2.42	61
	3.67	93	5.32	135	P169071	FULL FLOW	99% @ 22	HIGH EFFICIENCY VERSION OF P550008	Yes	8-11	0.60-0.80	2.85	72	2.47	63
3/4-16	3.66	93	5.35	136	P550008	FULL FLOW	50% @ 20	FORD, MOTORCRAFT FL1A		7-10	0.50-0.70	2.81	71	2.42	61
	3.66	93	5.35	136	P554403	FULL FLOW	50% @ 20	PERKINS 2654403, MF	Yes	7-10	0.50-0.70	2.81	71	2.41	61
	3.66	93	5.35	136	P557780	FULL FLOW	50% @ 20	ISUZU, NISSAN	Yes	18-23	1.30-1.60	2.81	71	2.42	61
	3.66	93	5.87	149	P550006	FULL FLOW	99% @ 40	MERCEDES, RVI		36	2.5	2.81	71	2.44	62
	3.66	93	6.85	174	P550299	FULL FLOW	99% @ 40	FORD D3HZ6731B, MOTORCRAFT FL788	Yes	7-10	0.50-0.70	2.81	71	2.42	61
	3.66	93	6.86	174	P554407	FULL FLOW	99% @ 48	PERKINS 2654407	Yes	8-11	0.60-0.80	2.82	72	2.48	63
	3.66	93	4.21	107	P550942	FULL FLOW	99% @ 40	KUBOTA 1540232090	Yes	34-37	2.40-2.60	2.80	71	2.48	63
	3.66	93	4.21	107	P550941	FULL FLOW	99% @ 40	CASE, DAVID BROWN, TOYOTA		18-20	1.30-1.40	2.84	72	2.47	63
	3.69	94	5.54	141	P553411	FULL FLOW	99% @ 40	ALLIS CHALMERS, WORTHINGTON, FORD	Yes	18-20	1.30-1.40	3.50	89	2.79	71
	3.74	95	3.62	92	P550318	FULL FLOW	50% @ 25	SCANIA 173171	Yes	14-20	1.00-1.40	2.81	71	2.42	61
	3.72	95	3.95	100	P550963	FULL FLOW	50% @ 20	DODGE LIGHT TRUCK	Yes	8-16	0.60-1.10	2.84	72	2.48	63
	3.66	97	3.58	91	P550939	FULL FLOW	99% @ 40	ATLAS COPCO 10300882, FORD, MACK		10 - 20	0.80-1.20	2.82	72	2.42	61
	3.81	97	3.72	95	P550939	FULL FLOW	99% @ 36	FORD, ONAN		8-11	0.60-0.80	2.82	72	2.42	61
	3.82	97	3.98	101	P550942	FULL FLOW	50% @ 10	ZETTELMEYER 2138220		36	2.48	2.80	71	2.40	61
	5/8-18	3.73	95	4.31	109	P550154	BYPASS	99% @ 45	IHC 538836R1				2.83	72	2.46
3.81		97	5.22	133	P550050	BYPASS	99% @ 45	CAT, AMC, MF, ALLIS 74512207				2.82	72	2.42	61
3.81		97	5.68	144	P550194	FULL FLOW		WISCONSIN RV38	Yes	12-15	0.80-1.00				
3.81		97	7.91	201	P553404	BYPASS	99% @ 45	CARRIER TRANSICOLD 30.00304.00				2.82	72	2.42	61
3/4-20	3.69	94	5.43	138	P552363	BYPASS	50% @ 21	THERMO KING 116228				2.83	72	2.46	63
1 1/2-16	3.70	94	5.51	140	P551352	FULL FLOW	99% @ 48	JOHN DEERE RE59754				3.76	96	3.22	82
1 1/8-16	3.66	93	6.81	173	P551348	FULL FLOW	50% @ 16	mitsubishi C45702411 , WP110				2.80	71	2.01	51
	3.66	93	6.85	174	P551019	FULL FLOW	99% @ 15	CUMMINS B SERIES				2.83	72	2.44	62
	3.66	93	6.85	174	P550428	FULL FLOW	50% @ 20	CUMMINS "98" B SERIES				2.84	72	2.44	62
	3.81	97	5.22	133	P555570	FULL FLOW	99% @ 45	CAT 8N-9586, 9N-5570				2.81	71	2.42	61
13/16-16	3.66	93	4.34	110	P550551	BYPASS		WISCONSIN RV51				3.44	87	3.10	79
	3.66	93	4.34	110	P550599	FULL FLOW		GM 6437462				2.83	72	2.46	63
	3.66	93	7.87	200	P550832	FULL FLOW	50% @ 20	GMC 6439034				3.38	86	3.04	77
	3.69	94	5.20	132	P551764	FULL FLOW		GM 6438868				3.44	87	3.10	79
	3.69	94	5.36	136	P550518	FULL FLOW	99% @ 20	AC PF2232 2001 SILVERADO V8 400 6.6L F.I.	Yes	11-17	0.80-1.00	3.48	88	3.10	79
	3.73	95	5.37	136	P166564	FULL FLOW	99% @ 22	GM CAR & TRUCK				3.45	88	3.00	76
	3.77	96	3.08	78	P550507	FULL FLOW	99% @ 22	GM LIGHT TRUCK, AC PF454, PH454	Yes			3.57	91	3.16	80
	3.78	96	5.14	131	P550964	FULL FLOW	99% @ 35	GM LIGHT TRUCK	Yes			3.38	86	3.04	77
	3.81	97	4.22	107	P550025	FULL FLOW	99% @ 40	GMC 6CYL. & V8 GAS				3.38	86	3.04	77
	3.81	97	5.12	130	P550035	FULL FLOW	50% @ 20	GM, ACPF35				3.38	86	3.04	77
	3.81	97	5.22	133	P550024	FULL FLOW	99% @ 40	ALLIS CHALMERS, CASE, IHC	Yes			2.82	72	2.42	61
	3.81	97	5.53	140	P550020	FULL FLOW	99% @ 40	JOHN DEERE AR58956, T19044		18-23	1.30-1.60	2.81	71	2.42	61



Thread	OD		Length		Part No.	Part Description	Efficiency @ Micron	Primary Application	Anti-Drain Back Valve	By-Pass Valve Setting		GSKT O.D.		GSKT I.D.	
	IN	MM	IN	MM						PSI	Bar	IN	MM	IN	MM
2 3/4-4	3.54	90	4.86	123	P558717	BYPASS		CASE A36136, HYSTER 38714, MF 835652M91							
	3.79	96	6.02	153	P552404	BYPASS	50% @ 10	OLIVER 100126ASA; WHITE 1LA5507				3.05	77	2.68	68
	3.79	96	8.13	206	P552464	FULL FLOW		OLIVER 250046, 100125ASA; WAUKESHA 119390A, K5507				3.05	77	2.68	68
M18 x 1.5	3.70	94	3.72	95	P550242	BYPASS	50% @ 25	mitsubishi ME014838	Yes	8-11	0.60-0.80	2.46	62	2.20	56
M20 x 1.5	3.52	89	3.23	82	P502092	FULL FLOW	50% @ 20	PROTON				2.44	62	1.98	50
	3.54	90	3.93	100	P502039	FULL FLOW	50% @ 20	ISUZU 8944309830				3.43	87	3.01	76
	3.66	93	3.95	100	P550933	FULL FLOW	50% @ 19	ISUZU 8-9421-7272-0				3.42	87	3.01	76
	3.64	92	4.92	125	P550412	BYPASS	50% @ 5	MAZDA SL5014V61				3.43	87	2.08	53
	3.66	93	3.39	86	P550935	FULL FLOW		CHRYSLER		8-10	0.60-0.70	2.63	67		
	3.66	93	5.35	136	P550934	FULL FLOW	99% @ 40	FORD E3TZ6731C		8-11	0.60-0.80	2.82	72	2.42	61
M22 x 1.5	3.54	90	3.18	81	P502048	FULL FLOW	50% @ 20	HONDA 15400-PA6-305				2.52	64	2.27	58
	3.64	92	5.47	139	P502072	FULL FLOW	50% @ 20	MOTORCRAFT				2.75	70		
	3.67	93	3.58	91	P550965	FULL FLOW	50% @ 20	FORD LIGHT TRUCK	Yes	15	1.03	2.81	71	2.42	61
	3.67	93	5.42	138	P550166	FULL FLOW	99% @ 45	ONAN 122-0550		17-22	1.20-1.50	2.83	72	2.46	62
	3.78	96	3.78	96	P550357	FULL FLOW		FORD 844F6716AA	Yes	10-15	0.70-1.00	3.54	90	3.03	77
	3.82	97	5.51	140	P553315	FULL FLOW		FORD 785F-6714-AA3A				2.82	72	2.45	62
M24 x 1.5	3.66	93	5.35	136	P550758	FULL FLOW	99% @ 40	JOHN DEERE RE519626, RE518977		24	1.70	2.83	72	2.44	62
	3.75	95	6.88	175	P550975	FULL FLOW		VALMET 836136342	Yes	34-37	2.40-2.60				
M26 x 1.5	3.54	90	4.92	125	P502043	COMBINATION	50% @ 20	ISUZU 8943604271				3.44	87	3.00	76
	3.58	91	4.92	125	P502058	COMBINATION	50% @ 20	DAIHATSU, ISUZU, MAZDA				3.43	87	3.00	76
	3.66	93	6.92	176	P557382	COMBINATION	99% @ 25	THERMO KING 117382,				2.81	71	2.42	61
M27 x 2	3.85	98	6.89	175	P550520	FULL FLOW		DAF 1399494				2.83	72	2.44	62
M92 x 2.5-6H	3.66	93	5.94	151	P550779	FULL FLOW	99% @ 40	JOHN DEERE RE504836							
100 mm / 3.94" Diameter Family															
1-12	3.96	101	4.92	125	P502060	FULL FLOW	50% @ 20	MAZDA TFY014302	Yes	11-17	0.80-1.00	3.92	100	3.48	88
	3.96	101	4.92	125	P550411	FULL FLOW		MAZDA 130523802		11-17	0.80-1.00	3.92	100	3.48	88
	3.98	101	5.85	149	P505956	FULL FLOW		HINO							
	4.02	102	5.91	150	P550409	FULL FLOW	50% @ 16	MAZDA SL0223802				3.92	100	3.46	88
	4.02	102	5.91	150	P502080	FULL FLOW	50% @ 20	mitsubishi 32B4000100	Yes			3.91	99	3.46	88
	4.00	102	5.92	150	P550422	FULL FLOW		HITACHI 4183853, ISUZU 8943212191	Yes	17	1.20	3.92	100	3.48	88
	4.02	102	5.91	150	P502476	FULL FLOW	99% @ 39	mitsubishi 32B4020100	Yes			3.90	99	3.46	88
M24 x 1.5	3.93	100	3.30	84	P502017	COMBINATION	50% @ 5	TOYOTA 90915-03003, 90915-30001	Yes	11-17	0.80-1.00	3.15	80		
M26 x 1.5	4.02	102	4.92	125	P502061	COMBINATION		MAZDA VSY114302				3.35	85	2.17	55
	4.02	102	5.31	135	P551343	BYPASS	50% @ 16	mitsubishi MD069782	Yes	12-16	0.80-1.00	2.87	73	1.77	45
	4.02	102	6.02	153	P550406	FULL FLOW	50% @ 16	HINO 156071480	Yes	11-17	0.80-1.00	2.87	73	2.20	56



Spin-On Filters

Thread	OD		Length		Part No.	Part Description	Efficiency @ Micron	Primary Application	Anti-Drain Back Valve	By-Pass Valve Setting		GSKT O.D.		GSKT I.D.	
	IN	MM	IN	MM						PSI	Bar	IN	MM	IN	MM
108 mm / 4.25" Diameter Family															
1-12	4.21	107	3.96	101	P502085	FULL FLOW	50% @ 20	MITSUBISHI 32A4000100	Yes	18-24	1.30-1.70	3.90	99	3.46	88
	4.25	108	5.14	131	P502032	COMBINATION	50% @ 20	ISUZU 8941432050				2.90	74	2.15	55
	4.23	107	5.79	147	P559126	FULL FLOW	99% @ 40	FORD E7HZ6731A (BRAZILIAN CAB FORWARD)		18-23	1.30-1.60	2.82	72	2.42	61
	4.25	108	6.61	168	P553871	FULL FLOW	50% @ 20	THERMOKING 11.3871				2.82	72	2.42	61
	4.27	108	8.00	203	P550319	FULL FLOW	99% @ 25	IHC 1811953C1 FOR DT/DTA360 & 466 DIESEL ENG				2.82	72	2.42	61
	4.27	108	9.09	231	P550393	FULL FLOW	99% @ 40	MERCEDES TRUCK 0031841701				2.82	72	2.44	62
	4.25	108	9.13	232	P551604	FULL FLOW	50% @ 14	FIAT 71909137, IVECO 01901604	Yes	18-20	1.30-1.40	2.81	71	2.46	62
1-16	4.28	109	5.78	147	P550152	FULL FLOW	99% @ 40	FIAT ALLIS, A.CHALMERS 4023548-3				2.83	72	2.45	62
	4.28	109	7.33	186	P552474	FULL FLOW		ALLIS CHALMERS 4037047				2.83	72	2.46	63
7/8-16	4.27	108	8.06	205	P550714	FULL FLOW	99% @ 40	WHITE 30-3068145	Yes	18-25	1.30-1.70	2.82	72		
	4.23	108	7.95	202	P559130	FULL FLOW	99% @ 40	CASEIH A62423				2.83	72	2.44	62
3/4-16	4.24	108	6.59	167	P551267	FULL FLOW	99% @ 30	NISSAN 15201Z9008				2.82	72	2.46	62
	4.26	108	7.25	184	P551603	FULL FLOW	99% @ 23	FIAT 71909101, IVECO 01901603, HESSTON	Yes	30	2.07	2.83	72	2.44	62
	4.28	109	3.77	96	P550580	FULL FLOW	99% @ 45	FORD, MASSEY FERGUSON, MPLS MOLINE	Yes	8-11	0.60-0.80	2.81	71	2.42	61
	4.40	112	5.70	145	P550226	FULL FLOW	50% @ 4	IVECO 1902047	Yes	20-23	1.30-1.80	2.83	72	2.44	62
3/4-20	4.28	109	7.89	200	P553746	BYPASS	99% @ 12	THERMO KING 11.3746				2.83	72	2.45	62
1 1/2-12	4.25	108	10.42	265	P502081	FULL FLOW	50% @ 16	MITSUBISHI 3754001101				4.02	102	3.42	87
1-1/2-16	4.23	107	5.79	147	P559127	FULL FLOW	99% @ 40	FORD E3TZ6731A, IHC 6.9L 1804442C1				3.89	99	3.55	90
	4.27	108	8.02	204	P550371	FULL FLOW	99% @ 25	NAVISTAR 1822731C1, 1814562C1 FORD F4TZ-6731-A				3.89	99	3.55	90
1 1/8-16	4.26	108	6.57	167	P550086	FULL FLOW	50% @ 20	KOMATSU 6136-51-5120		11-17	0.80-1.00	3.89	99	3.55	90
	4.24	108	6.56	167	P550708	FULL FLOW	99% @ 45	KOMATSU 6134-51-5120	Yes	27	1.86	3.94	100	3.58	91
	4.24	108	6.73	171	P551266	FULL FLOW		NISSAN FL201Z9010				4.01	102	3.60	91
	4.24	108	7.02	178	P551263	FULL FLOW		VOLVO 8477416				3.94	100	3.56	90
	4.25	108	10.24	260	P550519	FULL FLOW		M&H W11102/20							
	4.25	108	10.31	262	P554004	FULL FLOW	50% @ 20	CATERPILLAR 1R-0658, 2P-4004				3.89	99	3.55	90
	4.24	108	10.32	262	P553191	FULL FLOW	50% @ 9	MACK 485-GB-3191, RENAULT, VOLVO & ON HWY TRUCKS				3.89	99	3.55	90
	4.25	108	10.31	262	DBL7483	FULL FLOW	99% @ 15	EXTENDED SERVICE MACK/VOLVO ENGINES				3.88	99	3.55	90
	4.25	108	10.31	262	DBL7739	FULL FLOW	99% @ 15	EXTENDED SERVICE CAT ENGINES				3.88	99	3.55	90
	4.25	108	10.32	262	P551807	FULL FLOW	99% @ 21	CATERPILLAR 1R1807, MACK 485GB3236				3.89	99	3.55	90
	4.23	107	5.79	147	P559128	FULL FLOW	99% @ 40	CAT 9N-6007				3.94	100	3.55	90
	4.33	110	6.38	162	P550420	FULL FLOW	50% @ 20	HITACHI 4296675				4.13	105	3.74	95
	4.33	110	6.73	171	P502088	FULL FLOW	50% @ 16	NISSAN 15201Z9000, 15201Z9002, 15201Z9003				3.90	99	3.46	88
	4.33	110	10.08	256	P551102	FULL FLOW	50% @ 20	DEUTZ 1174420	Yes	30-42	2.10-2.80	4.02	102	3.62	92
	4.33	110	10.20	260	P550490	FULL FLOW		SCANIA 1117285				4.09	104	3.66	93
	4.45	113	6.73	171	P502083	FULL FLOW	99% @ 48	MITSUBISHI 3743802400				2.93	74	2.54	65
1 3/8-16	4.29	109	10.36	263	P550425	BYPASS	99% @ 35	VOLVO 4775565				3.99	101	3.63	92
M20 x 1.5	4.13	105	3.15	80	P550383	FULL FLOW		ISUZU 8941145850				3.92	100	3.52	89
	4.20	107	4.98	126	P550067	FULL FLOW	50% @ 16	MITSUBISHI ME014833, ME004099				3.90	99	3.46	88
	4.24	108	5.62	143	P551264	FULL FLOW		KOMATSU/KOMATSU DRESSER Z14020F105		20	1.38	3.94	100	3.56	90
	4.33	110	6.38	162	P551257	FULL FLOW	99% @ 5	ISUZU X13201012				4.13	105	3.74	95



Thread	OD		Length		Part No.	Part Description	Efficiency @ Micron	Primary Application	Anti-Drain Back Valve	By-Pass Valve Setting		GSKT O.D.		GSKT I.D.	
	IN	MM	IN	MM						PSI	Bar	IN	MM	IN	MM
M24 x 1.5	4.13	105	4.81	122	P550597	COMBINATION		TOYOTA 9091503006, 9091530002				3.15	80	2.80	71
M26 x 1.5	4.21	107	5.90	150	P502008	COMBINATION	50% @ 20	MITSUBISHI ME013307, ME013343		11-17	0.80-1.00	2.87	73	2.19	56
M30 x 1.5	4.25	108	5.51	140	P550707	FULL FLOW	99% @ 48	TOYOTA 15601-68010	Yes	18-21	1.30-1.50	3.37	86	2.95	75
	4.23	107	6.61	168	P559129	FULL FLOW	99% @ 30	ROLLS ROYCE CV2473		18-21	1.30-1.50	4.05	103	3.42	87
M30 x 2	4.25	108	5.62	143	P502222	FULL FLOW	50% @ 16	FIAT 74741272	Yes			2.83	72	2.44	62
	4.27	108	9.00	229	P550712	FULL FLOW	99% @ 35	FIAT ALLIS 74744707		18-21	1.30-1.50	3.96	101	3.59	91
	4.29	109	9.06	230	P550342	FULL FLOW	50% @ 12	IVECO 1902102	Yes	36	2.48	4.06	103	3.62	92
	4.45	113	8.92	227	P550639	FULL FLOW	50% @ 14								
M32 x 1.5	4.25	108	8.77	223	P502093	COMBINATION	50% @ 20	CATERPILLAR 517950		25-31	1.80-2.20	4.02	102	3.62	92
118 mm / 4.65" Diameter Family															
1 1/2-12	4.65	118	6.22	158	DBL7947	FULL FLOW	99% @ 15	EXTENDED SERVICE DETROIT DIESEL ENGINES				4.31	109	3.84	98
	4.65	118	8.09	205	P550596	FULL FLOW	99% @ 25	HITACHI 4448336		20	1.40	4.33	110	3.85	98
	4.65	118	10.24	260	P551670	FULL FLOW	50% @ 14	CUMMINS 3313279, DET DIESEL ENG				4.32	110	3.85	98
	4.65	118	10.24	260	DBL7670	FULL FLOW	99% @ 15	EXTENDED SERVICE CUMMINS AND DETROIT DIESEL ENGINES				4.31	109	3.84	98
	4.65	118	10.24	260	P167670	FULL FLOW	99% @ 15	MERCEDES 23518524				4.31	109	3.84	98
	4.67	119	6.28	159	P550947	FULL FLOW	50% @ 14	GMC 25011106, DETROIT DIESEL ENGINES				4.32	110	3.85	98
	4.67	119	7.85	199	P551381	FULL FLOW	50% @ 20	HINO 15607-1381				4.32	110	3.85	98
	4.67	119	8.94	227	P550671	FULL FLOW	50% @ 14	CUMMINS				4.32	110	3.85	98
	4.86	123	5.87	149	P550973	COMBINATION	50% @ 20	ISUZU 8970492820, FULL FLOW BYPASS				4.32	110	3.85	98
	4.88	124	4.72	120	P502042	COMBINATION	50% @ 16	ISUZU 8970967770, 2906548000, 97148270		11-17	0.80-1.00	4.59	116	3.86	98
4.88	124	4.72	120	P502046	COMBINATION	50% @ 20	ISUZU 8970967770, 8943381811				4.59	116	3.86	98	
1 1/2-16	4.65	118	7.83	199	P552050	FULL FLOW	99% @ 39	HINO 156072050				4.32	110	3.85	98
	4.65	118	7.83	199	P551441	FULL FLOW	99% @ 21	HINO 156072190				4.09	104	3.86	98
	4.65	118	11.73	298	DBL7405	FULL FLOW	99% @ 15	EXTENDED SERVICE CAT ENGINES				4.32	110	3.85	98
	4.67	119	11.75	298	P554105	FULL FLOW	50% @ 20	4-5/8" DIA. VERSION OF CATERPILLAR #2P4005				4.32	110	3.85	98
1 1/8-16	4.50	114	8.50	216	P550073	FULL FLOW	50% @ 25	NISSAN 15208-Z9001				3.34	85	2.95	75
1 3/4-12	4.66	118	11.26	286	P551145	FULL FLOW	99% @ 20	NAVISTAR 1889124C91				4.33	110	3.86	98
1 3/8-16	4.66	118	9.91	252	P550421	FULL FLOW	99% @ 50	HITACHI 4266385, ISUZU 11324010521				4.33	110	3.85	98
	4.65	118	10.24	260	P550777	BYPASS	50% @ 14	CUMMINS 330432, 3313289				4.32	110	3.85	98
1 5/8-12	4.65	118	10.24	260	DBL3998	FULL FLOW	99% @ 15	EXTENDED SERVICE DETROIT DIESEL SERIES 60 ENGINES				4.31	109	3.84	98
	4.65	118	10.24	260	P551016	FULL FLOW	99% @ 15	DETROIT DIESEL SERIES 60 ENGINES				4.31	109	3.84	98
	4.65	118	10.24	260	P552100	FULL FLOW	99% @ 30	DET. DIESEL 50 & 60 SERIES ENGINES				4.32	110	3.85	98
	4.66	118	10.24	260	P551146	FULL FLOW	99% @ 20	NAVISTAR 1889119C91				4.33	110	3.86	98
2 1/4-12	4.65	118	8.94	227	P553548	COMBINATION	99% @ 15	CASE IH J919562				4.68	119	4.00	102
	4.65	118	11.70	297	P553000	COMBINATION	99% @ 22	CUMMINS ENGINES				4.68	119	4.00	102
	4.65	118	11.75	298	DBL7300	COMBINATION	99% @ 15	EXTENDED SERVICE CUMMINS ENGINES				4.68	119	4.00	102
M52 x 1.5	4.66	118	11.70	297	P550595	COMBINATION	99% @ 22	JOHN DEERE VENTURI COMBO				4.68	119	4.01	102
M90 x 2.0	4.79	122	11.85	301	P554560	FULL FLOW	99% @ 15	CUMMINS QSK ENGINES				4.68	118	3.85	98
M95 x 2.0	4.65	118	13.67	347	P552025	COMBINATION	99% @ 30	IH DT466 2004 ON				4.68	119	4.00	102



Spin-On & Cartridge Filters

Thread	OD		Length		Part No.	Part Description	Efficiency @ Micron	Primary Application	Anti-Drain Back Valve	By-Pass Valve Setting		GSKT O.D.		GSKT I.D.	
	IN	MM	IN	MM						PSI	Bar	IN	MM	IN	MM
118 mm / 4.65" Diameter Family, continued															
M95 x 2.5	4.65	118	11.70	297	DBL7900	FULL FLOW	99% @ 15	EXTENDED SERVICE CUMMINS ISX				4.68	119	4.00	102
	4.65	118	11.70	297	P550949	FULL FLOW	99% @ 30	OEM EFFICIENCY CUMMINS ISX				4.68	119	4.00	102
	4.66	118	11.70	297	P559000	FULL FLOW	99% @ 22	HIGH EFFICIENCY CUMMINS ISX				4.68	119	4.00	102
	4.67	119	11.70	297	DBL2501	FULL FLOW	99% @ 15	EXTENDED SERVICE CUMMINS ISX				4.64	118	3.97	101

136 mm / 5.36" Diameter Family															
1 1/2-12	5.06	129	6.72	171	P558329	FULL FLOW	50% @ 25	JOHN DEERE AR98329							
1 1/2-16	5.00	127	6.85	174	P553634	FULL FLOW	50% @ 20	MICH FP, JOHN DEERE AR43634				5.05	128	4.71	120
	5.32	135	9.61	244	P550788	FULL FLOW	99% @ 21	CATERPILLAR C13 ENGINES				4.31	109	3.92	99
	5.33	135	12.13	308	P551402	FULL FLOW	50% @ 14	DD 2000 SERIES AND MARINE VERSION 4000 SERIES		31-38	2.20-2.70	4.31	109	3.92	100
	5.32	135	12.13	308	P551808	FULL FLOW	99% @ 21	CATERPILLAR 1R1808				4.31	109	3.92	100
	5.33	135	12.13	308	P554005	FULL FLOW	99% @ 39	CAT 1R-0716, 2P-4005, STGR, SULLAIR				4.31	109	3.92	100
	5.35	136	9.68	246	P554206	FULL FLOW	99% @ 40	IHC 684206C1				4.29	109	3.89	99
	5.55	141	12.20	310	P550341	FULL FLOW	50% @ 25	DAF 267714		32-40	2.20-2.80	4.37	111	3.94	100
1 1/8-16	5.56	141	6.00	152	P550157	FULL FLOW		FORD EDNN6714AA				4.37	111	3.97	101
13/16-16	5.44	138	5.44	138	P550188	FULL FLOW	99% @ 45	CUMMINS 170200		8-10	0.60-0.70				
M36 x 1.5	5.12	130	8.66	220	P552562	COMBINATION	99% @ 45	mitsubishi ME074013				4.21	107	3.86	98
	5.33	135	12.13	308	DBL7367	FULL FLOW		EXTENDED SERVICE NAVISTAR 1819452C1				4.29	109	3.89	99
	5.33	135	12.10	308	P550512	FULL FLOW	99% @ 21	DETROIT DIESEL 5241840301		31-38	2.14-2.62	4.31	109	3.92	100
	5.32	136	12.10	307	P550367	FULL FLOW	50% @ 14	NAVISTAR 1819452C1		26-30	1.80-2.10	4.35	110	3.95	100
M42 x 2	5.51	140	11.89	302	P550452	FULL FLOW		DAF 1310901, FLEETGUARD LF3737 & LF3773		36	2.48	4.37	111	3.97	101
M45 x 1.5	5.33	135	12.13	308	P551400	FULL FLOW	50% @ 14	DETROIT DIESEL 4000 SERIES ENGINE				4.31	109	3.92	100
M60 x 3	5.48	139	6.62	168	P550356	COMBINATION		FORD 826F6714		10-15	0.70-1.00				

Cartridge Lube Filters

Outer Dia.		Inner Dia.		Length		Part No.	Part Description	Efficiency @ Micron	Primary Application
IN	MM	IN	MM	IN	MM				
1.97	50	0.46	12	1.48	38	P552421	CARTRIDGE FULL FLOW		HONDA 15410-KF0-315, 15412-KF0-000
2.00	51	0.81	21	2.12	54	P555400	CARTRIDGE FULL FLOW		LISTER, PETTER
2.09	53	0.77	20	3.86	98	P552361	CARTRIDGE FULL FLOW		GMC 25177917
2.30	58	0.44	11	4.63	118	P551294	CARTRIDGE FULL FLOW		CASE IH 376373R91
2.36	60	0.63	16	3.94	100	P550744	CARTRIDGE		MERCEDES-BENZ A0002690321
2.35	60	0.70	18	3.90	99	P550396	CARTRIDGE FULL FLOW	50% @ 25	MERCEDES 001844901, 00184425
2.44	62	0.86	21	6.20	157	P550521	CARTRIDGE FULL FLOW		MERCEDES 1041800109
2.48	63	1.08	27	3.53	90	P552419	CARTRIDGE FULL FLOW		FORD DOHZ-3C602-B; INTERNATIONAL 507809-C91
2.50	64	1.22	31	4.53	115	P550564	CARTRIDGE FULL FLOW		MERCEDES 6111800009
2.50	64	1.22	31	5.91	150	P550633	CARTRIDGE		VOLVO 1521527 / M&H HU721
2.59	66	1.22	31	4.52	115	P550798	CARTRIDGE	99% @ 39	MERCEDES 0001802609
2.75	70	1.31	33	3.33	85	P551291	CARTRIDGE FULL FLOW		LEYLAND 134311
2.75	70	1.31	33	6.00	152	P550183	CARTRIDGE FULL FLOW	99% @ 36	FORD E1ADKN18662A
2.79	71	1.22	31	3.74	95	P550797	CARTRIDGE	99% @ 38	MERCEDES 6421800009
2.83	72	0.83	21	4.47	114	P550184	CARTRIDGE FULL FLOW	50% @ 20	FORD A730X6731TA
2.85	72	1.30	33	5.39	137	P502193	CARTRIDGE FULL FLOW	50% @ 20	ISUZU
2.85	72	1.30	33	5.39	137	P550052	CARTRIDGE FULL FLOW		MASSEY FERGUSON 101811M91, 1881840M1, 894976M91



Cartridge Filters

Outer Dia.		Inner Dia.		Length		Part No.	Part Description	Efficiency @ Micron	Primary Application
IN	MM	IN	MM	IN	MM				
2.87	73	0.93	24	4.02	102	P505978	CARTRIDGE		NISSAN 15208-2W200
2.90	74	1.12	28	5.53	140	P552382	CARTRIDGE FULL FLOW		INTERNATIONAL 406669-R1 406705-R91
2.97	75	1.07	27	5.64	143	P551296	CARTRIDGE FULL FLOW	99% @ 30	CASE IH A40902
2.98	76	0.78	20	4.07	103	P551279	CARTRIDGE FULL FLOW		CHRYSLER 1634447
3.03	77	1.02	26	8.19	208	P550927	CARTRIDGE FULL FLOW	99% @ 45	CATERPILLAR 9T-9054
3.11	79	0.75	19	9.37	238	P550311	CARTRIDGE FULL FLOW	50% @ 10	LEYLAND 602426
3.09	79	1.03	26	1.56	40	P552402	CARTRIDGE FULL FLOW		CASE A22279; INTERNATIONAL 133205-R91
3.11	79	1.38	35	9.04	230	P550165	CARTRIDGE FULL FLOW		CAT, LINK BELT 9F6742, LEROI
3.11	79	1.56	40	5.35	136	P502203	CARTRIDGE FULL FLOW	50% @ 20	NISSAN 1520876225
3.12	79	1.83	46	9.00	229	P550816	CARTRIDGE FULL FLOW	50% @ 20	CAT 4J-0816
3.22	82	1.50	38	7.89	200	P550451	CARTRIDGE		M.A.N. 51055040096
3.26	83	0.48	12	7.58	193	P550181	CARTRIDGE	99% @ 20	IHC 376375R91
3.27	83	0.83	21	5.16	131	P550767	CARTRIDGE FULL FLOW		MERCEDES OM SERIES ENGINES
3.27	83	0.83	21	7.60	193	P550764	CARTRIDGE FULL FLOW		MERCEDES, M.A.N., CLAAS
3.27	83	0.94	24	5.12	130	P550766	CARTRIDGE FULL FLOW		MERCEDES 3661840225
3.24	83	1.41	36	6.65	169	P550563	CARTRIDGE FULL FLOW		MERCEDES 6061840125
3.27	83	1.49	38	6.36	161	P552422	CARTRIDGE FULL FLOW		BMW 11421745390 11421745391
3.27	83	1.59	40	5.80	147	P550768	CARTRIDGE FULL FLOW	99% @ 40	MERCEDES 0001801609
3.27	83	2.00	51	8.24	209	P550761	CARTRIDGE FULL FLOW	50% @ 15	MERCEDES 0001801709
3.26	83	2.20	56	7.59	193	P550763	CARTRIDGE FULL FLOW		METAL FREE LUBE
3.27	83			5.39	137	P550766	CARTRIDGE FULL FLOW		MERCEDES, DEMAG, LIEBHERR, O&K, RVI, CLAAS
3.25	83			7.13	181	P550528	CARTRIDGE FULL FLOW	99% @ 25	FORD 3C3Z6731AA F SERIES PICKUP
3.31	84	0.65	17	5.63	143	P550015	CARTRIDGE FULL FLOW	50% @ 16	ISUZU 9885111940
3.31	84	0.75	19	4.21	107	P550220	CARTRIDGE FULL FLOW		SCANIA 1329876, 1381235
3.30	84	0.93	24	7.50	190	P550315	CARTRIDGE FULL FLOW		MERCEDES 3661800009
3.35	85	1.57	40	5.63	143	P502194	CARTRIDGE FULL FLOW	50% @ 16	ISUZU 13240085,
3.34	85	1.62	41	6.50	165	P555088	CARTRIDGE FULL FLOW	99% @ 38	JOHN DEERE AT15088T, PURO R14
3.37	86	1.13	29	4.25	108	P552465	CARTRIDGE		JOHN DEERE AH1081R
3.47	88	0.43	11	7.61	193	P552471	CARTRIDGE FULL FLOW		MERCEDES-BENZ 6171840025, 6171840125
3.52	89	0.69	18	4.16	106	P550179	CARTRIDGE	50% @ 10	CASE 08152AB
3.47	89	0.94	24	5.53	141	P550186	CARTRIDGE	99% @ 20	IHC 355009R91
3.50	89	1.34	34	3.78	96	P551285	CARTRIDGE FULL FLOW		PERKINS 101606
3.56	90	1.28	33	5.69	145	P550141	CARTRIDGE FULL FLOW	50% @ 20	JOY, GMC 5576054, 5574540
3.54	90	1.92	49	4.09	104	P502202	CARTRIDGE FULL FLOW	50% @ 20	ISUZU 1878103720
3.58	91	0.47	12	6.42	163	P550361	CARTRIDGE COMBINATION		MERCEDES 6011800009
3.59	91	1.28	33	6.37	162	P552415	CARTRIDGE FULL FLOW		GMC 5573976
3.62	92	0.51	13	5.83	148	P550359	CARTRIDGE FULL FLOW		ROLLS ROYCE OE12448
3.62	92	0.69	18	4.33	110	P502179	CARTRIDGE FULL FLOW	50% @ 20	MITSUBISHI 3134012030
3.62	92	0.69	18	6.30	160	P502180	CARTRIDGE FULL FLOW	50% @ 20	MITSUBISHI 3144012030
3.63	92	1.31	33	7.88	200	P552375	CARTRIDGE SOCK		OLIVER 156149AS; WAUKESHA 493009; WHITE 872946
3.75	95	1.04	26	5.94	151	P550092	CARTRIDGE FULL FLOW	99% @ 25	AC, CASE, CAT, CLARK, FTGD LF503
3.74	95	1.91	49	7.05	179	P502225	CARTRIDGE FULL FLOW	50% @ 16	LEYLAND 11K243
3.78	96	1.10	28	5.96	151	P552458	CARTRIDGE FULL FLOW		CASE D45378, G33058, A60524, A61234
3.78	96	1.10	28	6.09	155	P552455	CARTRIDGE FULL FLOW		CASE D45378, G33058, A60524, A61234
3.82	97	1.35	34	4.41	112	P550185	CARTRIDGE FULL FLOW	50% @ 20	MASSEY FERGUSON 1852331M1
3.82	97	1.73	44	5.74	146	P550076	CARTRIDGE		NISSAN 15274-99428
3.82	97			5.80	147	P574862	CARTRIDGE		MERCEDES 900 SERIES ENGINES
3.83	97			5.80	147	P574863	CARTRIDGE		NAVISTAR MAXXFORCE ENGINES



Cartridge Filters

Outer Dia.		Inner Dia.		Length		Part No.	Part Description	Efficiency @ Micron	Primary Application
IN	MM	IN	MM	IN	MM				
Cartridge Lube Filters									
3.87	98	0.49	13	4.58	116	P550287	CARTRIDGE		MACK 57GC2187
3.87	98	0.64	16	4.58	116	P550286	CARTRIDGE FULL FLOW		MACK 57GC2134
3.84	98	7.00	178			P552206	CARTRIDGE		MACK ASET
3.91	99	0.57	15	4.37	111	P550203	CARTRIDGE FULL FLOW	99% @ 20	FIAT ALLIS, CASE, CLARK, MF, HYSTER, GALION
3.89	99	0.66	17	5.67	144	P550074	CARTRIDGE		NISSAN 15274-Z9029
3.93	100	0.87	22	4.81	122	P551475	CARTRIDGE FULL FLOW	99% @ 40	CASE A21475, ALLIS CHALMERS
3.94	100	1.56	40	7.19	183	P502206	CARTRIDGE FULL FLOW	50% @ 16	NISSAN 1527499128
3.94	100	1.73	44	7.24	184	P550077	CARTRIDGE FULL FLOW	50% @ 16	NISSAN 15274-90225
3.98	101	0.65	17	7.68	195	P550070	CARTRIDGE FULL FLOW	50% @ 25	mitsubishi ME034481
3.98	101	1.10	28	9.25	235	P550068	CARTRIDGE FULL FLOW	50% @ 25	mitsubishi ME021254
3.97	101	1.20	30	9.21	234	P502183	CARTRIDGE FULL FLOW		mitsubishi ME021073
3.98	101	1.27	32	2.78	71	P551761	CARTRIDGE FULL FLOW		CASE 902125
3.98	101	1.63	41	9.29	236	P550484	CARTRIDGE FULL FLOW	50% @ 20	CAT 1R-0659, 4W-4840, KOMATSU 6610-53-5120
4.00	102	0.56	14	5.00	127	P550170	CARTRIDGE		FRAM F4
4.00	102	0.56	14	5.00	127	P550171	CARTRIDGE		FRAM F21
4.02	102	0.55	14	8.00	203	P550117	CARTRIDGE	99% @ 20	CLARK EUCLID GMC 5572425 (MILITARY SEN.)
4.03	102	0.66	17	4.67	119	P551277	CARTRIDGE		DELUXE WD30
4.02	102	1.76	45	9.92	252	P550629	CARTRIDGE		SCANIA 164 SERIE, SCANIA MARINE ENGINES DI SERIES
4.06	103	1.62	41	5.50	140	P553335	CARTRIDGE FULL FLOW	99% @ 40	IHC, GALION, HOUGH, TOWMOTOR
4.06	103			5.73	146	P550952	CARTRIDGE	50% @ 17	MANN & HUMMEL ZR905Z, DAF 1643072
4.09	104	0.59	15	5.67	144	P550062	CARTRIDGE FULL FLOW	50% @ 16	HITACHI 4507886
4.10	104	0.59	15	9.13	232	P550059	CARTRIDGE FULL FLOW	50% @ 16	HITACHI 4505384
4.09	104	1.26	32	6.69	170	P550080	CARTRIDGE FULL FLOW	50% @ 16	HINO 6071-2104-40
4.09	104	1.26	32	7.09	180	P550379	CARTRIDGE FULL FLOW	50% @ 25	HINO 156071560
4.09	104	1.92	49	6.30	160	P550010	CARTRIDGE FULL FLOW	50% @ 20	HINO 15607-1090
4.17	106	0.59	15	4.17	106	P550017	CARTRIDGE FULL FLOW	50% @ 25	ISUZU 9885132630
4.17	106	0.59	15	7.30	185	P550018	CARTRIDGE FULL FLOW	50% @ 16	ISUZU 9885132641
4.25	108	1.25	32	16.38	416	P552427	CARTRIDGE SOCK		WINSLOW W1645T
4.30	109	1.45	37	8.90	226	P550132	CARTRIDGE FULL FLOW	99% @ 30	DET. DIESEL ENG W/CARTRIDGE LUBE
4.29	109	7.44	189			P552231	CARTRIDGE		MACK E7
4.33	110	0.75	19	7.56	192	P550378	CARTRIDGE FULL FLOW	50% @ 25	mitsubishi ME034605
4.33	110	2.04	52	8.11	206	P502205	CARTRIDGE FULL FLOW	50% @ 16	NISSAN 1527499025
4.38	111	1.44	37	5.75	146	P550147	CARTRIDGE SOCK	99% @ 40	GMC 5574978
4.38	111	1.59	40	31.00	787	P550614	CARTRIDGE	95% @ 15	WAUKESHA 168660
4.37	111	3.62	92	9.56	243	P552469	CARTRIDGE FULL FLOW		JOHN DEERE AT45422
4.41	112	2.22	56	5.91	150	P550630	CARTRIDGE FULL FLOW		DAF 75CF, DAF 85CF, DAF 95 XF
4.44	113	2.31	59	8.66	220	P550812	CARTRIDGE	99% @ 38	ENERGETICS, DIRECT BONDING, DAF 1643070
4.44	113	2.67	68	8.66	220	P550661	CARTRIDGE		DAF 85CF AND XF95
4.50	114	1.45	37	16.00	406	P552428	CARTRIDGE SOCK		WAUKESHA 167602B
4.47	114	1.75	44	9.06	230	P558462	CARTRIDGE FULL FLOW		IHC 268462R91, CUMMINS 104428
4.48	114	2.84	72	10.83	275	P502184	CARTRIDGE FULL FLOW	50% @ 16	mitsubishi 68937310012
4.53	115	2.24	57	7.68	195	P554925	CARTRIDGE FULL FLOW		M.A.N. 81.05504.0025
4.57	116	2.12	54	12.68	322	P550071	CARTRIDGE FULL FLOW	50% @ 25	mitsubishi ME064289
4.59	117	0.75	19	4.87	124	P551014	CARTRIDGE FULL FLOW		FORD C5TE6744A
4.59	117	2.25	57	7.00	178	P550174	CARTRIDGE FULL FLOW	99% @ 18	IHC 213445R91



Outer Dia.		Inner Dia.		Length		Part No.	Part Description	Efficiency @ Micron	Primary Application
IN	MM	IN	MM	IN	MM				
4.64	118	1.78	45	11.77	299	P550453	CARTRIDGE		MERCEDES A5411840225
4.70	119	2.16	55	7.60	193	P558425	CARTRIDGE FULL FLOW		MERCEDES 4011840025
4.75	121	2.09	53	10.35	263	P551005	CARTRIDGE	50% @ 17	DETROIT A4721800109 (DD15)
4.76	121	1.50	38	7.44	189	P550613	CARTRIDGE FULL FLOW	99% @ 48	CUMMINS 173174
4.76	121	2.20	56	5.67	144	P550765	CARTRIDGE FULL FLOW		M.A.N. 51.05504.0098
4.76	121	2.20	56	9.60	244	P550041	CARTRIDGE FULL FLOW	50% @ 20	MERCEDES BENZ 001 1843825, M.A.N.
4.76	121	2.24	57	9.76	248	P550769	CARTRIDGE FULL FLOW	99% @ 30	MERCEDES 0001802109
4.76	121	2.24	57	8.05	205	P551108	CARTRIDGE	99% @ 25	NAVISTAR 3006874C91, MAXX FORCE ENGINES 2007-2009
4.80	122	0.67	17	8.62	219	P502190	CARTRIDGE FULL FLOW	50% @ 5	HINO 15607-1351
4.81	122	0.66	17	8.86	225	P550058	CARTRIDGE		HINO 156071010
4.80	122	0.67	17	9.80	249	P502191	CARTRIDGE FULL FLOW	50% @ 5	HINO 156071341, 15607-1340
4.84	123	0.79	20	5.43	138	P502186	CARTRIDGE FULL FLOW	50% @ 20	TOYOTA
4.84	123	2.25	57	8.86	225	P553925	CARTRIDGE FULL FLOW	99% @ 36	MERCEDES BENZ 0011843925
5.06	127	0.07	2	12.13	305	P552377	CARTRIDGE FULL FLOW		NUGENT LUBE BAG REPLACEMENT CARTRIDGE
5.00	127	0.69	18	7.88	200	P551781	CARTRIDGE		WAUKESHA 73759B
5.00	127	0.77	19	8.22	209	P552462	CARTRIDGE FULL FLOW		Ford B8C-6731-A
5.00	127	1.50	38	9.62	244	P550516	CARTRIDGE FULL FLOW	50% @ 20	CUMMINS 158139
5.04	128	0.61	15	6.30	160	P550021	CARTRIDGE FULL FLOW	50% @ 25	NISSAN 15274-99329
5.04	128	0.79	20	7.91	201	P550380	CARTRIDGE FULL FLOW	50% @ 25	ISUZU 1878103141
5.04	128	2.22	56	9.10	231	P550087	CARTRIDGE FULL FLOW		KOMATSU 6610-50-5100
5.02	128	2.26	57	5.59	142	P550066	CARTRIDGE FULL FLOW	50% @ 20	MITSUBISHI 31240-53054
5.06	129	2.94	75	9.00	229	P552380	CARTRIDGE FULL FLOW		INTERNATIONAL 623017-C1
5.07	129	3.34	85	9.00	229	P166481	CARTRIDGE FULL FLOW	99% @ 22	CAT 5S-0485
5.08	129	3.37	86	8.94	227	P550485	CARTRIDGE FULL FLOW	50% @ 14	CAT 1R-0721, 5S-0485, HYSTER 75669
5.12	130	0.59	15	9.17	233	P550034	CARTRIDGE FULL FLOW	50% @ 5	NISSAN 15274-99227
5.12	130	0.59	15	11.79	299	P550065	CARTRIDGE KIT	99% @ 48	MITSUBISHI ME064356
5.51	140	1.34	34	7.60	193	P502200	CARTRIDGE FULL FLOW	50% @ 20	ISUZU 1132401170
6.01	153	3.50	89	14.50	368	P551336	CARTRIDGE FULL FLOW	50% @ 25	FLEETLIFE FP614-40
6.30	160	0.28	7	5.20	132	P551345	CARTRIDGE	50% @ 5	HITACHI 4231195
6.30	160	0.67	17	10.51	267	P550423	CARTRIDGE		HITACHI 4225367
6.50	165	1.47	37	29.38	746	P550636	CARTRIDGE	99% @ 35	P22 RR & MARINE
6.50	165	1.69	43	7.56	192	P551344	CARTRIDGE		HITACHI 4208241
6.50	165	6.50	165	13.00	330	P550381	CARTRIDGE		ISUZU 1878100501
6.50	165	11.02	280	11.02	280	P550382	CARTRIDGE		ISUZU 1878102390
6.50	165	11.02	280	12.95	329	P550384	CARTRIDGE	50% @ 5	ISUZU 1132400560
6.50	165	3/8-24		8.75	222	P552041	CARTRIDGE		ISUZU/GMC CAB FORWARD HOUSING
6.75	171	2.47	63	17.75	451	P552414	CARTRIDGE SOCK		WHITE 673374
7.42	188	2.63	67	10.00	254	P557500	CARTRIDGE FULL FLOW	50% @ 20	CAT 7N-7500
7.42	188	3.43	87	13.38	340	P554136	CARTRIDGE FULL FLOW	50% @ 20	CAT 1W-4136
7.64	194	4.65	118	6.71	170	P502223	CARTRIDGE FULL FLOW	50% @ 20	MANN H20211
7.72	196	0.86	22	10.06	256	P550500	CARTRIDGE	50% @ 5	500 SERIES BYPASS
7.72	196	0.86	22	15.06	383	P550750	CARTRIDGE	50% @ 5	750 SERIES CARTRIDGE BYPASS
7.72	196	0.86	22	15.06	383	P550751	CARTRIDGE	50% @ 5	750 SERIES PREMIUM BYPASS
7.87	200	0.86	22	10.03	255	P550493	CARTRIDGE		CUMMINS 106621



Lube Filtration

Lube Filters for Cummins® ISX Engines



Full-Flow Lube Filters for Cummins® ISX Engines

Every oil filter needs to effectively balance three characteristics: efficiency (contaminant removal), capacity (contamination holding ability) and restriction (resistance to oil flow). Donaldson full-flow lube filters process the entire regulated oil flow through our pleated elements, even in cold temperatures – meaning your engine receives critical lubrication protection. Two-stage stacked disc filters allow only a portion of the flow to pass through the high-efficiency stage – which means more contaminant can pass on to the engine.

That's precisely why Donaldson recommends full-flow lube filters that strike the right balance for Cummins ISX and other heavy-duty engines. Donaldson filters deliver:

- Ultra-high efficiency on fine particulate and oil degradation (sludge),
- Higher contaminant holding capacity, and
- Minimum oil flow restriction.

Donaldson offers three different lube filters for ISX engines that keep oil cleaner by capturing more contaminants that can cause engine wear. Choose the filter that best fits your requirements.

OEM Efficiency

High Efficiency

STANDARD SEALS

HEAVY-DUTY SEALS



P550949

OEM Efficiency

Reliable contaminant capture and capacity (life). If you've experienced filter plugging due to excessive sludge caused by soot or coolant contamination – this is the filter for you.

- Efficiency: >99% @ 30µm
- 35% lower oil flow restriction than LF9080

CROSSESTO:

Cummins 2882674 / Fleetguard LF9080

Tested per ISO 4548/12 and ISO 3968.



P559000

High Efficiency

Increased levels of contamination capture combined with good capacity. Offers a higher level of engine protection than the OEM standard option.

- Efficiency: 99% @ 15µm
- 13% lower oil flow restriction than LF9080



DBL7900

(ELF7900)

High Efficiency with Heavy-Duty, Long-Life Seals

If your primary concern is engine protection – this premium filter will deliver with durable seals and heavy-duty potting materials to withstand extreme conditions and hot oil temperatures.

- Efficiency: 99% @ 15µm
- 40% lower oil flow restriction than LF9031

Cummins 4906633 / Fleetguard LF9031

Cummins® is a registered trademark of Cummins, Inc.

See brochure F113026 for further performance information.

www.donaldson.com/en/engine/support/datalibrary/084768.pdf



Overview	110-113
Diesel Engine Coolant Filtration	110
Diesel Coolant Trends & Changes	110
Typical Coolant Filtration System	111
Coolant Filters & Design Features.....	112
Filter Media	113
Extended Service Coolant Filtration	114
Donaldson Blue™ Filters	114
Filtration Systems – Filter & Head Designs	115
Coolant Filters.....	116
Coolant Hoses.....	117
SCA/SCA+ Chemical Differences.....	117
Coolant Additives	118
Australia Coolant.....	119
Cooling System Maintenance.....	120-121
Test Strip Kit	120
Service intervals (flush/recharge).....	120
Proper Steps for Spin-on Coolant Replacements	121
Cooling System Problems.....	122



Diesel Engine Coolant Filtration

It is estimated that 40 - 50% of engine down-time is due to coolant system failure. Coolant system failure is avoidable. With today's diesel engines putting out more heat, cooling system care has become even more important than before. Your engine coolant battles rust, scale formation, acidity, foaming, silicate drop out and debris while it works to transfer heat and maintain the right operating conditions for optimal fuel economy.

Two filtration solutions are available for light and heavy EGR engines with SCR emissions devices. OEMs using heavy EGR coolant systems will see increased thermal cycling and accelerated coolant additive depletion. Coolant conditions may need to be checked frequently to ensure proper coolant chemical balance.

It's critical that you understand the exact make-up of coolant in your engine. The type of chemical is very specific to the job and operating environment.

Coolant System Considerations:

- Do you have traditional coolant that will require traditional supplemental coolant additives?
- Do you have an organic acid based coolant?
- Do you have an extended-service traditional coolant blend?

As you weigh your options, consider selecting a fully formulated antifreeze/coolant that meets either truck maintenance regulations for your region (U.S. Truck Maintenance Council (TMC) RP 329 or RP330 specifications). New glycerin formulae that meet the specifications use non-toxic glycerin derived from renewable sources that will effectively extend service intervals and provide ultimate protection in a more environmentally sound product.

Coolant testing should be done at least twice annually or when major coolant loss occurs.



Diesel Coolant Trends & Changes

- Increased thermal recycling will accelerate coolant additive depletion
- Long life coolant and filters
- Increased coolant testing (minimum 2x per year)
- Increased use of organic coolants

Coolant systems are referred to as a closed loop system with the filter operating in a side loop to the main flow. This means that a small percentage of flow goes through a filter that is designed to capture large contaminants. Coolant filters intended to maintain additive levels have an internal baffle with a small hole to control the rate of additive chemical release into the system.

Periodic drain and flushing to clean a system is important because while coolant filters capture large contaminants and release additive chemicals into the system, sediment can accumulate in the coolant system. Sediment can accumulate in the system and act as an insulator keeping heat in and prevent heat dissipation.



Typical Coolant Filtration Systems

There are many commercial options available for coolant filtration. Regardless of your preference, proper maintenance is essential to engine longevity. There are two popular choices for coolant systems – traditional or organic acid types.

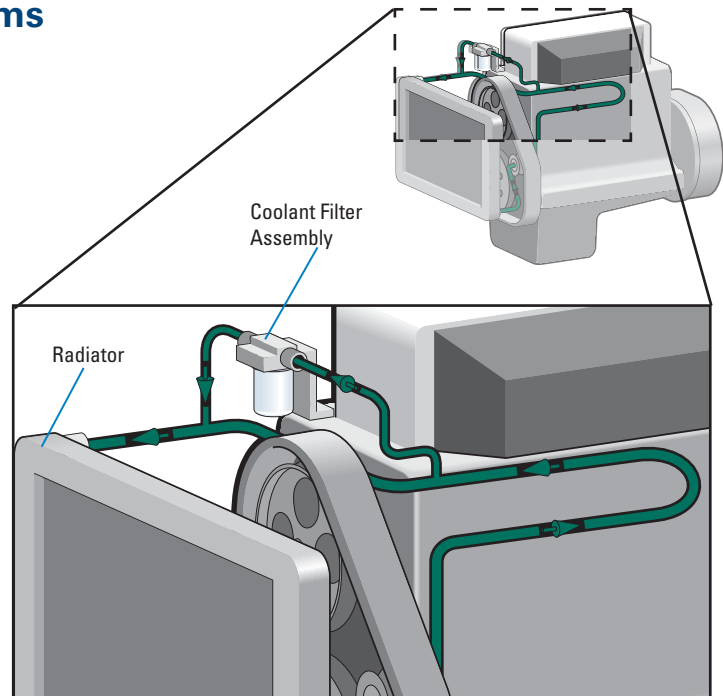

Traditional Coolant Systems

These systems are characterized by the use of ethylene glycol or propylene glycol in conjunction with a supplemental coolant additive. Typical coolant life is two years / ~300,000 miles / 480,000 kilometers). Engines using this chemical base typically recharge the chemical at every oil drain interval.

Donaldson filter options for traditional systems include:

- Pre-charged filters with
 - SCA chemicals
 - SCA+ chemicals
- Donaldson Blue™ filters with
 - slow-release additives
 - non-charged (blank) filter
user would add liquid SCA as needed

Organic Acid Coolant Systems

Organic acid technology (OAT) is a choice for those interested in long life or extended service coolant. OAT systems are not chemically compatible with the traditional SCA/SCA+ coolant systems. Typical coolant life is four years / ~600,000 miles / 965,000 kilometers. Engines using this chemical base typically recharge the coolant at ½ the life of the coolant.

Donaldson filters for OAT systems include Donaldson Blue™ (non-chemical).

Hybrid Coolant Systems

This type of coolant system is a blend of traditional and OAT coolant technologies. They may offer improved protection and extended life characteristics over OAT. The expected life is same as OAT, but with an annual recharge (vs. ½).

Donaldson filters for Hybrid systems include Donaldson Blue™ (non-chemical).



Coolant Filters

Coolant system filters are typically partial-flow (by-pass) filters, with less than 10% of the coolant flow circulating through the filter at any given time.

Donaldson coolant filter offering allows you to choose the method that suits your maintenance practices and schedules.

Donaldson coolant filters are designed to work in a wide variety of operating environments and meet the service requirements of the majority of heavy-duty diesel engines.

Use of the correct filter is important to maintain the proper balance in the system to prevent over concentration (silicate drop out) or under concentration which leads to corrosion, liner pitting or other system problems.

There are four types of Donaldson coolant additive filter types available.

- The pre-charge filter which contains enough coolant additive to initially charge the cooling system and to allow for depletion to the first service interval.
- The standard charge spin-on filters which contain adequate chemical additive to maintain cooling systems between service intervals.
- Blank filters which contain no chemical additive and can be used for the following systems, cooling systems maintained by liquid additive, systems using long life coolants which require no additive, or on overcharged systems to bring the additive level back to a normal range. Blank filters are not intended to be used with water-only systems.
- The fourth type is Donaldson Blue™ with time release spin-on series which release small amounts of additive into the system over a period of time to maintain proper additive levels.



Coolant Spin-on Design Features

The Donaldson spin-on coolant filter has three heavy-duty features: a thread-plate profile for strength, rolled threads which are cleaner, and the robust full tuck seam for extra durability. The Donaldson tapered thread profile simplifies installation and prevents cross threading. Not all filters have an inner seal between the thread plate and end plate. Donaldson's seal is constructed of molded elastomer which is designed to withstand extreme cold and heat.

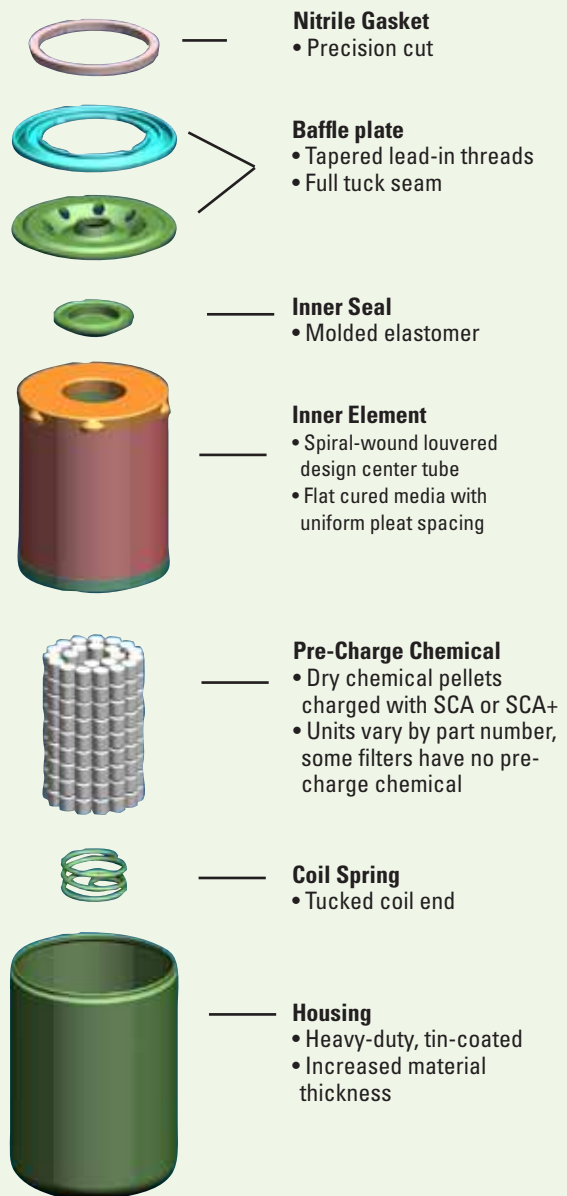



Filter Media

Coolant filter medias are available to meet the most stringent of engine system design challenges. Donaldson engineers have a history of development and application of media technology that exceeds application cleanliness and service life expectations.

Cellulose Media

Engine coolant filter media is most commonly a pleated cellulose base material. This media effectively combines an application's efficiency and capacity requirements while maintaining cost effectiveness.

Traditional based coolant systems often use this media when service intervals are maintained with non-extended oil drain intervals.

How it Works

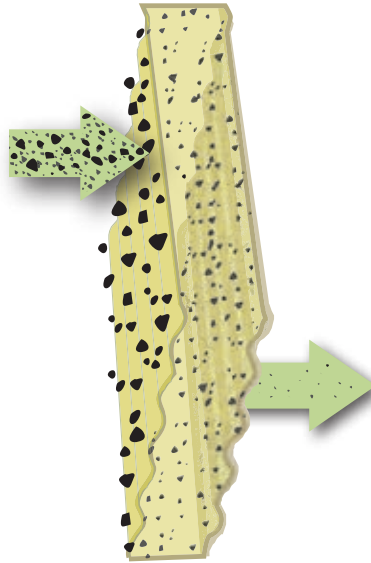

SEM 100x SEM 600x

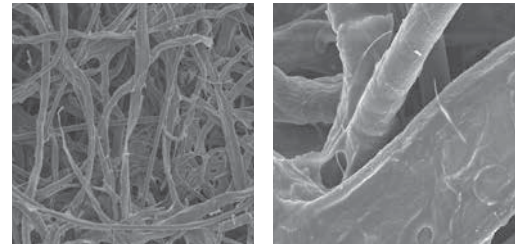

Media Image



Synteq™ Media (full synthetic)

Extended life intervals require micro-fiberglass synthetic media trademarked Synteq™. This media provides enhanced durability for extended drain intervals while maintaining or improving efficiency and capacity. Donaldson Synteq coolant media also offers lower restriction, ensuring component protection over a larger range of engine conditions.

How it Works

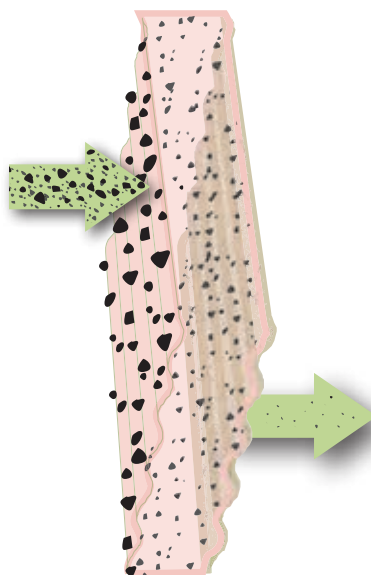

SEM 100x

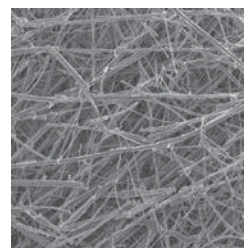

SEM 600x

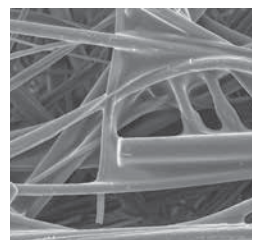

Media Image





Donaldson

BLUE™

with Additive Replenishment Technology

Donaldson Blue™ coolant filters with additive replenishment technology maintain cooling system balance through a controlled release of additives. It allows you to extend your traditional diesel engine coolant maintenance interval up to once a year or 150,000 mile / 195,000 km.

Additive Replenishment Built into the Filter

- Maintains healthy coolant condition
- Reduces maintenance costs
- Uses time-release additives to replenish coolant
- For use with supplemental coolant additive (SCA) chemistry (Ethylene Glycol or Propylene Glycol)

Direct Replacement to Standard Filter

- No system modifications or special maintenance required
- Unique design eliminates metal coil spring in bottom of housing
- No special disposal requirements
- For Caterpillar, Detroit Diesel, Volvo and Cummins engine applications

Synteq™ Filtration Media

- More effective than standard cellulose filter media
- Improved coolant flow
- Increased capacity to allow extended service interval

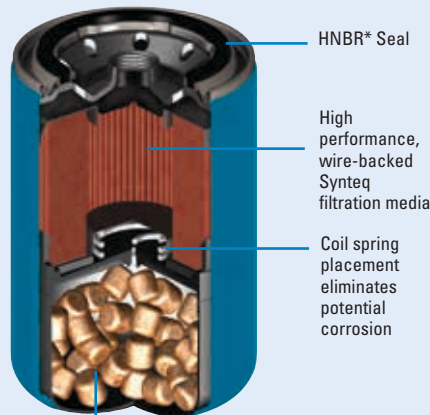

HNBR* Seal

High performance, wire-backed Synteq filtration media

Coil spring placement eliminates potential corrosion

Container releases a concentrated blend of additives through diffusion
For traditional coolants - Ethylene Glycol or Propylene Glycol

How Additive Replenishment Technology Works

Coolant enters the filter just as the standard coolant filters. Inside the filter, a controlled release of additives is introduced to maintain coolant chemistry and chemistry.

The coolant continues a normal flow to the media cartridge and passes through our Synteq filter media. Clean, replenished coolant is returned to the engine.

This additive replenishment process is optimized to effectively maintain the healthy condition of the coolant and allows you to extend your coolant maintenance interval.

* HNBR = Hydrogenated Nitrile Butadiene Rubber
HNBR is classified by ASTM as a DH-type polymer

Fits Coolant Filter	Part No.
All	DBC4088
Volvo M16 x 1.5 Thd	DBC4089

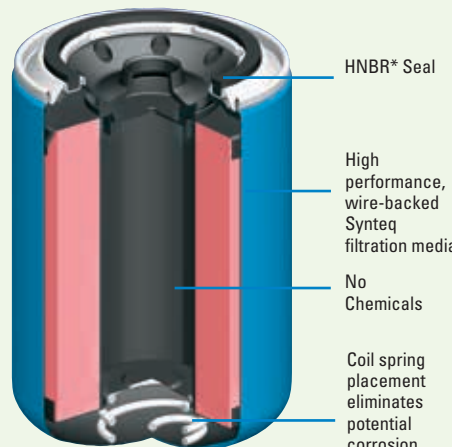

HNBR* Seal

High performance, wire-backed Synteq filtration media

No Chemicals

Coil spring placement eliminates potential corrosion

Donaldson

BLUE™

Non-chemical Donaldson Blue filters will go the distance of your coolant; for Organic Additive Technology and Extended Service Coolant Users

Fits Coolant	Part No.
All	DBC4085
Volvo M16 x 1.5 Thd	
3969696	DBC4086 - 5.35" L
20458771	DBC4081 - 4.20" L

Upgrade from a Competitive Filter to Donaldson Blue™



Donaldson Blue™	Fleetguard	Baldwin	Luber-finer	Wix	Primary Application
DBC4081	WF2129	B5145	LFW5142XL	24091	Extended Service 150K non-chemical coolant filter, Volvo
DBC4085	WF2123	B5090	LFW4685XL	24084	Extended Service 150K non-chemical coolant filter
DBC4086	WF2130	B5144	LFW5141XL	—	Extended Service 150K non-chemical coolant filter, Volvo
DBC4088	WF2131	BW5200	LFW6500	24088	Extended Service 150K coolant with chemical filter
DBC4089	WF2128	—	LFW6501	24090	Extended Service 150K coolant, Volvo



Handles Coolant Systems up to 400 Gallons / 1500 Liters

The Donaldson remote mount head is designed to fit all our spin-on filters with a 11/16" -16 threads. The bracket can be mounted remotely.

Head Part No.
P550840

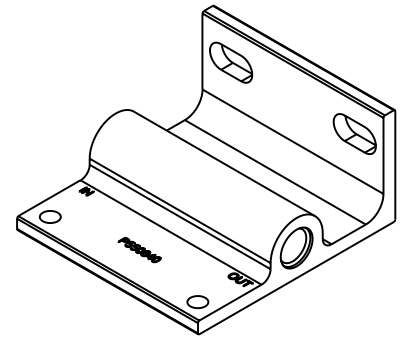
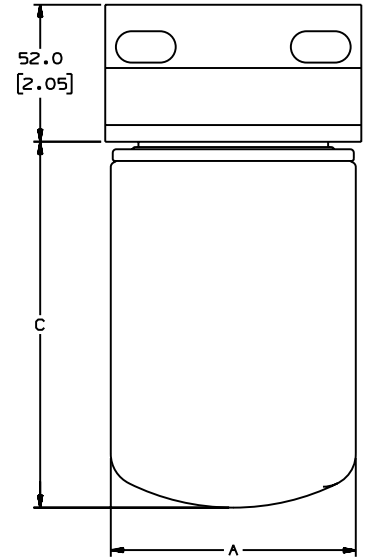
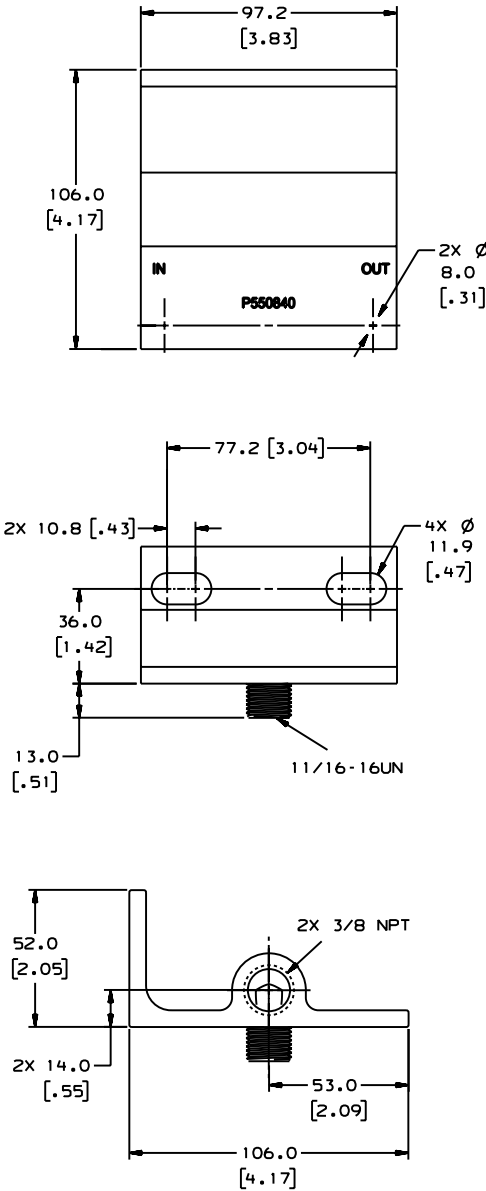

Filter Selection Chart

Outer Diameter		(C) Filter Length		Media Type	Efficiency @ Micron	Chemical Units	SCA Filter Part No.	SCA+ Filter Part No.	
in	mm	in	mm						
3.66	93	4.21	107	Cellulose	99% @ 50	2 Units	N/A	P552070	
				Cellulose	99% @ 50	4 Units	P554071	P552071	
				Cellulose	99% @ 50	6 Units	P554072	P552072	
		5.35	135	Synteq	99% @ 14	Extended Service No Chemical	DBC4085		
						Extended Service, Time Release	DBC4088	N/A	
				Cellulose	99% @ 50	8 Units	P554073	P552073	
				Cellulose	99% @ 50	12 Units	P554074	P552074	
				Cellulose	99% @ 50	15 Units	P554075	P552075	
				Cellulose	99% @ 50	Standard Service No Chemical	P554685		
				Cellulose	99% @ 50	23 Units	N/A	P552076	



Spin-On Coolant Filters

Thread	OD		Length		Part No.	Part Description	Efficiency @ Micron	Primary Application	GSKT O.D.		GSKT I.D.	
	IN	MM	IN	MM					IN	MM	IN	MM
Non-Chemical Filters												
11/16 - 16	3.66	93	5.35	136	P554685	Spin-on non-chemical	50% @ 20	CUMMINS	2.81	71	2.42	61
3/4-20	3.67	93	5.32	135	P551309	Spin-on non-chemical	50% @ 25	MACK	2.81	71	2.42	61
M36 x 2	3.69	94	5.76	146	P550867	Spin-on non-chemical	99% @ 50	With Synteq	3.66	93	3.17	81
SCA Filters												
1-16	4.28	109	5.78	147	P554422	Spin-on 11 Units - SCA		MACK 25MF422	3.89	99	3.55	90
11/16 - 16	3.66	93	4.21	107	P554071	Spin-on 4 Units - SCA	50% @ 25	CUMMINS 3315116	2.81	71	2.42	61
	3.66	93	4.21	107	P554072	Spin-on 6 Units - SCA	50% @ 25	CUMMINS 3318201	2.81	71	2.42	61
	3.66	93	5.35	136	P554073	Spin-on 8 Units - SCA	50% @ 25	CUMMINS 3315115	2.81	71	2.42	61
	3.66	93	5.35	136	P554074	Spin-on 12 Units - SCA	50% @ 25	CUMMINS 3316053	2.81	71	2.42	61
	3.66	93	5.35	136	P554075	Spin-on 15 Units - SCA	50% @ 25	CUMMINS 3318318	2.81	71	2.42	61
	3.66	93	7.89	200	P552055	Spin-on 23 Units - SCA	50% @ 20	CUMMINS 3305371	2.81	71	2.42	61
	3.69	94	5.32	135	P552106	Spin-on 4 Units - SCA	50% @ 25	NAVISTAR	2.83	72	2.46	62
	3.69	94	5.44	138	P552088	Time-release Spin-on, 43 Units	99% @ 25	NALCO NF2008, PENRAY NR2088, FLEET-GUARD WF2131, 10-20 gal capacity	2.85	72	2.42	61
3/4-20	3.66	93	5.35	136	P554860	Spin-on 8 Units - SCA	99% @ 50	MACK 25-MF-314A	2.81	71	2.42	61
M16 x 1.5	3.66	93	5.35	136	P552096	Spin-on 5 Units - SCA	99% @ 50	VOLVO 1661964 ,1699830	2.81	71	2.42	61
	3.66	93	5.35	136	P554019	Spin-on 8 Units - SCA	99% @ 50	VOLVO 3945411	2.81	71	2.42	61
SCA+ Filters												
11/16 - 16	3.66	93	7.87	200	P552076	Spin-on 23 Units - SCA+	50% @ 20	CUMMINS 3318319	2.83	72	2.44	62
	3.69	94	4.15	105	P552071	Spin-on 4 Units - SCA+	50% @ 25	CUMMINS 3315116	2.83	72	2.46	62
	3.7	94	4.07	103	P552070	Spin-on 2 Units - SCA+	50% @ 25	CUMMINS 3318157	2.85	72	2.45	62
	3.7	94	4.07	103	P552072	Spin-on 6 Units - SCA+	50% @ 25	CUMMINS 3318201	2.85	72	2.45	62
	3.7	94	5.32	135	P552073	Spin-on 8 Units - SCA+	50% @ 25	CUMMINS 3315115	2.85	72	2.45	62
	3.7	94	5.32	135	P552074	Spin-on 12 Units - SCA+	50% @ 25	CUMMINS 3316053	2.85	72	2.45	62
	3.7	94	5.32	135	P552075	Spin-on 15 Units - SCA+	50% @ 25	CUMMINS 3318318	2.85	72	2.45	62
M36 x 2	3.69	94	5.76	146	P550866	Spin-on 8 Units - SCA+	99% @ 50	Cummins Extended Life Coolant	3.66	93	3.17	81
Donaldson Blue™ Extended Service Filters												
11/16 - 16	3.66	93	5.33	135	DBC4085	Spin-on non-chemical	99% @ 14	EXTENDED SERVICE FILTER	2.83	72	2.44	62
M16 x 1.5	3.66	93	4.20	107	DBC4081	Spin-on non-chemical	99% @ 50	EXTENDED SERVICE FILTER	2.83	72	2.44	62
M16 x 1.5-6H	3.66	93	5.35	136	DBC4086	Spin-on non-chemical	99% @ 14	EXTENDED SERVICE FILTER VOLVO	2.73	72	2.44	62
11/16 - 16	3.67	93	5.35	136	DBC4088	Spin-on, additive replenishment technology	99% @ 14	EXTENDED SERVICE COOLANT	2.83	72	2.44	62
M16 x 1.5-6H	3.66	93	5.35	136	DBC4089	Spin-on, additive replenishment technology	99% @ 14	EXTENDED SERVICE COOLANT, VOLVO	2.83	72	2.44	62

Coolant Hose - 3 & 4 Ply

Designed to withstand extremes in operating temperatures ranging from -65°F to 350°F (-54°C to 177°C).

3-ply hose 3 ft./0.91m lengths

3-ply hose is reinforced with three layers of polyester fabric and coated with a unique silicone elastomer.



Size (inner dia.)		Part No.	Nominal O.D.		Recommended Clamp	
in	mm		in	mm	Lined	Constant Torque
0.63	16	P171371	0.95	24	P532921	N/A
0.75	19	P171372	1.08	27	P532923	N/A
0.88	22	P171373	1.20	30	P532923	N/A
1.00	25	P171374	1.33	34	P532923	N/A
1.13	29	P171375	1.45	37	P532924	N/A
1.25	32	P171376	1.90	48	P532924	N/A
1.38	35	P171377	1.70	43	P115200	N/A
1.50	38	P171378	1.83	46	P115200	N/A
1.63	41	P171379	1.95	50	P115200	N/A
1.75	44	P171380	2.08	53	P115200	N/A
2.00	51	P171381	2.33	59	P115200	P532925
2.25	57	P171382	2.58	66	P115201	P532925
2.38	60	P171383	2.70	69	P115201	P532925
2.50	64	P171384	2.83	72	P115201	P532925
2.63	67	P171385	2.95	75	P143422	P532925
2.75	70	P171386	3.08	78	P143422	P532926
3.00	76	P171387	3.33	85	P143422	P532926
3.50	89	P171388	4.83	123	P115202	P532927
4.00	102	P171389	4.33	110	P115203	P532928

4-ply hose 3 ft./0.91m lengths

4-ply hose is reinforced with an added layer of polyester fabric and provides even greater resistance to abrasion and rubbing.



Size (inner dia.)		Part No.	Nominal O.D.		Recommended Clamp	
in	mm		in	mm	Lined	Constant Torque
1.00	25	P171390	1.40	36	P532924	N/A
1.50	38	P171391	1.90	48	P115200	N/A
2.00	51	P171392	2.40	61	P115201	P532925
2.50	64	P171394	2.89	73	P115201	P532925
2.75	70	P171395	3.15	80	P143422	P532926

SCA/SCA+ Chemical Differences

What are the SCA chemicals and how do they do their job?

Nitrite is the key chemical component in SCA cooling system treatment. Nitrite provides protection against cavitation, erosion, and it inhibits corrosion. Nitrate also provides corrosion protection to aluminum and solder.

Borate functions as an alkaline buffer to prevent acidity and controls pH.

MBT (Mercaptabenzothiazole) provides a plating effect on all copper and copper alloys, protecting them from direct contact with coolant and oxygen, and subsequent corrosion.

Silicate reduces corrosion of ferrous metals and is an effective aluminum corrosion inhibitor.

SCA may be substituted for DCA2 and BTE

SCA+ may be substituted for DCA4 and BTA Plus

While the chemical composition of SCA+ Cooling System Treatment features some of the same chemicals, there are differences.

Molybdate and Nitrite are combined to provide cavitation erosion protection and inhibit corrosion.

Silicate reduces corrosion of ferrous metals and is an effective aluminum corrosion inhibitor. Phosphate functions as an alkaline buffer to prevent acidity and controls pH.

Donaldson SCAs combat a whole series of coolant system problems including, rust, scale from minerals, acidity from antifreeze, the intrusion of air fuel and oil to coolant, pitting of engine parts from cavitation, foaming from coolant aeration and silicate drop-out from over-concentration.



Coolant Additives

Supplemental Coolant Additive (SCA and SCA+) is available in many sizes, from a pint to a 55-gallon drum.



Cooling System Treatment

Size	SCA	SCA+
1 Pt./ 0.47 L.	X006136	X007099
1 Qt./ .95 L.	X007036	
2 Qt./ 1.89 L.	X007037	X007100
1 Gal./ 3.79 L.	X007038	
5 Gal./ 18.93 L.	X006137	X007101
Drum: 55 Gal./ 208.2 L.	X006138	X007102

Re-charge Cooling System after Flush

Cooling System Capacity Add this amount of SCA or SCA+

5-7 gallons	18.9-26.5 liters	2 pints	0.9 liters
8-11 gallons	30.3-41.6 liters	3 pints	1.4 liters
11-15 gallons	41.6-56.8 liters	4 pints	1.9 liters
16-20 gallons	60.6-75.7 liters	5 pints	2.4 liters
21-30 gallons	79.5-113.6 liters	1 gal	3.8 liters
31-50 gallons	117.3 to 189.3 liters	1.5 gal	5.7 liters
51-75 gallons	193.0-283.9 liters	2.25 gal	8.5 liters
76-100 gallons	287.7-378.5 liters	3 gal	11.4 liters
101-150 gallons	382.3-567.8 liters	4.5 gal	17.0 liters
151-200 gallons	571.5-757.0 liters	6 gal	22.7 liters
201-250 gallons	760.8-946.3 liters	7.5 gal	28.4 liters
251-300 gallons	950.0-1135.5 liters	9 gal	34.1 liters
301-350 gallons	1139.3-1324.8 liters	10.5gal	39.7 liters
351-400 gallons	1328.5-1514.0 liters	12gal	45.4 liters



Thermo-Tech Heavy-Duty Coolant

Available in Australia Only

Note:

Product featured on this page is available in Australia only.
Contact Donaldson Australasia Customer Service on 1800 345 837 to find a distributor near you.
Further information can be found on www.donaldsontoolbox.com.au

Donaldson's Thermo-Tech range covers all of your fleet coolant needs, including conventional heavy-duty technologies, environmentally friendly organic product, and our superior long life propylene glycol hybrid offering.

Thermo-Tech PG is the premium coolant in our range and (if required) is fully compatible with all other Propylene Glycol (PG), Ethylene Glycol (EG) or Organic Acid Technology (OAT) coolants. It is designed for use with all types of diesel, petrol and LPG engines and offers the following features:

- Premixed and ready to use
- Extended life
- Lasts up to 6 years, 12,000 hours or 1,000,000 kilometres in heavy-duty applications
- Lasts up to 5 years or 250,000 kilometres in 4WDs and passenger vehicles
- Superior corrosion protection



Donaldson Thermo-Tech PG is available in:

	PREMIX	CONCENTRATE
5 Litres	P903106	-
20 Litres	P903107	-
205 Litres	P903108	-
1000 Litres	P903109	-

Contains 495g/L propylene glycol

Thermo-Tech EG is an Ethylene Glycol based coolant designed for use with all types of diesel, petrol and LPG engines. Thermo-Tech EG is a conventional coolant based on a proprietary formulation of corrosion inhibitors and offers the following features:

- No need for supplemental coolant additives (SCA's) upon initial fill
- Lasts up to 2 years, 3,000 hours or 320,000 kilometres in heavy-duty applications
- Lasts up to 3 years or 100,000 kilometres in 4WDs and passenger vehicles
- Compatible with other conventional coolants (if being used as a top-up)
- Specially formulated to protect heavy-duty wet sleeve liners



Donaldson Thermo-Tech EG is available in:

	PREMIX	CONCENTRATE
5 Litres	P903100	-
20 Litres	P903101	P903104
205 Litres	P903102	P903105
1000 Litres	P903103	-

Premix contains 545g/L ethylene glycol

Thermo-Tech OAT (Organic Acid Technology) is a water based coolant designed for use with all types of diesel, petrol and LPG engines. Thermo-Tech OAT is a glycol free coolant based on a proprietary formulation of corrosion inhibitors & offers the following features:

- No need for supplemental coolant additives (SCAs) upon initial fill
- Lasts up to 4 years, 12,000 hours or 1,000,000 kilometres in heavy-duty applications
- Lasts up to 3 years or 100,000 kilometres in 4WDs and passenger vehicles
- Specially formulated to protect heavy-duty wet sleeve liners
- Organic formula is free from glycol, amine, borate, phosphate, nitrates, nitrites & silicate
- Compatible with other organic coolants (if being used as a top-up)



Donaldson Thermo-Tech OAT is available in:

	PREMIX	CONCENTRATE
5 Litres	P903110	-
20 Litres	P903111	P903114
205 Litres	P903112	P903115
1000 Litres	P903113	-

Thermo-Tech Radiator Flush is an engine cooling system cleaner designed for use with all types of diesel, petrol and LPG engines. Thermo-Tech Radiator Flush is a non-acidic, alkaline-based cleaner offering the following features:

- Removal of rust and scale
- Compatible with all coolant types
- Suitable for heavy-duty on and off-road applications



Thermo-Tech Radiator Flush is available in:

	RADIATOR FLUSH
5 Litres	P903116
20 Litres	P903117
205 Litres	-
1000 Litres	-

Contains 140g/L alkaline salts



Diesel Engine Coolant Maintenance Requires

- Low silicate antifreeze
- Good quality water
- Protective Coolant Additive
- Routine Coolant Concentration Testing

Test Strip Kit

Donaldson test kits offer a quick, one-minute test that helps you maintain that cooling system chemical balance. Donaldson recommends testing your coolant twice a year.

N. America (shown) Part No. **X007684**

(12 test strips per package)

Australia Part No. P901874 (4 strip),

X007103 (50 strips), P901873 (25 -4 strip box)



Cooling system service guidelines at service intervals or at flush and re-charge time.

Servicing up to 20 Gallons / 75.7 L

Install a new filter corresponding SCA/SCA+ units

Service Interval			0-5 gals	6-10 gals	11-15 gals	16-20 gals
@ Miles	@ KM	@ Hours	0-19 L	22.7-37.8L	41.6-46.7 L	60.6-75.7 L
5,000	8045	125 hrs	n/a	2 units	2 units	2 units
10,000	16,090	250 hrs	2 units	2 units	4 units	4 units
15,000	24,135	375 hrs	2 units	4 units	4 units	6 units
20,000	32,180	500 hrs	2 units	4 units	6 units	8 units
25,000	40225	625 hrs	2 units	4 units	8 units	12 units

*SCA or SCA+

Greater than 20 gallons / 75.7 liters

SCA/SCA+ additive replenishment recommendations

Cooling System Capacity		at 250 Hours		at 500 Hours	
21-30 gallons	79.5-113.6 liters	2 pints	0.9 liters	3 pints	1.4 liters
31-50 gallons	117.3-189.3 liters	3 pints	1.4 liters	5 pints	2.4 liters
51-75 gallons	193.0-283.9 liters	4 pints	1.9 liters	8 pints	3.8 liters
76-100 gallons	287.7-378.5 liters	5 pints	2.4 liters	10 pints	4.7 liters
101-150 gallons	382.3-567.8 liters	8 pints	3.8 liters	15 pints	7.1 liters
151-200 gallons	571.5-757.0 liters	10 pints	4.7 liters	20 pints	9.5 liters
201-250 gallons	760.8-946.3 liters	13 pints	6.2 liters	25 pints	11.8 liters
251-300 gallons	950.0-1135.5 liters	15 pints	7.1 liters	30 pints	14.2 liters
301-350 gallons	1189.3-1324.8 liters	18 pints	8.5 liters	35 pints	16.6 liters
351-400 gallons	1328.5-1514.0 liters	20 pints	9.5 liters	40 pints	18.9 liters

Actions Required After Testing



If your additive is

Below 1.2 units per 1 gallon / 3.8L

Replace the coolant filter and add 1 pint (.47L) of additive liquid per each 4 gallons /15.1L of coolant

Between 1.2 - 3 units per 1 gallon / 3.8L



Continue to replace the coolant filter at each oil drain interval.

Greater than 3 units per 1 gallon / 3.8L

Replace the coolant filter with a non-charged filter until the additive concentration falls below 3 units per 1 gallon/3.8 subsequent oil drain interval.



Proper Steps for Spin-on Coolant Filter Replacements

When a cooling system is serviced, coolant filters are replaced dry. They are not pre-filled with any fluids. After coolant filter installation, the coolant fluid mixture is poured into the radiator overflow reservoir.



1 Remove radiator cap; caution if hot or under pressure



2 Unscrew and remove old filter and gasket



3 Wipe filter head with clean cloth



4 Apply thin film of clean motor oil to gasket



5 Align threads; spin filter on until gasket contact



6 Follow icons on filter to tighten



7 Pour coolant mix into overflow



8 Start engine and check for leaks



9 Test coolant according to type

SERVICE TRAINING VIDEOS





Cooling System Problems & Failures

There are many cooling system problems and failures. Most of these problems have occurred due to incorrect information and maintenance practices. The following will address these problem areas by correcting the erroneous information and listing the proper maintenance practices.

The chart shown below is a listing of the six most common problems seen in today's cooling system. Along with each problem is a description of how it occurs, how it affects your engine and, most importantly, the cure.

Problem	How it Happens	What it Can Do	The Cure
Rust	Oxidation within the cooling system	Clog the system. Cause accelerated wear	The inhibitors in a quality Supplemental Coolant Additive (SCA) prevent oxidation.
Acidity	One of two items: Ethylene glycol antifreeze reacts with oxygen in the air and forms acids; a loose head gasket or other leakage can allow sulphuric acids formed by the burning of fuel to leak into the cooling system.	Corrode iron, steel and aluminum.	The SCA keeps salt minerals in suspension so they cannot deposit on the engine metal surfaces or clog passages.
Pitted Cylinder Liners	Constant vibration of the cylinder liner causes a momentary vacuum to form on its surface. Coolant boils into the vacuum and vapor bubbles implode on the surfaces of the liner, digging into unprotected liners.	Cause pits which can extend over time, through the thickness of the liner and allow coolant to enter the combustion chamber or crankcase.	The SCA coats the liner with a thin film to protect it from erosion without impacting heat transfer.
Foam	Foam – the aeration of coolant – occurs from air leakage into the system.	Adds to the cavitation erosion problem, particularly in areas of water pump impellers	Today's SCAs have an anti-foam agent to prevent formation of air bubbles. This foam prevention agent is effective at all temperatures, even during start-up.
Pitted Water Pump Impellers	Flow rates and turbulence are high at the impeller blade. This causes cavitation. In addition there is a possibility that abrasive particles are present in the system.	Cause loss of pump efficiency and total pump failure	The supplemental additives protect the impeller from cavitation erosion and the filter holds particulate matter to reduce abrasive wear on the cooling system components

Re-printed with permission of the Filters Manufacturer's Council : Technical Service Bulletin 88-1

Donaldson provides this technical reference as a short course in “Engine Liquid Filtration 101” – for those who want to gain a better understanding of fluid filtration for engines.

In engine applications all over the world, we too often see engine systems that don’t include proper fluid filtration (especially fuel), or include it as an afterthought. Good filtration needs to be an integral part of the circuit to ensure the long life and proper operation of the pumps, turbos, injectors and bearings. Today diesel engines are very sophisticated with many precision systems working together. These systems require optimum filtration to ensure their performance.

This guide is offered to aid in choosing the filter that will help you achieve the ideal cleanliness levels and longest life for your critical components.

Material in this section is in the public domain, not confidential, and may be copied for educational purposes at any time. Information was collected from many sources, both public and private, including Donaldson Company, Inc. Engineering Departments, Society of Automotive Engineering (SAE), ISO, and various industry authorities.

Engine Components Need Protection	124
How Contamination Damages Precision Parts.....	124
Where Contamination Comes From	125
Basic Filtration Principles.....	126
Liquid Filtration Pressure Drop.....	128
Combining the ISO Rating and Filter Performance Ratings.....	130
ISO Rating System.....	130
Filter Efficiency Ratings.....	131
Fuel Filtration - Biodiesel Fuels.....	132
Filtration for Alternative Fuels: CNG, LPG & LNG Systems	135
Oil Analysis.....	136
Frequently Asked Questions (index of questions)	137
Fuel	138
Lube.....	139
Coolant	140
Fuel Filtration Application Design Worksheet.....	143
Lube Filtration Application Design Worksheet	145

Symbols Used

β	Beta Ratio
cSt	Centistokes
DP	Pressure Drop or Differential Pressure
ISO	International Standards Organization
μm	Micron or micrometer
ppm	Parts per million
SSU	Saybolt Seconds Universal
SUS	

Engine Components Need Protection

Engine liquid circuits (lube, fuel and coolant) are designed in all shapes and sizes, both simple and complex in design, and they all need protection from damaging contamination. Abrasive particles enter the system and, if unfiltered; damage sensitive components like pumps, bearings and injectors. It is the job of the filter to remove these particles from the fluid flow to help prevent premature component wear and system failure. As the sophistication of engine systems increases, the need for reliable filtration protection becomes ever more critical.

How Contamination Damages Precision Parts

This cutaway view of a simple oil valve illustrates how particles damage components. In normal operation, the spool slides back and forth in the valve body, diverting oil to one side of the valve or the other. This type of valve is typical in engine oil control circuits. If a particle lodges between the spool and valve body, it will erode small flakes from the metal surfaces. As these flakes are moved back and forth by the action of the spool, they can roll into a burr that jams the spool and disables the valve.

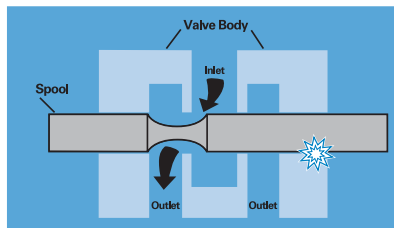

In the pictures below, we see examples of how contamination can impact fuel injectors. Fuel injector nozzles are small passages that deliver an evenly distributed fine mist of fuel to the combustion chamber. These fine passages can become plugged with contamination.

In the pictures below, we see examples of how contamination can impact fuel injectors. Fuel injector nozzles are small passages that deliver an evenly distributed fine mist of fuel to the combustion chamber. These fine passages can become plugged with contamination.



Close up of new (left) and worn (right) fuel injector nozzles.

Another wear area can be the fuel injector needle seat. The needle mates to a seat which is the sealing surface to control the flow of fuel to the combustion chamber. If a particle becomes trapped between the needle and seat it can hold the needle open. In addition, this particle can wear the surface – causing it to become irregular and disable the sealing function of the needle. This can impact the fuel delivery performance of the injector.

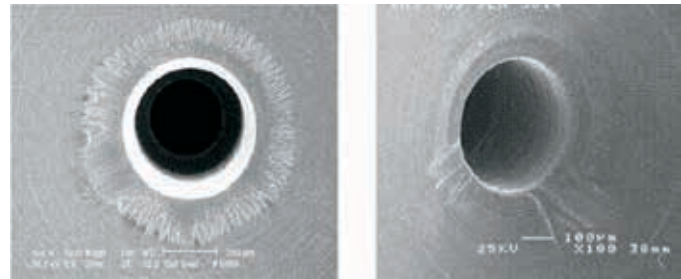

Close-up of worn fuel injector needle seat.

Types of Contaminant

Many different types of contamination may be present in engine fluids, causing various problems. Some are:

- Particulate (dust, dirt, sand, rust, fibers, elastomers, paint chips)
- Wear metals, silicon, and excessive additives (aluminum, chromium copper, iron, lead, tin, silicon, sodium, zinc, barium, phosphorous)
- Water
- Sealant (Teflon®* tape, pastes)
- Sludge, oxidation, and other corrosion products
- Acids and other chemicals
- Biological, microbes

Where Contamination Comes From

New Fluids

Adding new fluid can be a source of contamination. Even though it's fresh from the drum, new engine oil isn't clean. (It may look clean, but, remember, the human eye can only see a particle the size of about 40 μm .) Also, diesel fuel cleanliness varies from pump to pump. Typical fuel cleanliness levels coming out of the pump are ISO rated at 22/21/18. (ISO cleanliness code of 22/21/18 translates to a particle count of 20,000 to 40,000 per milliliter for particles of 4 μm and greater; 10,000 to 20,000 per milliliter for particles of 6 μm and greater; and 1300 to 2500 per milliliter for particles of 14 μm and greater), and water content is typically 200 to 300 ppm. Never assume your fluids are clean until it has been filtered.

Built-In

Built-in contamination, also called primary contamination, is caused during the manufacture, assembly and testing of the engine and its components. Metal filings, small burrs, dirt or sand and other contaminants are routinely found in initial clean up filtration of newly manufactured engines.

Ingressed

Ingressed or external contamination comes from the environment surrounding the engine or vehicle. Dirt can enter the engine liquid supply through crank case breathers or fuel tank breathers and vents and the air intake system. Ingressed moisture, particularly, can cause longer term problems. As a hot system cools at night, cool moisture-laden air can be drawn into the engine or fuel tank; as the air condenses, water is released into the engine or fuel tank. Water in excess of 0.5% by volume in a hydrocarbon-based fluid accelerates the formation of acids, sludge and oxidation that can attack internal components, cause rust, and adversely affect lubrication properties. The severity of ingression and type of contaminant are dictated by the applications and environment.

Induced

Maintenance procedures can introduce contamination into the engine. Opening the engine allows airborne particles to enter.

Removing air filters, opening oil caps, fuel tank caps and removal of oil and fuel filters are all possible sources for introducing contamination to an engine. Keep your system closed as much as possible and take care to be sure everything that goes into the engine is as clean as possible. One common example is very often funnels are used fill the engine with oil. The oily funnel will collect dirt between uses. The funnel should be properly cleaned before using it to fill the engine with oil.

In-Operation

The major sources of contamination in the engine are the combustion by-products (soot) and oxidation of the fluids in the engine due to the thermal stressing. Wear-generated contaminants are a hazard during engine operation.

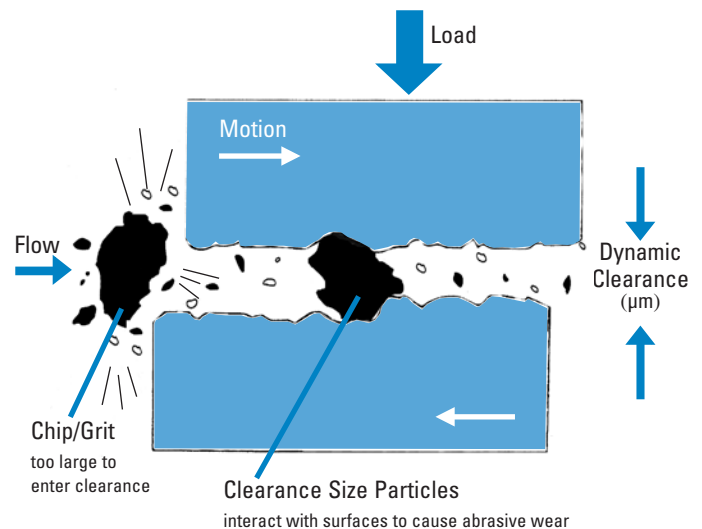

The circuit actually generates additional particles as the fluid comes into contact with the precision machined surfaces of cylinder walls and pistons, injector needles and pistons and crankshaft bearings. Contaminant levels can keep doubling with every new particle generated. The result can be catastrophic if these contaminants are not properly filtered out of the system.

Rubber & Elastomers

Due to temperature, time, and high-velocity fluid streams, rubber compounds and elastomers degrade—thus releasing particulates into the fluid.

Biodiesel

Biodiesel can support biological growth and generate organic contamination and microbes.

Basic Filtration Principles

Filter Media

Media is a term used to describe any material used to filter particles out of a fluid flow stream. There are four basic types used to remove contamination in engine applications:

Synthetic Media

Synthetic fibers are man-made, smooth and rounded of provide the least resistance to flow. Their consistent shape allows us to control the fiber size

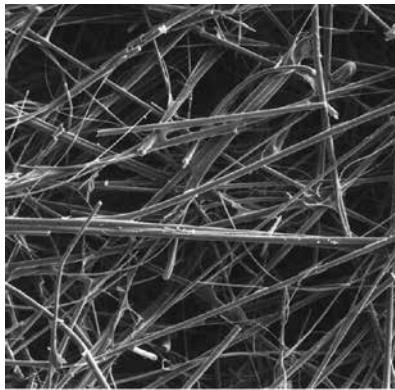

Donaldson Synteq™ synthetic filter media (left) is magnified hundreds of times under the scanning electron microscope. The smooth rounded fibers provide low resistance to fluid flow.

and distribution pattern throughout the media mat to create the smoothest, least inhibited fluid flow. Consistency of fiber shape allows the maximum amount of contaminant-catching surface area and specific pore size control.

The result is media with predictable filtration efficiencies at removing specified

contaminants (e.g., 4 µm) and maximum dirt holding capacity.

The low resistance of synthetic media to fluid flow makes it ideal for synthetic fluids, water glycols, water/oil emulsions, and petroleum based fluids.

Cellulose Media

Cellulose fibers are actually wood chips, microscopic in size and held together by resin. As you see in the photo below, the fibers are irregular in both shape and size.

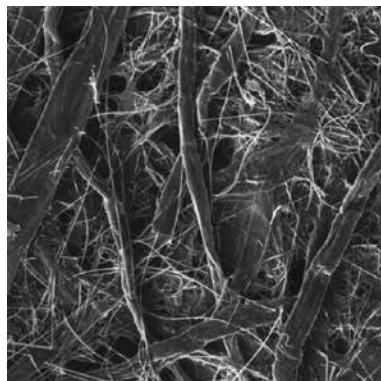

Cellulose filter media photo from scanning electron microscope magnified hundreds of times.

Cellulose often has lower efficiency ratings, which means there are smaller pores in the media.

Smaller media pores cause more flow resistance, in turn causing higher pressure drop.

While cellulose provides effective filtration for a wide variety of petroleum-base fluids, in certain applications it results in poor filtration performance as compared to synthetic media.

Composite Media

Composite media are where synthetic media and cellulose media are put together to provide some of the benefits of both for certain applications. In some applications where flow rates are lower and cellulose media properties are desired, but more capacity is required a composite media is used.



Donaldson's third generation of Synteq fuel filter water separator media uses both cellulose and meltblown synthetic layer to achieve the highest levels of fuel filtration performance

These are typically fuel applications. You get the high capacity of synthetic media and the water separation characteristics of treated cellulose, to create a cost effective and long life media.

Wire-Mesh Media

Wire-mesh media consists of stainless steel, epoxy-coated wire mesh available in 3 sizes:

- 100 mesh yields 150 µm filtration
- 200 mesh yields 74 µm filtration
- 325 mesh yields 44 µm filtration

Typically wire-mesh filters will be applied to catch very large, harsh particulate that would rip up a normal filter. You may also find this media useful as a coarse filter in viscous fluid applications.

How Filter Media Functions In a Filtration System

The job of the media is to capture particles and allow the fluid to flow through. For fluid to pass through, the media must have holes or channels to direct the fluid flow and allow it to pass. That's why filter media is a porous mat of fibers that alters the fluid flow stream by causing fluid to twist, turn and accelerate during passage.

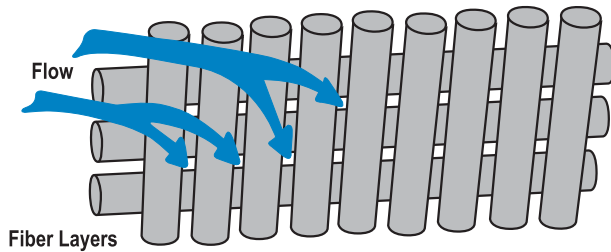

The fluid changes direction as it comes into contact with the media fibers, as illustrated above. As the fluid flows through the media, it changes direction continuously as it works its way through the maze of media fibers. As it works its way through the depths of the layers of fibers, the fluid becomes cleaner and cleaner. Generally, the thicker the media, the greater the dirt-holding capacity it has.

Looking at a cross section view of the fibers, we can see how the flow stream is accelerated as it flows into the spaces between the fibers.

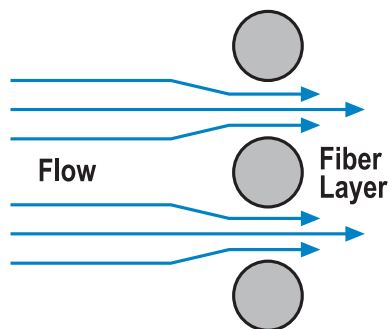

How Filter Media Collects Particles

Basic ways filter media captures particles

The first, called inertia, works on large, heavy particles suspended in the flow stream. These particles are heavier than the fluid surrounding them. As the fluid changes direction to enter the fiber space, the particle continues in a straight line and collides with the media fibers where it is trapped and held.

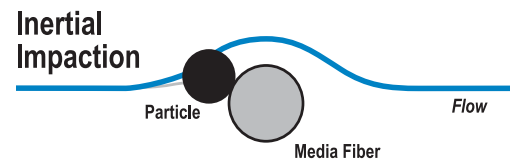

The second way media can capture particles is by diffusion. Diffusion works on the smallest particles. Small particles are not held in place by the viscous fluid and diffuse within the flow stream. As the particles traverse the flow stream, they collide with the fiber and are collected.

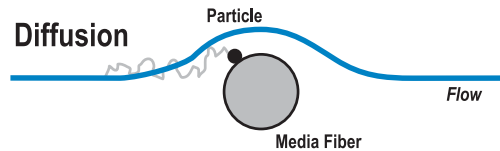

The third method of particle entrapment is called interception. Direct interception works on particles in the mid-range size that are not quite large enough to have inertia and not small enough to diffuse within the flow stream. These mid-sized particles follow the flow stream as it bends through the fiber spaces. Particles are intercepted or captured when they touch a fiber.

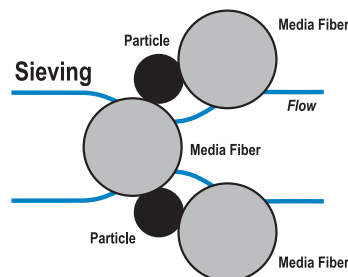
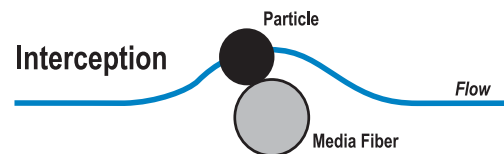

The fourth method of capture is called sieving and is the most common mechanism in liquid filtration. As shown at right, this is when the particle is too large to fit between the fiber spaces.

Liquid Filtration Pressure Drop

The difference between the inlet pressure and the outlet pressure is called pressure drop or differential pressure. It's symbolized by ΔP . ΔP is an irrecoverable loss of total pressure caused by the filter, and is mostly due to frictional drag on the fibers in the media.

ΔP may increase as the particulate rating or efficiency of the filter gets better. ΔP also increases as the filter is being loaded with contaminant.

Major Factors Contribute to Pressure Drop

1. Filter Media

Media is the main factor influencing pressure drop; indeed, it causes pressure drop. That's why having a low-friction, high-flowing media is so important. The natural cellulose or paper fibers (shown at left) typically used in filtration are large, rough, and as irregular as nature made them.

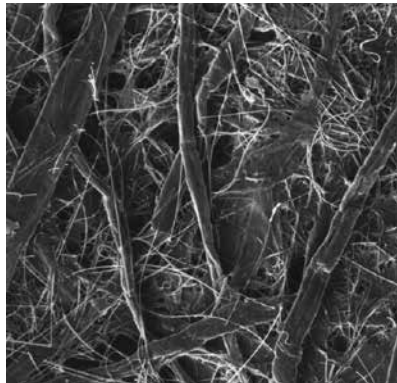

Cellulose filter media photo from scanning electron microscope magnified hundreds of times.

Donaldson developed a synthetic media with smooth, rounded fibers, consistently shaped so that we can control the fiber size and distribution pattern throughout the media mat, and allow the smoothest, least inhibited fluid flow.

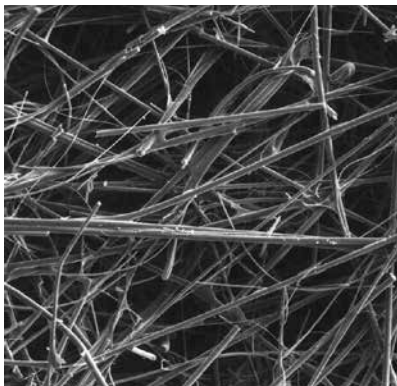

Donaldson Synteq™ synthetic filter media (left) is magnified hundreds of times under the scanning electron microscope. The smooth rounded fibers provide low resistance to fluid flow.

Our synthetic media is named Synteq. Synteq fibers offer the least amount of resistance to fluid passing through the media. Consistency of fiber shape allows the maximum amount of contaminant catching surface area and specific pore size control.

The result is media with predictable filtration efficiencies at removing specified contaminants (i.g., 4 μm) and maximum dirt holding capacity. Natural cellulose fibers are larger than synthetic fibers and jagged in shape, so controlling size of the pores in the media mat is difficult and there is less open volume. In most applications this results in higher ΔP as compared to synthetic filters. Higher beta ratings mean there are smaller pores in the media; smaller media pores cause more flow resistance, in turn causing higher pressure drop.

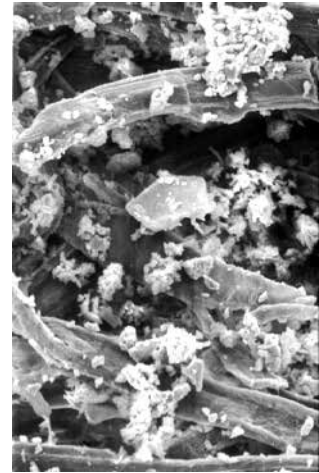

2. Dirt, Contaminant

As dirt gets caught in the media, it eventually begins to build up and fill the pore openings. As the pore openings shrink, the differential pressure (pressure drop) increases. This is called restriction. This photo from our scanning electron microscope shows actual dirt particles building up in the media pores.

Typically there is a restriction limit for the system the filter has been applied to. The amount of restriction filter can have before the system performance becomes affected is called the filter terminal pressure drop. This will usually be the point at which the filter capacity will be stated.

3. Flow

Higher flows create higher pressure drop. With fast moving fluid, there will be more friction causing higher pressure drop across the media.

4. Fluid Viscosity

Measured in centistokes (cSt) or Saybolt Seconds Universal (SSU or SUS), fluid viscosity is the resistance of a fluid to flow. As fluid viscosity increases, the cSt rating increases. Higher fluid viscosities also mean higher pressure drop because the thicker oil has a tougher time passing through the layer of media fibers. Cold start fluid is a good example of highly viscous fluid. See chart below.

Filter media, amount of contamination, flow rate, and fluid viscosity are all factors in the importance of sizing the filter for the system requirements. Filters that are too small won't be able to handle the system flow rate and will create excessive pressure drop from the start. The results could be filter operation in the bypass mode, filter failure, component malfunction, or catastrophic system failures. Filters that are too large for the system can be too costly. Oversized filters require more system fluid and higher cost replacement elements. Optimal sizing is best.

Viscosity/Temperature Chart

A.S.T.M. Standard Viscosity-Temperature Chart for Liquid Petroleum Products (D 341-43) Saybolt Universal Viscosity

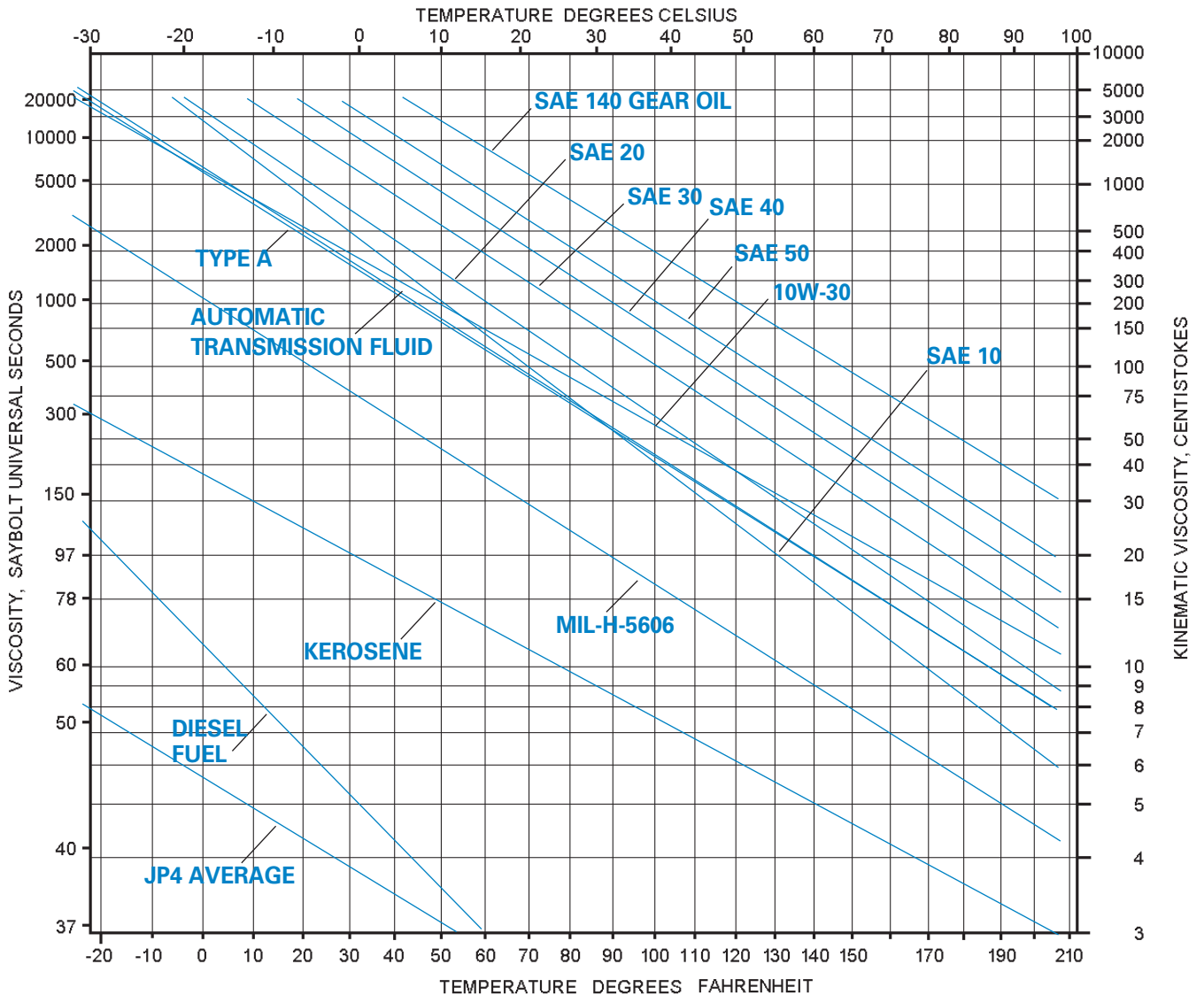

ENGINE LIQUID FILTRATION - TECHNICAL REFERENCE

Combining the ISO Rating and Filter Performance Ratings

Many of the components with filters have recommended or specified fluid cleanliness levels to ensure their performance and longevity. This is usually specified per ISO 4406 and with a three number rating expressed in x/y/z format. In this rating each number is a code representing the number of particles greater than a certain size. In the example above x is a code representing the number of particles greater than 4 micron, y greater than 6 micron and z greater than 14 micron (see ISO rating system below for more details). While filters, on the other hand, have a given efficiency performance based on the media used which is usually expressed in a beta rating or efficiency percentage. A direct connection between the beta rating scale and the ISO rating scale cannot be made.

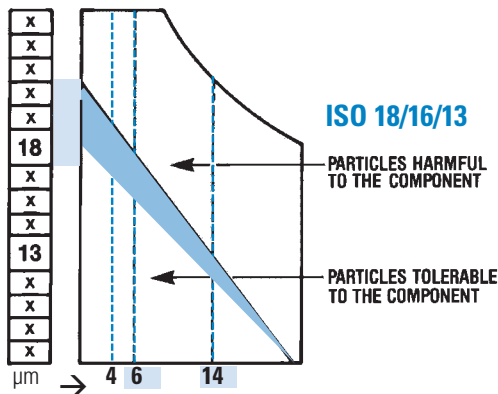

Many application differences exist in engine liquid filters that need to be understood to begin to correctly apply a filtration media to obtain a desired fluid cleanliness. For example, is it a contained system like the lube oil system where the same fluid is re-circulated and the fluid will be put through the filter multiple times (multi-pass) or is it a fuel system where the fluid is consumed and needs to be cleaned in one time through the filter (single pass). What is the fluid cleanliness that is being started with and what are the application environmental conditions. These are just a few of the things to consider when choosing the correct media to apply.

The ultimate solution is monitoring filter media performance at removing particles in the 4 μm, 6 μm, and 14 μm ranges. Fluid analysis and field monitoring are the only ways to get these measurements. Combine data from several tests to form a range of performance. Remember, actual filter performance will vary between applications.

ISO Rating System

The international rating system for fluid contamination levels is called the ISO contamination code and it is detailed in the ISO 4406 document. Many component manufacturers publish filtration level recommendations using the ISO code. Manufacturer's ISO contamination levels are based on controlling the particle counts of 4 μm, 6 μm and 14 μm particles in the system fluid. This level is identified by measuring the number of particles 4 μm and greater, 6 μm and greater, and 14 μm and greater in one milliliter of the system fluid sample.

ISO 4406 Contamination Codes

Range of number of particles per milliliter

Code	More Than	Up to & Including
24	80,000	160,000
23	40,000	80,000
22	20,000	40,000
21	10,000	20,000
20	5,000	10,000
19	2,500	5,000
18	1,300	2,500
17	640	1,300
16	320	640
15	160	320
14	80	160
13	40	80
12	20	40
11	10	20
10	5	10
9	2.5	5
8	1.3	2.5
7	.64	1.3
6	.32	.64
5	.16	.32
4	.08	.16
3	.04	.08
2	.02	.04
1	.01	.02

Filter Efficiency Ratings

This information is provided as an aid to understanding fluid filter efficiency terminology based on current ISO and SAE test standards. It is not proprietary and may be reproduced or distributed in any manner for educational purposes.

What is Beta Ratio?

Beta ratio (symbolized by β) is a formula used to calculate the filtration efficiency of a particular fluid filter using base data obtained from multi-pass testing.

In a multi-pass test, fluid is continuously injected with a uniform amount of contaminant (i.e., ISO medium test dust), then pumped through the filter unit being tested. Filter efficiency is determined by monitoring oil contamination levels upstream and downstream of the test filter at specific times. An automatic particle counter is used to determine the contamination level. Through this process an upstream to downstream particle count ratio is developed, known as the beta ratio.

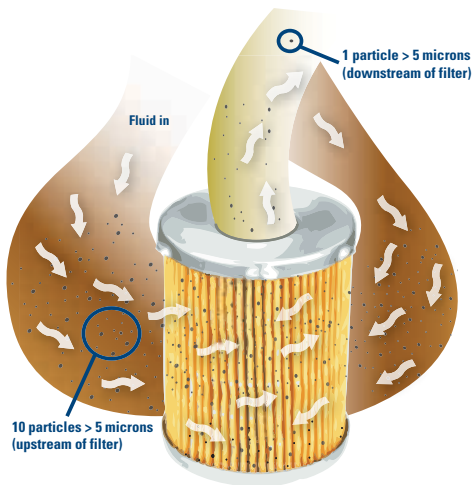

The formula used to calculate the beta ratio is:

$$\text{Beta ratio}_{(x)} = \frac{\text{particle count in upstream oil}}{\text{particle count in downstream oil}}$$

(x) is a given particle size

$$\beta_{(5)} = 75$$

Efficiency

The beta ratio is commonly used to calculate the filtration efficiency of a filter and can be converted into a percentage of efficiency at a give particle size. The formula below was used to calculate the performance of filters in this catalog.

$$\text{Efficiency}_{(x)} = \frac{\beta - 1}{\beta}$$

(x) is a given particle size

β	Efficiency
2	50 %
5	80 %
10	90 %
20	95 %
75	98.7%
100	99 %
1000	99.9%

β 75 is 98.7% for particles 5 μ m and greater

$\beta_{(5)} = 75$ is same as 98.7% @ 5 μ m

Micron Sizes of Familiar Particles

Grain of table salt	100 μ m
Human hair	80 μ m
Lower limit of visibility	40 μ m
White blood cell	25 μ m
Talcum powder	10 μ m
Red blood cell	8 μ m
Bacteria	2 μ m
Silt	<5 μ m

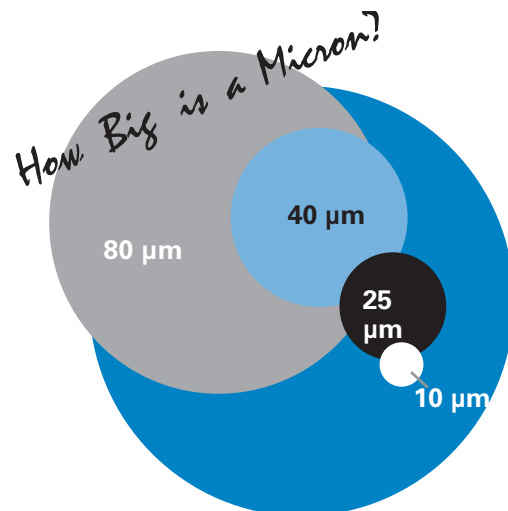

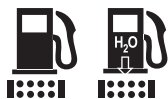

What is Biodiesel?

Biodiesel is a clean-burning alternative fuel made from renewable resources. Biodiesel can be made from soybean oil, other vegetable oils, recycled frying oils and animal fats. The term ‘biodiesel’ refers to the pure, unblended alternative fuel and is referred to as B100. The term “diesel” refers the all petroleum-based diesel fuel.

Biodiesel contains no petroleum, but it can be blended with petroleum diesel in any percentage. Biodiesel blends from 2 percent to 20 percent can be used in most diesel equipment with no or minor modifications.

Are there standards for Biodiesel?

There are standard setting bodies such as the American Society for Testing and Materials (ASTM) and specifications such as Biodiesel Specification, D6751, that define strict quality standards that biodiesels need to meet for approval for distribution as fuel to ensure trouble-free performance. There is also a new standard for biodiesel blends, ASTM D7647 for B6 through B20; ASTM D975 covers petroleum diesel with blends of biodiesel up to B5.

What is not Biodiesel?

Unprocessed, raw vegetable oils and animal fats are NOT biodiesel – they can cause deposits and engine damage. In addition, these substances are not registered fuels approved by the U.S. Environmental Protection Agency (EPA).

How do you know if fuel contains Biodiesel?

Biodiesel blends are indicated by a “B” with a number following the “B” that represents the percentage of biodiesel in a gallon of fuel. The remainder of the gallon can be No. 1 diesel, No. 2 diesel, kerosene, jet A, heating oil or any other distillate fuel. If the biodiesel concentration is higher than B5 the fuel pump should have a label disclosing the biodiesel content.

How do you know if your diesel equipment can use Biodiesel?

Biodiesel blends higher than B20 require special handling and may require equipment modifications. As a result, higher level blends are not recommended except in cases where human exposure to diesel particulate matter (PM) is high and health concerns merit the additional attention to equipment and handling (e.g., underground mining). Before switching to a biodiesel blend it is best to contact the Original Equipment Manufacturer (OEM) to make sure the desired level of biodiesel will not void the warranty.

What are some of the common problems and solutions to help, reduce or eliminate problems related to Biodiesel?

A specific user may have one or multiple causes to their fuel system problems, including:

(1) biodiesel, (2) petroleum diesel fuel, (3) various types of contamination and deposits, and (4) problems with storage vessels and fuel delivery system components including improper filters or the lack of filters in the system or any number of similar problems with vehicles. To help reduce these problems it is best to ensure the fuel you are receiving is of the highest quality and that the storage tanks (bulk and on the truck) are clean and free of water. Also double check that all the fuel filters in the system are sized properly and agree with the manufacturers recommendations.

What should you consider when switching to Biodiesel?

- Is the fuel system compatible with the biodiesel blend you will be using?
- Are you going to be operating in cold weather?
- Do you have a reliable source for qualified biodiesel?
- Is the storage tank clean, free of water and compatible with your biodiesel blend?
- Are you going to use up the fuel in your storage tank within six months of the original manufacturing date of the biodiesel?
- What does the Original Equipment Manufacturer (OEM) recommend?

What is the Cloud Point?

The temperature at which the first solids form and are visible to the naked eye. This is the most commonly used measure of low-temperature operability; fuels are generally expected to operate at temperatures as low or lower than their cloud point. Biodiesel typically has a higher cloud point than petroleum diesel.

What is the Cold Filter Plugging Point (CFPP)?

This is the temperature under a standard set of test conditions (ASTM D6371) at which the filter plugs. The sample is cooled and tested at intervals of 1°C until the wax crystals precipitate out of solution and are sufficient to slow or stop the flow of fuel through the filter.

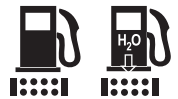

How would an operator know if a fuel system is compatible with the biodiesel blend being used?

Before switching to a biodiesel blend it is best to contact the Original Equipment Manufacturer (OEM) to make sure the desired level of biodiesel will not void the warranty. To determine the compatibility operators can run several tests on a particular fuel system and the biodiesel blend being used including the following:

Cetane Number – Measures the ignitability or ignition quality of the fuel. Biodiesel has a higher cetane value which can affect the engine performance.

Volatility – Measures the tendency for a fluid to evaporate. Diesel fuel has a low volatility and the fuel system is very tolerant to a wide range of volatilities. Biodiesel does have a higher volatility which if measure beyond the acceptable range could lead to increased engine deposits.

Viscosity – Measure how well the fluid flows; this value is very important for injector systems because it can affect the spray pattern out of the injector. Biodiesel can have a much wider range of viscosities so it is best to test to make sure it is meeting specifications.

Low Temperature Operability – Measures the cold weather properties of the fuel and its ability to flow at cold temperatures. Biodiesel is more vulnerable to gelling at higher temperatures than petroleum based fuels.

Lubricity – This test measures the wear caused by friction between metal parts. Fuel system components are lubricated by the fuel itself. Wear or scarring is a sign of inadequate lubricity. Poor lubricity can result in shorter life of components. Biodiesel can be used as a lubricity improver.

Material Compatibility – (Copper Strip Corrosion – This test indicates potential compatibility problems with fuel system components made of copper alloys such as brass and bronze.) Biodiesel may not be compatible with all materials so it is best to test the entire fuel system to ensure no failures will occur. The material suppliers should be able to assist in the material testing or may have already completed the necessary material testing to qualify their materials.

Water and sediment – This refers to free water droplets and sediment particles. The allowable level for B100 and B6 to B20 blends is set at the same level allowed for conventional diesel fuel. Excess water can lead to corrosion and provides an environment for microorganisms. Fuel oxidation can also raise sediment levels, so this test can be used in conjunction with acid number and viscosity to determine if fuels have oxidized too much during storage. It is important to note that biodiesel can absorb a lot more water than petroleum diesel so this is a test that should be run frequently to ensure the fuel is not out of specification.

What is a recommended best practice to avoid biodiesel related fuel problems?

The vendor and fleet manager should establish a contractual agreement to ensure product quality on a consistent basis. Ensure that the fuel you purchase meets industry standards such as the ASTM specifications D6751 for B100, D7647 for B6 through B20 and D975 for petroleum diesel, and that it is properly blended to the predefined biodiesel blend target upon receipt. Choose biodiesel marketers and producers that have attained National Biodiesel Board BQ-9000 quality program accreditation. If you cannot source fuel from a BQ-9000 producer/marketer, the next best thing is to verify with your supplier that each load of fuel meets all ASTM specifications.

Retain a one-quart sample of fuel. Look at a sample of the fuel in a clear mason jar. The fuel should be clear and bright. Save this sample until the next load of fuel is received. Discard the sample by adding it to the fuel tank.

Is there a shelf life for biodiesel fuel?

As with any ULSD, biodiesel has a shelf life of 6 months to avoid microbial growth and product degradation. With the proper housekeeping and additives, the shelf life can be extended. Consult your fuel supplier for proper recommendations and testing. Stability additives may be needed if fuel is to be stored for longer than six months. Biodiesel is less stable than petroleum fuels. Exposure to air, heat, light, water and some metals are contributing factors that will cause it to degrade. A common symptom encountered with degraded fuel is plugged filters. With the proper housekeeping and additives, the shelf life can be extended. Consult your fuel supplier for proper recommendations and testing.

What do you need to do during cold weather months?

When you receive fuel, determine how long it will be in storage. Fuel purchased in July does not contain cold flow additives. If you will be using this fuel in winter months, you may need to add cold flow additives. Like regular diesel fuels, biodiesel blends will gel in very cold temperatures. Typically No.2 diesel fuel has a cloud point in the range of -10 to 20°F and No.1 diesel fuel has a cloud point -40°F or less. That means without the use of cold flow improving additives, No.2 diesel will begin to gel and plug filters at their cloud point. Blends of No.1 and No.2 diesel fuel, the use of cold flow additives and/or fuel heating systems are frequently used to meet cold flow operability requirements for the temperatures expected. The cold flow properties of biodiesel blends up to 5% will be virtually the same as those of the diesel fuel used in the blend. Biodiesel blends over 5% will begin to have higher cloud points and require the use of cold flow additives or No.1 diesel in order to operate in cold winters.

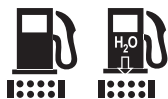

How should biodiesel be stored?

Underground storage tanks are preferred to avoid temperature extremes. Above ground storage tanks should be sheltered or painted with reflective paint. High temperatures during storage accelerate fuel degradation. Brass, bronze, copper, lead, tin and zinc may accelerate the oxidation of diesel and biodiesel fuel and potentially create sediments, gels or salts when reacted with some fuel components. Acceptable storage materials include stainless steel, aluminum, Teflon® and most fiberglass. Lead solders, zinc linings, copper pipes, brass regulators and copper fittings should be avoided.

How do you check fuel tanks for water and sediment?

To ensure contaminants do not create fuel quality issues it is important to remove them before they buildup. The best way to check the tank is to retrieve a sample from the lowest point of the tank. For bulk storage tanks this can be done with a bacon bomb or by drawing a sample off the lowest point of the tank. It is also a good idea to check the on-board tanks; this can be done by drawing a sample from the lowest point with a sample kit. Every fuel system has the potential to experience problems so it is necessary to check frequently for contamination. Every fuel system should be inspected per federal, state and local regulations. In addition to those inspections it is necessary to look for contamination. It is recommended that a storage tank be checked for water and sediment prior to each fuel delivery. If the frequency of the deliveries is such that months go by between them, then check the fuel tank at least once a month. If contamination is found, it should be removed as soon as possible. Water should be removed either by draining water off the tank if it is equipped with a water draw or with a vacuum truck. Whichever method is used, the removal should be done slowly so that free water can travel to the low point in the tank. A visual inspection of the water and fuel should be done at the same time and continued until the fuel is clear and bright.

Why are fuel tanks checked for Microbial Contamination?

It is necessary to test for microbial contamination because the microbes can lead to filter and pump failures. It is recommended that fuel tanks be tested for microbial contamination twice a year, preferably in the fall and spring. To test for microbial contamination, obtain a quart sample from the tank bottom. Contact your fuel distributor about performing a microbial test. Many fuel distributors perform this test for a fee or can give a referral to a reputable lab that can perform testing. The costs associated with routine testing is a small price to pay in relation to the cost of fuel in the fuel tank, the cost to have vehicles go down due to filter plugging and the cost of biocide used to treat microbial contamination.

How are fuel tanks cleaned?

If sediment is found then a vacuum truck should be used with a scavenger device to effectively navigate around the tank and remove the contamination. Depending on the severity of the contamination, an internal tank cleaning may be necessary to effectively remove contaminants. Tank cleaning should take place one of two ways; (1) with the use of a high pressure hose with fuel, or (2) by physically scrubbing the inside of the tank. Both cleaning methods will use impingement cleaning, meaning all surfaces are cleaned with either high pressure or physical scrubbing.

How can fuel filtration prevent problems with biodiesel fuels?

When switching to biodiesel, some users have experienced problems with premature fuel filter plugging. This is not an issue at low level biodiesel blends but more commonly seen with blends of B20 or higher.

Fuel filters are designed to remove water and particulate from fuel in order to protect the fuel system. They are designed to eventually plug. You may want to investigate if you continue to have a change in the frequency of filter changes.

The Original Equipment Manufacturer (OEM) has specified filters for each fuel system to provide optimum performance. When replacing the filters, it is strongly recommended to continue to use the OEM filters or the equivalent aftermarket filters. OEM is not the local mechanic. Check with the OEM headquarters.

Fuel filtration will be affected by multiple factors including:

Stability issues—A common symptom encountered with degraded fuel is plugged filters. Solution—proper housekeeping and the use of additives can extend the shelf life of biodiesel fuel. Consult your fuel supplier for proper recommendations and testing.

Cold Flow – Biodiesel has a much higher cloud point/pour point than petroleum diesel fuel. Pure biodiesel can start to cloud at 55°F and gel by 32°F. Make sure proper cold flow is being requested for the desired region of operation.

Water Separation – Water is present in fuel and therefore many fuel systems require a method of water removal before it reaches the fuel injectors. Be sure to drain water separators daily to ensure optimum performance.

Cleaning/Solvent Effects – Biodiesel (B100) is an excellent solvent for cleaning any hydrocarbon deposits that may have formed in the fuel system. After switching to biodiesel it is expected that fuel filters may plug quickly to begin with and then return to a normal change interval after the fuel system is cleaned.

Microbes – Microbes is a broad description for any biological growth that can occur in the fuel with the presence of water. They are becoming a more common problem in diesel fuel because the ultra low sulfur levels do not inhibit their growth as in the days of high sulfur diesel. The microbes can form a film of sediment that can plug fuel filters.

What should you consider when choosing a fuel filter for biodiesel?

When choosing a filter it is important to consider the original specifications. It is best to continue to use the same style and efficiency filter. If it is not obvious what the performance level of the current filter is, try searching the internet or calling the manufacturer. Filters are typically rated in either a percentage or a beta ratio.

The efficiency of the filter is very important because it is the level of filtration that must be maintained to ensure no damage is done by hard or abrasive particles. If a lower efficiency filter is installed it can cause premature engine wear and damage. If a higher efficiency filter is installed, it can cause performance issues such as power loss, fuel flow problems and frequent filter plugging.

What additional steps can be taken to minimize filtration related problems with biodiesel fuels?

It is highly recommended to add a filter to bulk storage tanks. This will help remove water and particulate contamination before they reach the vehicle. There are two ways to add filters to storage tanks, the first is a side filtration loop and the second is in-line with the fuel pump, between the tank and the vehicle fill. A side filtration loop could be a separate recirculation pump that pushes the fuel through a series of filters to keep it clean and then put the fuel back into the tank. A dispenser filter filters all of the fuel that goes into the vehicle so less contaminant reaches the fuel tank on the vehicle. This type of filtration can be a good signal for bad fuel; the pump filter will plug up and signal that it is seeing a lot of contamination and that contamination will not reach the vehicles. Both types of filtration can be utilized to provide more efficient filtration than the vehicle requires by capturing more contaminant.

Key points to remember about biodiesel fuel:

- Fuel filters used today are generally compatible with biodiesel blends up to B20
- Most plugging problems can be traced back to the fuel quality
- Recommendations to minimize plugging problems include:
 - Applying bulk filtration on storage tanks.
 - Implementing a preventative maintenance program.
 - Requesting compliance documentation from your fuel supplier.
 - Adding a fuel water separator to older vehicles if not already equipped.

Filtration for Alternative Fuels: CNG, LPG & LNG Systems

CNG = Compressed Natural Gas

LPG = Liquid Propane Gas Engines

LNG = Liquid Natural Gas Engines

Donaldson has fine filtration assemblies that meet the need of CNG, LPG, and LNG systems. Using a filtration system designed for the pressures of the applications where these alternative fuels are used; Donaldson has proven experience building assemblies that match the specified need.

Contaminants in Alternative Fuel Systems are similar to those of Diesel fuel. However, systems use higher operating pressures in the filter assembly, have various means of exposure to condensation generation in the system, and contain a range of critical components sensitive to contaminant. Along with water, systems can fall victim to oil ingestion and particulate matter induction.

Aside from alternative fuel filtration, Donaldson offers air filtration, and oxidation catalyst products to help you build your system complete. Complementing our fuel filtration assemblies and making us a leader in the development of Alternative Fuel Filtration Systems. Consult with Donaldson on how your system is designed to meet the needs of toughening emissions requirements.



Oil Analysis

Oil analysis service provides tests necessary for effective preventive maintenance. Oil analysis evaluates the results of the tests performed to provide detailed reports of oil condition and specific maintenance requirements. Data can be used to improve preventive maintenance, reduce equipment downtime and identify potential to extend oil drain interval.

The following is an aide for understanding the terminology and application of routine oil analysis.

Fuel Dilution (% by volume)

The amount of unburned fuel present in a sample of crankcase oil. High fuel dilution is generally caused by excessive idling, improper adjustment, and/or faulty components within the fuel delivery system.

Fuel Soot (% mass)

An accurate measurement of the dispersed fuel soot present. Performed by Light Extinction Measurement (LEM) and reported as % mass, soot levels are indicative of air/fuel ratios, fuel delivery and valve settings, and combustion/exhaust efficiency. The state of the fuel soot depicts dispersant additive effectiveness

Infrared Analysis

Organic compounds present in lubricating oils will absorb infrared light at specific frequencies. The most common frequencies measured in oil analysis indicate fuel soot, oxidation, nitration, water and glycol. Reference (new oil) samples are required for effective determination and interpretation.

- Fuel Soot is a relative measure of the insoluble carbon present in the lubricant which is applied to evaluating combustion efficiency.
- Oxidation is the degradation of oil when molecules chemically combine with oxygen. Oxidation is part of the normal aging process which can be accelerated by increased temperature and the presence of acids. Oxidation increases viscosity and contributes to sludge and varnish deposits.
- Nitration, in the form of nitrogen oxides, is formed during the combustion process and when combined with moisture forms nitrous acid. Nitration is indicative of ring blow-by, can be corrosive, and contributes to oxidation and increased viscosity.
- Water is measured and reported as percent by volume.
- Glycol. Appraised for the presence of glycol based coolant and reported as Positive or Negative.

Water (% by volume)

The amount of water suspended in a lubricant can be detected at levels as low as 0.05% by volume. This test is performed by the hot plate "crackle" method. Water content is evaluated in conjunction with other related tests for identification (fresh, salt, coolant, etc.) as well as probable source.

Water (parts per million by weight)

The amount of water suspended in a lubricant as measured by the Karl Fischer titration method and expressed in parts per million (ppm) by weight. This method measures water levels down to 1 ppm and is generally applied to fluids from systems which have a low water tolerance or low water requirements (refrigeration compressors, hydraulic systems, turbine oils, etc.).

Viscosity

The measurement of a fluid's resistance to flow at a given temperature in relation to time. Viscosity measurements are used to determine a fluid's classification by grade, and may indicate level of dilution, shearing, oxidation, and/or product contamination.

Neutralization Number

A number expressed in milligrams of reagent required to neutralize one gram of lubricant. The neutralization number is measured and reported as either a Total Acid Number (TAN) or Total Base Number (TBN), depending on the lubricant and application.

- Total Acid Number (TAN) is a measure of the total amount of acid products present in the lubricant. Generally, an increase in TAN above that of the new product is an indication of contamination by an acidic product or the result of oil oxidation.
- Total Base Number (TBN) is a measure of the alkalinity remaining in a lubricant. A relatively low TBN, or a decrease in TBN compared to the new product, indicates low acid neutralizing characteristics or a depleted additive package.

Particle Count

A numerical count of particles present in a lubricant which are measured within specific particle size ranges. This test is generally associated with fluids which require the controlled filtration of particles 50 microns or less in size (e.g. hydraulic systems).

The next few pages cover Frequently Asked Questions (FAQs) for fuel, lube and coolant filtration. The source is the Filter Manufacturers Council at www.filtercouncil.org. Donaldson is a participating member in this organization.

Fuel Filtration

- What is the meaning of efficiency in relation to a fuel filter?
- What is the capacity of a fuel filter and how is it measured?
- What is restriction?
- What is hydrostatic burst pressure?
- How often should system maintenance be performed?
- How can I estimate my engines total fuel flow rate?
- What is the difference between a primary and secondary diesel fuel filter?
- What is the purpose a fuel/water separator?
- What is asphaltene?
- What is a micron?
- How often should I change my fuel filter(s)?

Lube Filtration

- Can the filter cause low oil pressure?
- What causes a gasket to displace from the oil filter?
- Is it better to use a filter with higher efficiency, regardless of the capacity of the filter?
- Can some filters be substituted for other filters?
- What is the difference between a by-pass lube filter and a full-flow lube filter?
- What is the purpose of a by-pass lube filter? What is the micron rating and efficiency of the filter?
- What type of media does the filter use?
- What are the advantages of glass media?
- What is the service interval of the filter?
- Do the liquid and solid additives last the same amount of time?

Coolant Filtration

- How often should system maintenance be performed?
- How can I obtain Material Safety Data Sheets (MSDS) for coolant additives?
- Are there environmental hazards to not treating a coolant system properly?
- Why doesn't a coolant filter come factory installed on some engines?
- Is regular tap water all right to use in coolant systems?
- How can I convert "normal" additives to extended drain or extended service additives?
- I've never had cooling system problems. Why do I need coolant additives and filters?
- How often do I need to monitor the system? How do I control monitoring when vehicles are traveling nationwide?
- Can liquid SCAs and filters with SCAs be used together?
- What is the difference between filters that are the same physical size and have the same thread size?
- What is the difference between extended drain and extended service products?
- What is the correct water and antifreeze mixture to be used in coolant systems?
- Coolant seems to disappear from my system. Where does it go?
- Why does my coolant foam?
- What happens if the coolant system is overcharged with additives?
- Should I consider using coolant filters on gasoline engines?
- Are additives and filters with additives compatible with long life / extended life coolant?
- What is the best way to determine the freeze point of the coolant?
- How often should I change my antifreeze?
- Can I use a liquid SCA in either a gasoline or diesel engine with no coolant filter?
- Is it better to use a filter with coolant additive or a liquid SCA with an additive free filter?
- Why can't I use a bigger filter with SCAs?
- Will adding SCAs to a coolant system postpone or cure existing corrosion problems?
- What types of coolant cleaners / flushes should be used?
- If I change vehicles or equipment, can I use up my existing filters with SCAs?
- How do I find out what the total coolant capacity of my system is?
- Do supplemental coolant products work with recycled antifreeze?
- Do you really need to test between service intervals?
- What does the additive actually do while circulating in the coolant system?
- Which brand of antifreeze is low silicate type?

Q: What is the meaning of efficiency in relation to a fuel filter?

Efficiency is the ability of the filter to remove particulate (% efficient) at a given micron (size). The type of media being used ultimately defines the filter's efficiency.

Q: What is the capacity of a fuel filter and how is it measured?

Capacity is the measurement (in grams) of the total amount of containment a filter can retain at a rated flow and given end-point (restriction). The type of media (i.e. glass, cellulose, synthetic, etc.) and the amount (square inches) of media defines capacity.

Q: What is restriction?

Restriction is the pressure drop across the filter at a given flow, temperature, and fluid viscosity. The type of media and general filter construction defines restriction.

Q: What is hydrostatic burst pressure?

The hydrostatic burst pressure of a filter is its ability to withstand a deadhead pressure and is typically measured in pounds per square inch. The type of lock-seam, material thickness (bottom and body of filter), shape of tapping plate, and gasket contribute to hydro performance.

Q: How often should system maintenance be performed?

This is totally dependent on the type of SCA you have chosen to use. Refer to engine and additive manufacturer recommendations.

Q: How can I estimate my engines total fuel flow rate?

If this information is not available from your engine or equipment manufacturer, use the following formulas for estimating purposes.

Diesel or kerosene fuel systems:

Gallons per Hour is Engine Horsepower (maximum) multiplied by 18% or $GPH = HP \times 0.18$

Gasoline fuel systems (carbureted):

Gallons per Hour is Engine Horsepower (maximum) multiplied by 10% or $GPH = HP \times 0.1$

Gasoline fuel systems (fuel injected):

Use a straight 40 GPH figure.

Q: What is the difference between a primary and secondary diesel fuel filter?

The primary fuel filter must offer low restriction because it is mounted on the suction side of the fuel pump where normally a suction pressure of only 5-6 pounds per square inch is available. This filter has the job of protecting the transfer pump and lightening the load of the secondary fuel filter (if installed). Primary fuel filters typically have a nominal rating of 10 - 30 microns.

Secondary fuel filters are mounted between the transfer pump and the injectors. The secondary fuel filter is designed to offer full protection to the fuel injectors. Since these filters are mounted after the transfer pump they tend to see much higher pressures than primary filters. Secondary fuel filters typically have a nominal rating of 2 - 10 microns.

Q: What is the purpose a fuel/water separator?

Water flowing at high velocity between highly polished valve seats and through fine nozzle orifices causes a wearing action that approaches that of abrasion. The presence of water, especially with entrained air and various fuel components, causes rust and other chemical corrosion that eats away at the finely mated surfaces. Fuel/water separator filters use chemically treated paper to repel water which then settles by gravity to the bottom of the filter. Accumulated water can be drained from the filter during recommended service intervals if equipped with a drain valve or plug.

Q: What is asphaltene?

All diesel fuels to a degree contain a substance known as asphaltene. Asphaltene is a by-product of fuel as it oxidizes. Asphaltene particles are generally thought to be in the half micron - 2-micron range and are harmless to the injection system, as they are soft and deformable. As these tiny particles pass through the filter media they tend to stick to the individual fibers. If you were to cut open a filter that had choked after a normal service interval you would see a black, tarry substance on the dirty side of the filter; this is asphaltene (oxidized fuel).

Q: What is a micron?

The common unit of measurement in the filtration industry is the micron or micrometer. One micron equals forty millionths of an inch (.00004). In comparison, a human hair is approximately 70 micrometers.

Q: How often should I change my fuel filter(s)?

Always follow the equipment or engine manufacturers recommendation on change intervals. The type of equipment and its usage will determine how often the filters need to be changed.

Q: Can the filter cause low oil pressure?

While some pressure drop across the filter is normal, the oil filter is not capable of regulating the lube system pressure. Low oil pressure is generally the result of another malfunction in the engine such as the oil pump losing its prime or the pressure-regulating valve not functioning properly. Reference FMC TSB 83-2R2

Q: What causes a gasket to displace from the oil filter?

Gasket displacement is the result of insufficient gasket compression during installation, excessive lube system pressure or a combination of the two. Any deformation to the filter, from which the gasket was displaced, is a clear indicator that the filter was exposed to excessive lube system pressure. Excessive lube system pressure is most likely the result of a malfunctioning pressure regulating valve that is failing to open properly. Reference FMC TSB 99-1R2

Q: Is it better to use a filter with higher efficiency, regardless of the capacity of the filter?

The correct filter for an application will have a good balance between efficiency and capacity for the application that it is used in. Using a filter with very high efficiency may lower the dirt holding capacity of the filter enough to shorten the life of the filter on the application, increasing the risk of the system going into by-pass.

Q: Can some filters be substituted for other filters?

This question is presented when customers are trying to consolidate some of the filters that they carry. The filter manufacturers will not approve of such consolidation. While there are some filters that may work in the place of others, filter manufacturers recommend against consolidation, because each filter is designed after a specific OEM filter. Additionally, if changes are made to a specific filter to keep it up to date with the OEM filter that it replaces, it may no longer be an acceptable substitute for another filter that it could be used in place of, previously.

Q: What is the difference between a by-pass lube filter and a full-flow lube filter?

The oil that goes through the full-flow lube filter goes on to lubricate the engine. The by-pass lube filter receives about 10% of the amount of oil that flows through the full-flow filters and filters that oil at a much higher efficiency. The oil that flows through the by-pass lube filter then returns to the sump. Due to the high efficiency of the by-pass lube filter, it cannot handle the same volume of flow as the full-flow filter. A metering orifice is commonly used to meter the flow of oil through the by-pass filter.

Q: What is the purpose of a by-pass lube filter?

A by-pass lube filter is used to continually filter the oil in a system at a higher efficiency to remove contaminant that is not efficiently removed by the full-flow filter.

Q: What is the micron rating and efficiency of the filter?

The micron rating of a filter represents the size of particle that the filter can remove from the fluid passing through it. The micron rating should be associated with an efficiency or beta value to indicate how efficient the filter is at removing that size of particle. Any given filter will remove various sizes of particles. The difference between filters is how efficient they are at removing certain sizes of particles.

Q: What type of media does the filter use?

There are many different types of media that can be used in lube filters. Earlier filters used a depth type media, that type of media is still used in some filters today. Most lube filters now use pleated cellulose or cellulose blended media. Some lube filters in specialized applications use synthetic media (glass) or glass-blended media.

Q: What are the advantages of glass media?

Glass media has more uniformity in the size of the opening in the media, which can provide for better flow performance. Glass media also has more dirt holding capacity per square inch of media than most cellulose media blends.

Q: What is the service interval of the filter?

After-market filter manufacturers design their filters to meet or exceed the performance requirements of the original equipment manufacturer, for which the filter is applied. Therefore, the use of an after-market filter will not affect the service interval recommendations of the original equipment manufacturer.

Q: Do the liquid and solid additives last the same amount of time?

Yes, when equivalent amounts of supplemental coolant additives (SCA) are added.

Q: How often should system maintenance be performed?

This is dependent on the type of SCA you have chosen to use. Refer to engine and additive manufacturer recommendations.

Reference FMCTSB 02-1 for further details.

Q: How can I obtain Material Safety Data Sheets (MSDS) for coolant additives?

MSDS information is available from the coolant additive manufacturer or your filter manufacturer.

Q: Are there environmental hazards to not treating a coolant system properly?

There are no “environmental” hazards. There are definitely mechanical hazards related to incorrect coolant system maintenance procedures. (Water pump failures, wet sleeve cavitation erosion and pre-mature catastrophic engine failures.)

Q: Why doesn't a coolant filter come factory installed on some engines?

Due to various engine designs, some engine and equipment manufacturers do not require coolant filtration. Coolant filtration can be added to these systems to prolong water life and/or aid with coolant maintenance.

Q: Is regular tap water all right to use in coolant systems?

Most tap water does not meet engine manufacturer's specifications for use in coolant systems. Please refer to OEM guidelines and consider a coolant analysis program to determine suitability when in question.

Reference FMCTSB 88-1R3 for further details.

Q: How can I convert “normal” additives to extended drain or extended service additives?

Each additive manufacturer offering extended service interval products can provide advice.

Q: I've never had cooling system problems. Why do I need coolant additives and filters?

It is very rare that a gasoline or diesel engine has “never” experienced a failure of a cooling system component, or a related part that couldn't have been prevented with the proper use of SCAs and a coolant filter. Both the short term and the long term economic benefits of properly utilizing SCAs and coolant filtration far out weigh the low initial investment for the appropriate coolant products and their installation.

Q: How often do I need to monitor the system? How do I control monitoring when vehicles are traveling nationwide?

Monitoring, or testing, SCA levels are critical to the over all success of any coolant system maintenance program. SCA level monitoring can be done very easily by using coolant testing. Testing should be done at the maintenance interval for the type of SCA being used to determine if more additives are actually needed to accurately track SCA depletion rates. Testing can also be done at any time between maintenance intervals.

Q: Can liquid SCA's and filters with SCA's be used together?

This depends on the total capacity of the cooling system. Most system capacities are of the size that either the liquid SCA or a filter with solid SCA is utilized. In larger capacity systems, however, both products are used for proper maintenance. Initial installation and maintenance instructions should always be consulted for proper product usage.

Q: What is the difference between filters that are the same physical size and have the same thread size?

The differences in products that “look” alike are whether or not the filter contains SCA and, if it does, the type and the cooling system volume it will treat.

Q: What is the difference between extended drain and extended service products?

If the SCA has the correct chemical formulation, the time required between total coolant system drain intervals can be extended beyond normal recommended intervals. The maintenance intervals to keep this product working effectively are not extended. Extended service interval products allow the service interval of the SCA to be extended beyond normal.

Q: What is the correct water and antifreeze mixture to be used in coolant systems?

The ideal mixture is 50% water and 50% antifreeze. The coolant mixture should never contain less than 40% antifreeze or more than 60% antifreeze. The water used must meet engine manufacturer's guidelines for use in their coolant systems.

Q: Coolant seems to disappear from my system. Where does it go?

Coolant can seem to "disappear" from the system due to the lack of a coolant recovery system, evaporation, hose and clamp leakage or seepage, water pumps and/or thermostats not functioning properly, improperly sealed, cracked or broken head gaskets, cracked cylinder heads or engine blocks, and leaking or seeping radiators, heater cores or oil coolers. The consistent use of oil analysis can help pinpoint some of these problems and help avoid catastrophic failures.

Q: Why does my coolant foam?

Foam in coolant is usually the sign of trapped air in the system, a leak on the suction side of the water pump, an improperly functioning water pump, low or no coolant in the coolant recovery tank, the lack of a coolant recovery system, the coolant system lack of appropriate SCAs or the combining of incompatible chemicals in the coolant system.

Q: What happens if the coolant system is overcharged with additives?

Over charging or over concentrating a coolant system with additives will result in the formation of solids. These solids will form deposits that drop out and clog passage ways in the system preventing proper heat transfer. These solids are also very abrasive and will permanently damage surfaces they come in contact with. If a coolant filter is in use, it will be quickly plugged up.

Q: Should I consider using coolant filters on gasoline engines?

Yes. The overall up time and usability of gasoline engines can be greatly increased by treating the coolant systems used with gasoline engines the same way diesel systems are. Due to the total capacity of most gasoline engine coolant systems, the use of a liquid SCA and an additive free filter is recommended.

Q: Are additives and filters with additives compatible with extended life coolant?

Check with additive and coolant manufacturer for recommendations.

Q: What is the best way to determine the freeze point of the coolant?

The most consistently accurate method to determine the freeze point of the coolant is the use of a refractometer. Alternative test methods can also provide an estimate of freeze point.

Q: How often should I change my antifreeze?

Antifreeze should be changed based on original equipment engine manufacturer's recommendations or with the use of full laboratory coolant analysis.

Q: Can I use a liquid SCA in either a gasoline or diesel engine with no coolant filter?

Yes. However we do recommend the use of an additive free filter on all coolant systems to remove all solid and liquid contamination. Coolant system maintenance should always be done as a complete package to be most effective.

Q: Is it better to use a filter with coolant additive or a liquid SCA with an additive free filter?

Which coolant maintenance set-up to use is entirely determined by user preference. When properly installed, pre-charged and maintained, both filters with SCAs and liquid SCAs used with additive free filters will offer the coolant system identical levels of protection.

Q: Why can't I use a bigger filter with SCAs?

Coolant filters with SCAs are different physical sizes because they may contain different amounts of additives. The proper amount of SCA to be used to either pre-charge or maintain the additive level in the coolant is determined by the total capacity of the coolant system. Using the incorrect filter can result in an under-charged or an over-charged system. Both of these situations result in improper coolant system performance and could lead to pre-mature failures.

Q: Will adding SCAs to a coolant system postpone or cure existing corrosion problems?

No. If the system is already in poor physical condition, it should be thoroughly cleaned and flushed before the introduction of SCAs. Once it is clean, the SCAs will keep it that way provided proper maintenance intervals are followed.

Q: What types of coolant cleaners / flushes should be used?

Original equipment engine suppliers should be consulted to determine what cleaning/flushing products they recommend for use in their systems

Q: If I change vehicles or equipment, can I use up my existing filters with SCA's?

The total capacity of the coolant system is the sole determining factor as to which filter with SCA's is to be used. If the new system's capacity matches the usage specifications of the filters you already have, the antifreeze being used is suitable for use with the filters in question and the filters are still in their original factory packaging, they can be used.

Q: How do I find out what the total coolant capacity of my system is?

The original equipment vehicle, engine or equipment manufacturer has this information available.

Q: Do supplemental coolant products work with recycled antifreeze?

The vacuum distillation recycling method is the only method accepted by original equipment manufacturers. Some processes return the antifreeze to the customer with SCA's already added. Before installing any products on the systems using recycled antifreeze, you must know whether it contains any SCA's. If it does, an additive free filter is all that is needed until the first service interval is reached. At this point to properly treat the system, you must know what type of SCA was used by the recycler.

Q: Do you really need to test between service intervals?

Yes. Leaks in the system could develop, other components that could allow contamination into the coolant system could fail, foreign substances or incompatible fluids could be introduced to the system or coolant system components such as the thermostat or water pump could fail. All of these situations will directly affect the ability of a properly treated coolant system to perform correctly. Periodic testing with test strips can help avoid the potentially catastrophic results of a system that is not protected.

Q: What does the additive actually do while circulating in the coolant system?

In a clean, properly treated system, the additive physically coats the metal components and protects them from scale build up, corrosion and cavitation erosion (liner pitting).
Reference FMC TSB 88-1R2

Q: Which brand of antifreeze is low silicate type?

Any antifreeze that meets GM-6038M or ASTM D-4985 specifications is considered low silicate antifreeze.



ENGINE FUEL FILTRATION SYSTEM APPLICATION DESIGN WORKSHEET

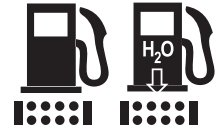

This form is intended to be filled out by an engineer or buyer that interested in a custom FUEL filtration design system.

Upon receipt of the form, Donaldson will assess your requirements and get back to you within three working days.

For proper development/design engineering solution, we ask you to provide details about your engine, project due dates, fuel system and performance (mechanical and filtration), system mounting, service, final packaging and product markings.

When completed, please forward to Donaldson.
Email: engine@donaldson.com
Fax: 952-887-3059

Company Name:		Revision:
Project Name:		
Contact Name:		Title
Phone:	Fax:	Email:
Current Donaldson Model Used: (if applicable)		Your Part Number:

Engine Information

Manufacturer _____
Model _____
Displacement _____
Number of Cylinders _____
Annual Volume _____

Key Project Dates:

Design Proposal: _____
Prototype Delivery: _____
Design Freeze: _____
PPAP: _____
Start of Production: _____

Fuel System Profile

Primary Filtration Secondary Filtration
Fuel Type:
 Standard grade _____
 Biodiesel and max. content _____
 Alternative: _____

Fuel Delivery System Brand: _____

Fuel Flow Rates: lpm or gpm
 Minimum _____ Normal _____ Maximum _____

Fuel System Pressure (kPa):
 Minimum _____ Normal _____ Maximum _____

Temperature: °C or °F
 Fuel: Min _____ Normal _____ Max _____
 Ambient: Min _____ Normal _____ Max _____

Fuel Heating Yes No
 Watts _____ Voltage _____

Priming Pump Yes No

Air Relief Valve Yes No

 **Water Separation** _____%
 Volume (ml) _____

 **Water Collection** Bowl No-bowl

 **Water Sensor** Analog Digital

Mechanical Performance

Hydrostatic Pressure Resistance (Burst):

Test Method : _____
 Minimum Value: _____ kPA

More on next page.

Collapse Pressure:

Test Method : _____
 Minimum Value: _____ kPA

Pressure Testing:

	Min. Cycles	Range (kPa)	Frequency (Hz)
Hydrodynamic		to	
Flow Fatigue		to	
Vibration		to	

Leak Testing:

Test Method : _____
 Minimum Value: _____ kPA

Filtration Performance

Test Conditions:

Method: _____
 Flow Rate _____ (l/min)
 Fluid Viscosity: _____ cSt
 Final Restriction: _____ (kPa)

Max. Initial Restriction:

_____ kPa @ _____ cSt

Avg Particle Efficiency

> ____ μm	> ____ μm	> ____ μm	> ____ μm

Min. Beta Ratio: $\beta(x) = Y$

X > _____ Y > _____

Minimum Capacity: _____ gms

Validation Tests For Special Fluids:

Mounting & Service

Assembly Mounting:

Side Top Bottom
 Other: _____

Filter Change Interval:

_____ km or miles or hours

Do you require installation, service or maintenance recommendations from Donaldson? Yes No

Inventory Managed by Donaldson? Yes No

Packaging

Do you have any special packaging requirements?

Yes No If yes, please check all that apply:
 Protective caps: on inlet on outlet on port

Final Assembly:

Bulk / Bagged Bulk/Individual Boxes
 Other _____

Product Markings

Do you have any product marking requirements?

Head Assembly? Yes No
 Filters? Yes No

If yes, artwork it is assumed customer will provide artwork for filter markings. Donaldson can provide marking area for artwork design. Standard installation icons are available from Donaldson.

Special Requirements or Application Notes

Use this area to provide additional information that will assist Donaldson engineering.

For Donaldson USE ONLY

Date Received: _____

Request From: Catalog Web Site
 Other _____

Assigned to:

Business Unit: _____
 Product Manager: _____

Account Manager: _____
 Engineer: _____



Donaldson Company, Inc.
 PO Box 1299
 Minneapolis, MN 55440-1200
 Engine Liquid
 Applications Engineering

Doc. No. F115345 Rev.0 August 2010
 © 2010 Donaldson Company, Inc. All rights reserved. Printed in the U.S.A.
 Donaldson Company, Inc. reserves the right to change or discontinue any model or specification at any time and without notice.

Donaldson Company, Inc., PO Box 1299, Minneapolis, MN 55440-1299



ENGINE LUBE FILTRATION SYSTEM APPLICATION DESIGN WORKSHEET



This form is intended to be filled out by an engineer or buyer that interested in a custom LUBE filtration design system.

Upon receipt of the form, Donaldson will assess your requirements and get back to you within three working days.

For proper development/design engineering solution, we ask you to provide details about your engine, project due dates, lube system and performance (mechanical and filtration), system mounting, service, final packaging and product markings.

When completed, please forward to Donaldson.
Email: engine@donaldson.com
Fax: 952-887-3059

Company Name:		Revision:	
Project Name:			
Contact Name:		Title	
Phone:	Fax:	Email:	
Current Donaldson Model Used: (if applicable)		Your Part Number:	

Engine Information

Manufacturer _____

Model _____

Displacement _____

Number of Cylinders _____

Annual Volume _____

Key Project Dates:

Design Proposal: _____

Prototype Delivery: _____

Design Freeze: _____

PPAP: _____

Start of Production: _____

Lube System Profile

Full Flow Filtration Bypass Filtration

Oil Type and Grade

Type: _____ Grade: _____

Oil Flow Rates: lpm or gpm

Min _____ Normal _____ Max _____

Oil System Pressure (kPa):

Minimum _____ Normal _____ Maximum _____

Temperature: °C or °F

Oil: Min _____ Normal _____ Max _____

Ambient: Min _____ Normal _____ Max _____

Oil Change Interval:

_____ km or miles or hours

Pressure Relief Valve: In Engine In Filter

Setting: _____ kPa

Anti-drain Back Valve: Yes No

Setting: _____ kPa Max. leak at valve _____ kPa

By-pass Valve: In Engine In Filter

Setting: _____ kPa

Mechanical Performance

Hydrostatic Pressure Resistance (Burst):

Test Method : _____

Minimum Value: _____ kPa

Collapse Pressure:

Test Method : _____

Minimum Value: _____ kPa

More on next page.

Pressure Testing:

	Min. Cycles	Range (kPa)	Frequency (Hz)
Hydrodynamic		to	
Flow Fatigue		to	
Vibration		to	

Leak Testing:

Test Method : _____
 Minimum Value: _____ kPA

Filtration Performance

Test Conditions:

Method: _____
 Flow Rate _____ (l/min)
 Fluid Viscosity: _____ cSt
 Final Restriction: _____ (kPa)

Max. Initial Restriction:

_____ kPa @ _____ cSt

Average Particle Efficiency (size & %)

> ___ μm	> ___ μm	> ___ μm	> ___ μm
%	%	%	%

Min. Beta Ratio: $\beta(x) = Y$

X > _____ Y > _____

Minimum Capacity: _____ gms

Validation Tests For Special Fluids:

Mounting & Service

Assembly Mounting:

Side Top Bottom
 Other: _____

Filter Change Interval:

_____ km or miles or hours

Do you require installation, service or maintenance recommendations from Donaldson? Yes No

Inventory Managed by Donaldson? Yes No

Packaging

Do you have any special packaging requirements?

Yes No If yes, please check all that apply:
 Protective caps: on inlet on outlet on port

Final Assembly:

Bulk / Bagged Bulk/Individual Boxes
 Other _____

Product Markings

Do you have any product marking requirements?

Head Assembly? Yes No
 Filters? Yes No

If yes, artwork it is assumed customer will provide artwork for filter markings. Donaldson can provide marking area for artwork design. Standard installation icons are available from Donaldson.

Special Requirements or Application Notes

Use this area to provide additional information that will assist Donaldson engineering.

For Donaldson USE ONLY

Date Received: _____

Request From: Catalog Web Site
 Other _____

Assigned to:

Business Unit: _____
 Product Manager: _____

Account Manager: _____
 Engineer: _____



Donaldson Company, Inc.
 PO Box 1299
 Minneapolis, MN 55440-1200
 Engine Liquid
 Applications Engineering

Doc. No. F115346 Rev.0 August 2010
 © 2010 Donaldson Company, Inc. All rights reserved. Printed in the U.S.A.
 Donaldson Company, Inc. reserves the right to change or discontinue any model or specification at any time and without notice.

Donaldson Company, Inc., PO Box 1299, Minneapolis, MN 55440-1299

Use this section to help guide you to the proper page in this product guide to find more information and details about a individual part. Product type descriptions are shown. Please note: part numbers may be referenced on multiple pages.

Part No.	Page No.	Product Description
DBC4081	112, 116	Coolant Filter, Extended Service
DBC4085	113, 116	Coolant Filter, Extended Service
DBC4085	116	Coolant Filter, Extended Service
DBC4086	112, 116	Coolant Filter, Extended Service
DBC4088	112, 113	Coolant Filter, Extended Service
DBC4088	116	Coolant Filter, Extended Service
DBC4089	112, 116	Coolant Filter, Extended Service
DBF5782	64	Fuel Secondary
DBL2501	102	Lube Filter, Full-Flow
DBL3998	85, 101	Lube Filter, Extended Service
DBL7300	85, 101	Lube Filter, Extended Service
DBL7345	85, 97	Lube Filter, Extended Service
DBL7349	85, 97	Lube Filter, Extended Service
DBL7367	85	Lube Filter, Extended Service
DBL7405	85, 101	Lube Filter, Extended Service
DBL7483	85, 100	Lube Filter, Extended Service
DBL7670	85, 95, 101	Lube Filter, Extended Service
DBL7690	85	Lube Filter, Extended Service
DBL7739	85, 100	Lube Filter, Extended Service
DBL7900	85, 102	Lube Filter, Extended Service
DBL7947	85, 101	Lube Filter, Extended Service
EFF0047	56, 64	Fuel Secondary
EFF7917	46, 61	Fuel Secondary
EFF9092	63	Fuel Primary
P115200	117	Clamp
P115201	117	Clamp
P143422	117	Clamp
P166481	105	Lube Cartridge, Full-Flow
P166564	98	Lube Filter, Full-Flow
P167670	101	Lube Filter, Full-Flow
P169071	98	Lube Filter, Full-Flow
P171371	117	Coolant Hose
P171372	117	Coolant Hose
P171373	117	Coolant Hose
P171374	117	Coolant Hose
P171375	117	Coolant Hose
P171376	117	Coolant Hose
P171377	117	Coolant Hose
P171378	117	Coolant Hose
P171379	117	Coolant Hose
P171380	117	Coolant Hose
P171381	117	Coolant Hose

Part No.	Page No.	Product Description
P171382	117	Coolant Hose
P171383	117	Coolant Hose
P171384	117	Coolant Hose
P171385	117	Coolant Hose
P171386	117	Coolant Hose
P171387	117	Coolant Hose
P171388	117	Coolant Hose
P171389	117	Coolant Hose
P171390	117	Coolant Hose
P171391	117	Coolant Hose
P171392	117	Coolant Hose
P171394	117	Coolant Hose
P171395	117	Coolant Hose
P172969	19	Filter Wrench
P172970	19	Filter Wrench
P172972	19	Filter Wrench
P172973	19	Filter Wrench
P172974	19	Filter Wrench
P172975	19	Filter Wrench
P176431	88	Oil Analysis Sampling Pump
P176433	88	Oil Analysis Plastic Tubing
P502007	96	Lube Filter, Full-Flow
P502008	101	Lube Filter, Combination
P502009	97	Lube Filter, Full-Flow
P502010	96	Lube Filter, Full-Flow
P502015	96	Lube Filter, Full-Flow
P502016	96	Lube Filter, Full-Flow
P502017	99	Lube Filter, Combination
P502019	96	Lube Filter, Full-Flow
P502020	96	Lube Filter, Full-Flow
P502022	96	Lube Filter, Full-Flow
P502024	96	Lube Filter, Full-Flow
P502032	100	Lube Filter, Combination
P502039	99	Lube Filter, Full-Flow
P502042	101	Lube Filter, Combination
P502043	99	Lube Filter, Combination
P502046	101	Lube Filter, Combination
P502047	96	Lube Filter, Full-Flow
P502048	99	Lube Filter, Full-Flow
P502049	97	Lube Filter, Full-Flow
P502051	97	Lube Filter, Full-Flow
P502056	97	Lube Filter, Full-Flow

Part No.	Page No.	Product Description
P502057	96	Lube Filter, By-Pass
P502058	99	Lube Filter, Combination
P502060	99	Lube Filter, Full-Flow
P502061	99	Lube Filter, Combination
P502062	96	Lube Filter, Full-Flow
P502063	96	Lube Filter, Full-Flow
P502067	96	Lube Filter, Full-Flow
P502068	97	Lube Filter, Combination
P502069	96	Lube Filter, Full-Flow
P502070	96	Lube Filter, Full-Flow
P502072	99	Lube Filter, Full-Flow
P502076	97	Lube Filter, Full-Flow
P502080	99	Lube Filter, Full-Flow
P502081	100	Lube Filter, Full-Flow
P502083	100	Lube Filter, Full-Flow
P502085	100	Lube Filter, Full-Flow
P502088	100	Lube Filter, Full-Flow
P502092	99	Lube Filter, Full-Flow
P502093	101	Lube Filter, Combination
P502107	96	Lube Filter, Full-Flow
P502113	65	Fuel Primary
P502114	66	Fuel Primary
P502115	67	Fuel Primary
P502116	65	Fuel Primary
P502118	66	Fuel Primary
P502131	66	Fuel Primary
P502132	66	Fuel Primary
P502133	65	Fuel Primary
P502134	65	Fuel Primary
P502135	65	Fuel Primary
P502136	67	Fuel Primary
P502138	65	Fuel Primary
P502142	59	Fuel Primary
P502143	59	Fuel Primary
P502149	62	Fuel Primary
P502157	62	Fuel Primary
P502158	62	Fuel Primary
P502161	66	Fuel Primary
P502163	59	Fuel Primary
P502166	65	Fuel Primary
P502167	59	Fuel Primary
P502169	66	Fuel Primary

Part No.	Page No.	Product Description
P502177	59	Fuel Primary
P502179	103	Lube Cartridge, Full-Flow
P502180	103	Lube Cartridge, Full-Flow
P502183	104	Lube Cartridge, Full-Flow
P502184	104	Lube Cartridge, Full-Flow
P502186	105	Lube Cartridge, Full-Flow
P502190	105	Lube Cartridge, Full-Flow
P502191	105	Lube Cartridge, Full-Flow
P502193	102	Lube Cartridge, Full-Flow
P502194	103	Lube Cartridge, Full-Flow
P502196	66	Fuel Primary
P502200	105	Lube Cartridge, Full-Flow
P502202	103	Lube Cartridge, Full-Flow
P502203	103	Lube Cartridge, Full-Flow
P502205	104	Lube Cartridge, Full-Flow
P502206	104	Lube Cartridge, Full-Flow
P502222	101	Lube Filter, Full-Flow
P502223	105	Lube Cartridge, Full-Flow
P502225	103	Lube Cartridge, Full-Flow
P502226	66	Fuel Primary
P502476	99	Lube Filter, Full-Flow
P502503	97	Lube Filter, Full-Flow
P505956	99	Lube Filter, Full-Flow
P505973	65	Fuel Primary
P505978	103	Lube Cartridge
P532921	117	Clamp
P532923	117	Clamp
P532924	117	Clamp
P532925	117	Clamp
P532926	117	Clamp
P532927	117	Clamp
P532928	117	Clamp
P550004	62	Fuel Primary
P550006	98	Lube Filter, Full-Flow
P550007	65	Fuel Primary
P550008	98	Lube Filter, Full-Flow
P550010	104	Lube Cartridge, Full-Flow
P550012	69	Fuel In-Line Filter
P550015	103	Lube Cartridge, Full-Flow
P550016	69	Fuel In-Line Filter
P550017	104	Lube Cartridge, Full-Flow
P550018	104	Lube Cartridge, Full-Flow
P550020	98	Lube Filter, Full-Flow
P550021	105	Lube Cartridge, Full-Flow
P550023	65	Fuel Primary
P550024	98	Lube Filter, Full-Flow
P550025	98	Lube Filter, Full-Flow
P550026	66	Fuel Primary
P550028	66	Fuel Primary
P550032	67	Fuel Sock
P550034	105	Lube Cartridge, Full-Flow
P550035	98	Lube Filter, Full-Flow
P550038	65	Fuel Primary
P550039	65	Fuel Primary
P550040	65	Fuel Primary
P550040	65	Fuel Primary
P550041	105	Lube Cartridge, Full-Flow
P550042	65	Fuel Primary

Part No.	Page No.	Product Description
P550043	66	Fuel Primary
P550044	65	Fuel Primary
P550047	96	Lube Filter, Full-Flow
P550048	62	Fuel Primary
P550049	62	Fuel Primary
P550050	98	Lube Filter, By-Pass
P550051	96	Lube Filter, Full-Flow
P550052	102	Lube Cartridge, Full-Flow
P550054	65	Fuel Primary
P550055	65	Fuel Primary
P550056	65	Fuel Primary
P550057	59	Fuel Primary
P550058	105	Lube Cartridge
P550059	104	Lube Cartridge, Full-Flow
P550060	65	Fuel Primary
P550060	65	Fuel Primary
P550061	65	Fuel Primary
P550061	65	Fuel Primary
P550062	104	Lube Cartridge, Full-Flow
P550065	105	Lube Cartridge, Kit
P550066	105	Lube Cartridge, Full-Flow
P550067	100	Lube Filter, Full-Flow
P550068	104	Lube Cartridge, Full-Flow
P550070	104	Lube Cartridge, Full-Flow
P550071	104	Lube Cartridge, Full-Flow
P550073	101	Lube Filter, Full-Flow
P550074	104	Lube Cartridge
P550076	103	Lube Cartridge
P550077	104	Lube Cartridge, Full-Flow
P550078	97	Lube Filter, Full-Flow
P550080	104	Lube Cartridge, Full-Flow
P550086	100	Lube Filter, Full-Flow
P550087	105	Lube Cartridge, Full-Flow
P550088	61	Fuel/Water Separator
P550090	69	Fuel In-Line Filter
P550091	69	Fuel In-Line Filter
P550092	103	Lube Cartridge, Full-Flow
P550094	69	Fuel In-Line Filter
P550104	49, 61	Fuel Primary
P550105	49, 60	Fuel Primary
P550106	49, 61	Fuel Primary
P550108	61	Fuel Primary
P550109	61	Fuel Primary
P550110	61	Fuel Secondary
P550115	60	Fuel Primary
P550117	104	Lube Cartridge
P550120	66	Fuel Primary
P550125	66	Fuel Primary
P550126	69	Fuel In-Line Filter
P550127	59	Fuel Primary
P550132	104	Lube Cartridge, Full-Flow
P550141	103	Lube Cartridge, Full-Flow
P550147	104	Lube Cartridge, Sock
P550152	100	Lube Filter, Full-Flow
P550154	98	Lube Filter, By-Pass
P550157	102	Lube Filter, Full-Flow
P550162	97	Lube Filter, Full-Flow
P550165	103	Lube Cartridge, Full-Flow

Part No.	Page No.	Product Description
P550166	99	Lube Filter, Full-Flow
P550170	104	Lube Cartridge
P550171	104	Lube Cartridge
P550174	104	Lube Cartridge, Full-Flow
P550179	103	Lube Cartridge
P550181	103	Lube Cartridge
P550183	102	Lube Cartridge, Full-Flow
P550184	102	Lube Cartridge, Full-Flow
P550185	103	Lube Cartridge, Full-Flow
P550186	103	Lube Cartridge
P550188	102	Lube Filter, Full-Flow
P550194	98	Lube Filter, Full-Flow
P550201	66	Fuel Secondary
P550202	54, 64	Fuel Primary
P550203	104	Lube Cartridge, Full-Flow
P550209	69	Fuel In-Line Filter
P550214	65	Fuel Primary
P550215	60	Fuel Primary
P550218	63	Fuel Secondary
P550219	63	Fuel Primary
P550220	103	Lube Cartridge, Full-Flow
P550225	59	Fuel Secondary
P550226	100	Lube Filter, Full-Flow
P550227	97	Lube Filter, Full-Flow
P550242	99	Lube Filter, By-Pass
P550248	38, 59	Fuel/Water Separator
P550249	59	Fuel/Water Separator
P550286	104	Lube Cartridge, Full-Flow
P550287	104	Lube Cartridge
P550299	98	Lube Filter, Full-Flow
P550311	103	Lube Cartridge, Full-Flow
P550315	103	Lube Cartridge, Full-Flow
P550316	66	Fuel/Water Separator
P550317	97	Lube Filter, Full-Flow
P550318	98	Lube Filter, Full-Flow
P550319	100	Lube Filter, Full-Flow
P550325	59	Fuel Primary
P550335	96	Lube Filter, Full-Flow
P550341	102	Lube Filter, Full-Flow
P550342	101	Lube Filter, Full-Flow
P550345	38, 59	Fuel Primary
P550347	66	Fuel Primary
P550348	64	Fuel/Water Separator
P550349	65	Fuel Primary
P550352	67	Fuel/Water Separator
P550357	99	Lube Filter, Full-Flow
P550359	103	Lube Cartridge, Full-Flow
P550361	103	Lube Cartridge, Combination
P550362	97	Lube Filter, Full-Flow
P550364	65	Fuel Primary
P550365	62	Fuel Primary
P550366	66	Fuel/Water Separator
P550368	59	Fuel Primary
P550371	100	Lube Filter, Full-Flow
P550372	62	Fuel Primary
P550378	104	Lube Cartridge, Full-Flow
P550379	104	Lube Cartridge, Full-Flow
P550380	105	Lube Cartridge, Full-Flow

Part No.	Page No.	Product Description
P550381	105	Lube Cartridge
P550382	105	Lube Cartridge
P550383	100	Lube Filter, Full-Flow
P550384	105	Lube Cartridge
P550385	61	Fuel Primary
P550389	97	Lube Filter, Full-Flow
P550390	62	Fuel Primary
P550391	62	Fuel Primary
P550392	65	Fuel Primary
P550393	100	Lube Filter, Full-Flow
P550394	66	Fuel Primary
P550396	102	Lube Cartridge, Full-Flow
P550400	96	Lube Filter, Full-Flow
P550404	67	Fuel Primary
P550405	97	Lube Filter, Full-Flow
P550406	99	Lube Filter, Full-Flow
P550409	99	Lube Filter, Full-Flow
P550410	59	Fuel Primary
P550411	99	Lube Filter, Full-Flow
P550412	99	Lube Filter, By-Pass
P550420	100	Lube Filter, Full-Flow
P550421	101	Lube Filter, Full-Flow
P550422	99	Lube Filter, Full-Flow
P550423	105	Lube Cartridge
P550425	100	Lube Filter, By-Pass
P550428	98	Lube Filter, Full-Flow
P550431	63	Fuel Secondary
P550433	69	Fuel In-Line Filter
P550436	63	Fuel Primary
P550437	65	Fuel Primary
P550437	65	Fuel Primary
P550440	38, 59	Fuel Secondary
P550446	69	Fuel In-Line Filter
P550447	66	Fuel/Water Separator
P550448	63	Fuel Primary
P550451	103	Lube Cartridge
P550453	105	Lube Cartridge
P550454	69	Fuel In-Line Filter
P550460	67	Fuel/Water Separator
P550463	67	Fuel/Water Separator
P550467	67	Fuel/Water Separator
P550472	62	Fuel Primary
P550473	61	Fuel Primary
P550481	65	Fuel Primary
P550484	104	Lube Cartridge, Full-Flow
P550485	105	Lube Cartridge, Full-Flow
P550489	65	Fuel Primary
P550489	65	Fuel Primary
P550490	100	Lube Filter, Full-Flow
P550491	59	Fuel Primary
P550493	105	Lube Cartridge
P550494	62	Fuel Primary
P550495	62	Fuel Primary
P550496	62	Fuel Primary
P550498	59	Fuel/Water Separator
P550500	105	Lube Cartridge
P550501	67	Fuel Primary
P550504	69	Fuel In-Line Filter

Part No.	Page No.	Product Description
P550505	96	Lube Filter, Full-Flow
P550507	98	Lube Filter, Full-Flow
P550508	69	Fuel In-Line Filter
P550510	67	Fuel/Water Separator
P550515	62	Fuel Primary
P550516	105	Lube Cartridge, Full-Flow
P550518	98	Lube Filter, Full-Flow
P550519	100	Lube Filter, Full-Flow
P550520	99	Lube Filter, Full-Flow
P550521	102	Lube Cartridge, Full-Flow
P550522	66	FUEL SOCK
P550526	59	Fuel Primary
P550527	67	Fuel/Water Separator
P550528	103	Lube Cartridge, Full-Flow
P550529	64	Fuel Primary
P550534	96	Lube Filter, Full-Flow
P550540	66	Fuel Secondary
P550541	66	FUEL SOCK
P550547	66	Fuel/Water Separator
P550550	59	Fuel/Water Separator
P550551	98	Lube Filter, By-Pass
P550552	67	FUEL SOCK
P550553	61	Fuel/Water Separator
P550556	70	Fuel In-Line Filter
P550559	65	Fuel Primary
P550560	66	FUEL SOCK
P550562	97	Lube Filter, Full-Flow
P550563	103	Lube Cartridge, Full-Flow
P550564	102	Lube Cartridge, Full-Flow
P550567	66	Fuel Primary
P550580	100	Lube Filter, Full-Flow
P550587	59	Fuel/Water Separator
P550588	38, 59	Fuel/Water Separator
P550593	70	Fuel In-Line Filter
P550595	101	Lube Filter, Combination
P550596	101	Lube Filter, Full-Flow
P550597	101	Lube Filter, Combination
P550598	96	Lube Filter, Full-Flow
P550599	98	Lube Filter, Full-Flow
P550600	97	Lube Filter, Full-Flow
P550607	66	Fuel/Water Separator
P550613	105	Lube Cartridge, Full-Flow
P550614	104	Lube Cartridge
P550625	61	Fuel Primary
P550627	66	Fuel Primary
P550628	67	Fuel Primary
P550629	104	Lube Cartridge
P550630	104	Lube Cartridge, Full-Flow
P550631	67	Fuel Primary
P550632	67	Fuel Primary
P550633	102	Lube Cartridge
P550636	105	Lube Cartridge
P550639	101	Lube Filter, Full-Flow
P550643	62	Fuel Primary
P550645	65	Fuel Primary
P550657	67	Fuel/Water Separator
P550661	104	Lube Cartridge
P550662	62	Fuel Primary

Part No.	Page No.	Product Description
P550665	61	Fuel/Water Separator
P550669	63	Fuel/Water Separator
P550671	95	Lube Filter, Full-Flow
P550671	101	Lube Filter, Full-Flow
P550672	66	Fuel Primary
P550673	66	Fuel Primary
P550678	59	Fuel Primary
P550685	66	Fuel/Water Separator
P550686	66	Fuel/Water Separator
P550688	59	Fuel/Water Separator
P550690	59	Fuel/Water Separator
P550691	61	Fuel/Water Separator
P550707	101	Lube Filter, Full-Flow
P550708	100	Lube Filter, Full-Flow
P550710	97	Lube Filter, Full-Flow
P550711	96	Lube Filter, Full-Flow
P550712	101	Lube Filter, Full-Flow
P550714	100	Lube Filter, Full-Flow
P550715	96	Lube Filter, Full-Flow
P550719	97	Lube Filter, Full-Flow
P550726	97	Lube Filter, Full-Flow
P550729	63	Fuel/Water Separator
P550730	63	Fuel/Water Separator
P550735	61	Fuel Primary
P550736	67	Fuel/Water Separator
P550737	67	Fuel/Water Separator
P550744	102	Lube Cartridge
P550745	65	Fuel Primary
P550746	63	Fuel/Water Separator
P550747	63	Fuel/Water Separator
P550748	63	Fuel/Water Separator
P550750	105	Lube Cartridge
P550751	105	Lube Cartridge
P550752	67	Fuel/Water Separator
P550753	63	Fuel/Water Separator
P550753	63	Fuel Primary
P550757	67	Fuel Primary
P550758	99	Lube Filter, Full-Flow
P550761	103	Lube Cartridge, Full-Flow
P550762	67	Fuel Primary
P550763	103	Lube Cartridge, Full-Flow
P550764	103	Lube Cartridge, Full-Flow
P550765	105	Lube Cartridge, Full-Flow
P550766	103	Lube Cartridge, Full-Flow
P550766	103	Lube Cartridge, Full-Flow
P550767	103	Lube Cartridge, Full-Flow
P550768	103	Lube Cartridge, Full-Flow
P550769	105	Lube Cartridge, Full-Flow
P550774	61	Fuel Primary
P550776	97	Lube Filter, Full-Flow
P550777	91	Lube Filter, By-Pass
P550777	101	Lube Filter, By-Pass
P550779	99	Lube Filter, Full-Flow
P550782	59	Fuel Primary
P550783	59	Fuel Primary
P550785	67	Fuel/Water Separator
P550788	102	Lube Filter, Full-Flow
P550794	96	Lube Filter, Full-Flow

Part No.	Page No.	Product Description
P550797	102	Lube Cartridge
P550798	102	Lube Cartridge
P550800	66	Fuel/Water Separator
P550808	67	FUEL
P550811	63	Fuel Secondary
P550812	104	Lube Cartridge
P550816	103	Lube Cartridge, Full-Flow
P550828	60	Fuel/Water Separator
P550832	98	Lube Filter, Full-Flow
P550847	49, 61	Fuel/Water Separator
P550848	49, 60	Fuel/Water Separator
P550849	67	Fuel/Water Separator
P550851	67	Fuel/Water Separator
P550853	67	Fuel/Water Separator
P550860	65	Fuel Primary
P550861	65	Fuel Primary
P550865	57	W/F Valve for 1/2"-20 UNF Threaded Port Sensor
P550866	116	Coolant Filter, SCA+
P550867	116	Coolant Filter, Non-Chemical
P550868	61	Fuel Primary
P550879	61	Fuel Primary
P550880	62	Fuel Primary
P550881	62	Fuel Primary
P550900	63	Fuel/Water Separator
P550901	49, 60	Fuel/Water Separator
P550908	67	Fuel Primary
P550913	63	Fuel/Water Separator
P550927	103	Lube Cartridge, Full-Flow
P550928	46, 61	Fuel Secondary
P550929	62	Fuel/Water Separator
P550930	62	Fuel/Water Separator
P550931	62	Fuel/Water Separator
P550932	62	Fuel Primary
P550933	99	Lube Filter, Full-Flow
P550934	99	Lube Filter, Full-Flow
P550935	99	Lube Filter, Full-Flow
P550936	60	Fuel Primary
P550937	54, 64	Fuel/Water Separator
P550939	98	Lube Filter, Full-Flow
P550939	98	Lube Filter, Full-Flow
P550939	98	Lube Filter, Full-Flow
P550939	98	Lube Filter, Full-Flow
P550939	98	Lube Filter, Full-Flow
P550941	98	Lube Filter, Full-Flow
P550942	98	Lube Filter, Full-Flow
P550942	98	Lube Filter, Full-Flow
P550943	38, 59	Fuel Primary
P550944	60	Fuel Primary
P550947	95	Lube Filter, Full-Flow
P550947	101	Lube Filter, Full-Flow
P550949	102	Lube Filter, Full-Flow
P550952	104	Lube Cartridge
P550955	68	Fuel Box Primary
P550958	54, 64	Fuel Primary
P550959	56, 64	Fuel Secondary
P550963	98	Lube Filter, Full-Flow
P550964	98	Lube Filter, Full-Flow
P550965	99	Lube Filter, Full-Flow
P550966	65	Fuel/Water Separator

Part No.	Page No.	Product Description
P550966	65	Fuel/Water Separator
P550967	70	Fuel In-Line Filter
P550973	101	Lube Filter, Combination
P550974	70	Fuel In-Line Filter
P550975	99	Lube Filter, Full-Flow
P551000	49, 60	Fuel/Water Separator
P551001	49, 60	Fuel/Water Separator
P551004	49	Fuel Primary
P551005	104	Lube Cartridge
P551010	63	Fuel/Water Separator
P551011	67	Fuel/Water Separator
P551014	104	Lube Cartridge, Full-Flow
P551016	101	Lube Filter, Full-Flow
P551017	97	Lube Filter, Full-Flow
P551018	97	Lube Filter, Full-Flow
P551019	98	Lube Filter, Full-Flow
P551021	64	Fuel Primary
P551025	63	Fuel/Water Separator
P551026	63	Fuel/Water Separator
P551027	63	Fuel/Water Separator
P551028	64	Fuel/Water Separator
P551029	64	Fuel/Water Separator
P551030	63	Fuel/Water Separator
P551031	63	Fuel/Water Separator
P551033	63	Fuel/Water Separator
P551034	63	Fuel/Water Separator
P551034	63	Fuel/Water Separator
P551039	38, 59	Fuel/Water Separator
P551042	98	Lube Filter, Full-Flow
P551049	68	Fuel Box Primary
P551052	67	Fuel/Water Separator
P551055	63	Fuel/Water Separator
P551056	63	Fuel/Water Separator
P551056	63	Fuel/Water Separator
P551057	63	Fuel/Water Separator
P551065	63	Fuel/Water Separator
P551066	63	Fuel/Water Separator
P551067	63	Fuel/Water Separator
P551075	63	Fuel/Water Separator
P551076	63	Fuel/Water Separator
P551077	63	Fuel/Water Separator
P551081	65	Fuel Primary
P551082	65	Fuel Primary
P551086	63	Fuel/Water Separator
P551087	63	Fuel/Water Separator
P551102	100	Lube Filter, Full-Flow
P551103	49, 61	Fuel/Water Separator
P551108	104	Lube Cartridge
P551122	49, 61	Fuel/Water Separator
P551127	61	Fuel Secondary
P551130	68	Fuel Box Primary
P551145	101	Lube Filter, Full-Flow
P551146	101	Lube Filter, Full-Flow
P551162	66	Fuel Primary
P551167	66	Fuel Primary
P551168	66	Fuel Primary
P551178	60	Fuel Primary
P551251	96	Lube Filter, Full-Flow

Part No.	Page No.	Product Description
P551257	100	Lube Filter, Full-Flow
P551262	97	Lube Filter, Full-Flow
P551263	100	Lube Filter, Full-Flow
P551264	100	Lube Filter, Full-Flow
P551265	97	Lube Filter, Full-Flow
P551266	100	Lube Filter, Full-Flow
P551267	100	Lube Filter, Full-Flow
P551277	104	Lube Cartridge
P551279	103	Lube Cartridge, Full-Flow
P551285	103	Lube Cartridge, Full-Flow
P551287	98	Lube Filter, Full-Flow
P551291	102	Lube Cartridge, Full-Flow
P551294	102	Lube Cartridge, Full-Flow
P551296	103	Lube Cartridge, Full-Flow
P551297	97	Lube Filter, Full-Flow
P551307	96	Lube Filter, Full-Flow
P551309	116	Coolant Filter, Non-Chemical
P551310	66	Fuel/Water Separator
P551311	49, 60	Fuel Primary
P551312	61	Fuel Primary
P551313	49, 60	Fuel Primary
P551315	59	Fuel Primary
P551316	64	Fuel Primary
P551317	67	Fuel Primary
P551318	63	Fuel Primary
P551319	49	Fuel Primary
P551329	61	Fuel/Water Separator
P551335	63	Fuel Primary
P551336	105	Lube Cartridge, Full-Flow
P551337	66	Fuel Primary
P551338	65	Fuel Primary
P551339	65	Fuel Primary
P551343	99	Lube Filter, By-Pass
P551344	105	Lube Cartridge
P551345	105	Lube Cartridge
P551348	98	Lube Filter, Full-Flow
P551351	61	Fuel Primary
P551352	98	Lube Filter, Full-Flow
P551381	95	Lube Filter, Full-Flow
P551381	101	Lube Filter, Full-Flow
P551402	102	Lube Filter, Full-Flow
P551421	64	Fuel/Water Separator - Standard Flow
P551422	64	Fuel/Water Separator - Standard Flow
P551423	64	Fuel/Water Separator - Standard Flow
P551424	64	Fuel/Water Separator - Standard Flow
P551425	64	Fuel/Water Separator - Standard Flow
P551426	64	Fuel Primary- Standard Flow
P551427	64	Fuel Primary- Standard Flow
P551428	65	Fuel Primary- Standard Flow
P551429	64	Fuel Primary- Standard Flow
P551430	64	Fuel Primary- Standard Flow
P551431	65	Fuel Primary- Standard Flow
P551432	64	Fuel/Water Separator - Reverse Flow
P551433	65	Fuel/Water Separator

Part No.	Page No.	Product Description
		- Reverse Flow
P551434	64	Fuel Primary - Reverse Flow
P551435	65	Fuel Primary - Reverse Flow
P551436	64	Fuel Primary - Reverse Flow
P551437	64	Fuel Primary - Reverse Flow
P551441	101	Lube Filter, Full-Flow
P551475	104	Lube Cartridge, Full-Flow
P551603	100	Lube Filter, Full-Flow
P551604	100	Lube Filter, Full-Flow
P551605	63	Fuel Primary
P551615	38, 59	Fuel/Water Separator
P551624	66	Fuel Secondary
P551670	95	Lube Filter, Full-Flow
P551670	101	Lube Filter, Full-Flow
P551712	49, 61	Fuel Primary
P551740	59	Fuel Primary
P551744	61	Fuel/Water Separator
P551746	63	Fuel/Water Separator
P551748	66	Fuel Primary
P551751	59	Fuel Primary
P551752	61	Fuel/Water Separator
P551759	70	Fuel In-Line Filter
P551760	70	Fuel In-Line Filter
P551761	104	Lube Cartridge, Full-Flow
P551763	96	Lube Filter, Full-Flow
P551764	98	Lube Filter, Full-Flow
P551767	63	Fuel/Water Separator
P551768	59	Fuel/Water Separator
P551769	65	Fuel Primary
P551770	70	Fuel In-Line Filter
P551771	70	Fuel In-Line Filter
P551772	70	Fuel In-Line Filter
P551781	105	Lube Cartridge
P551783	96	Lube Filter, Full-Flow
P551784	98	Lube Filter, Full-Flow
P551807	100	Lube Filter, Full-Flow
P551808	102	Lube Filter, Full-Flow
P551915	60	Fuel Primary
P552000	67	Fuel/Water Separator
P552006	54, 64	Fuel/Water Separator
P552010	67	Fuel/Water Separator
P552013	66	Fuel/Water Separator
P552014	66	Fuel/Water Separator
P552020	67	Fuel/Water Separator
P552023	66	Fuel/Water Separator
P552024	66	Fuel/Water Separator
P552025	101	Lube Filter, Combination
P552032	49, 60	Fuel/Water Separator
P552040	67	Fuel/Water Separator
P552041	105	Lube Cartridge
P552043	66	Fuel/Water Separator
P552044	66	Fuel/Water Separator
P552050	101	Lube Filter, Full-Flow
P552055	116	Coolant Filter, SCA+
P552070	113	Coolant Filter, SCA+
P552070	116	Coolant Filter, SCA+
P552071	113	Coolant Filter, SCA+
P552071	116	Coolant Filter, SCA+

Part No.	Page No.	Product Description
P552072	113	Coolant Filter, SCA+
P552072	116	Coolant Filter, SCA+
P552073	113	Coolant Filter, SCA+
P552073	116	Coolant Filter, SCA+
P552074	113	Coolant Filter, SCA+
P552074	116	Coolant Filter, SCA+
P552075	113	Coolant Filter, SCA+
P552075	116	Coolant Filter, SCA+
P552076	113	Coolant Filter, SCA+
P552076	116	Coolant Filter, SCA+
P552088	116	Coolant Filter, Time-Release
P552096	116	Coolant Filter, SCA
P552100	101	Lube Filter, Full-Flow
P552106	116	Coolant Filter, SCA
P552200	62	Fuel Secondary
P552203	49, 61	Fuel Primary
P552206	104	Lube Cartridge
P552216	54, 64	Fuel/Water Separator
P552231	104	Lube Cartridge
P552251	49, 60	Fuel Primary
P552253	49, 61	Fuel Primary
P552341	65	Fuel Primary
P552361	102	Lube Cartridge, Full-Flow
P552363	98	Lube Filter, By-Pass
P552366	70	Fuel In-Line Filter
P552370	64	Fuel/Water Separator
P552371	70	Fuel In-Line Filter
P552374	59	Fuel/Water Separator
P552375	103	Lube Cartridge, Sock
P552376	70	Fuel In-Line Filter
P552377	105	Lube Cartridge, Full-Flow
P552378	65	Fuel Primary
P552380	105	Lube Cartridge, Full-Flow
P552382	103	Lube Cartridge, Full-Flow
P552387	68	Fuel Box Primary
P552394	71	Fuel In-Line Filter
P552395	66	Fuel Primary
P552397	71	Fuel In-Line Filter
P552398	71	Fuel In-Line Filter
P552399	71	Fuel In-Line Filter
P552400	71	Fuel In-Line Filter
P552401	71	Fuel In-Line Filter
P552402	103	Lube Cartridge, Full-Flow
P552403	71	Fuel In-Line Filter
P552404	99	Lube Filter, By-Pass
P552405	61	Fuel Primary
P552411	97	Lube Filter, Full-Flow
P552414	105	Lube Cartridge, Sock
P552415	103	Lube Cartridge, Full-Flow
P552419	102	Lube Cartridge, Full-Flow
P552421	102	Lube Cartridge, Full-Flow
P552422	103	Lube Cartridge, Full-Flow
P552423	66	Fuel Primary
P552427	104	Lube Cartridge, Sock
P552428	104	Lube Cartridge, Sock
P552430	96	Lube Filter, Full-Flow
P552432	61	Fuel/Water Separator
P552437	71	Fuel In-Line Filter

Part No.	Page No.	Product Description
P552439	71	Fuel In-Line Filter
P552442	71	Fuel In-Line Filter
P552448	71	Fuel In-Line Filter
P552451	97	Lube Filter, By-Pass
P552455	103	Lube Cartridge, Full-Flow
P552458	103	Lube Cartridge, Full-Flow
P552462	105	Lube Cartridge, Full-Flow
P552464	99	Lube Filter, Full-Flow
P552465	103	Lube Cartridge
P552469	104	Lube Cartridge, Full-Flow
P552470	65	Fuel Primary
P552471	103	Lube Cartridge, Full-Flow
P552473	66	Fuel Primary
P552474	100	Lube Filter, Full-Flow
P552475	64	Fuel/Water Separator
P552482	71	Fuel In-Line Filter
P552518	98	Lube Filter, Full-Flow
P552563	65	Fuel Primary
P552563	65	Fuel Primary
P552564	61	Fuel Primary
P552603	63	Fuel Secondary
P552819	93	Lube Filter, Full-Flow
P552819	97	Lube Filter, Full-Flow
P552849	96	Lube Filter, Full-Flow
P553000	101	Lube Filter, Combination
P553004	38, 59	Fuel Primary
P553080	64	Fuel Primary
P553191	100	Lube Filter, Full-Flow
P553201	49, 60	Fuel/Water Separator
P553202	60	Fuel/Water Separator
P553203	49, 60	Fuel/Water Separator
P553204	49, 60	Fuel/Water Separator
P553205	60	Fuel/Water Separator
P553207	49, 60	Fuel/Water Separator
P553211	49, 60	Fuel/Water Separator
P553212	60	Fuel/Water Separator
P553213	49, 60	Fuel/Water Separator
P553214	49, 60	Fuel/Water Separator
P553215	60	Fuel/Water Separator
P553217	49, 60	Fuel/Water Separator
P553240	59	Fuel Primary
P553261	66	Fuel Secondary
P553315	99	Lube Filter, Full-Flow
P553335	104	Lube Cartridge, Full-Flow
P553375	63	Fuel/Water Separator
P553404	98	Lube Filter, By-Pass
P553411	98	Lube Filter, Full-Flow
P553500	64	Fuel Secondary
P553548	101	Lube Filter, Combination
P553634	102	Lube Filter, Full-Flow
P553693	61	Fuel Secondary
P553712	93	Lube Filter, Full-Flow
P553712	97	Lube Filter, Full-Flow
P553746	100	Lube Filter, By-Pass
P553771	93	Lube Filter, Full-Flow
P553771	97	Lube Filter, Full-Flow
P553854	49, 60	Fuel Primary

Part No.	Page No.	Product Description
P553855	61	Fuel Secondary
P553871	100	Lube Filter, Full-Flow
P553925	105	Lube Cartridge, Full-Flow
P554000	64	Fuel Primary
P554004	100	Lube Filter, Full-Flow
P554005	102	Lube Filter, Full-Flow
P554019	116	Coolant Filter, SCA
P554071	113	Coolant Filter, SCA
P554071	116	Coolant Filter, SCA
P554072	113	Coolant Filter, SCA
P554072	116	Coolant Filter, SCA
P554073	113	Coolant Filter, SCA
P554073	116	Coolant Filter, SCA
P554074	113	Coolant Filter, SCA
P554074	116	Coolant Filter, SCA
P554075	113	Coolant Filter, SCA
P554075	116	Coolant Filter, SCA
P554105	101	Lube Filter, Full-Flow
P554136	105	Lube Cartridge, Full-Flow
P554206	102	Lube Filter, Full-Flow
P554347	60	Fuel Primary
P554403	98	Lube Filter, Full-Flow
P554407	98	Lube Filter, Full-Flow
P554408	96	Lube Filter, Full-Flow
P554422	116	Coolant Filter, SCA
P554470	64	Fuel Primary
P554471	64	Fuel Secondary
P554472	64	Fuel/Water Separator
P554476	64	Fuel Secondary
P554477	64	Fuel/Water Separator
P554560	101	Lube Filter, Full-Flow
P554620	62	Fuel Primary
P554685	113	Coolant Filter, SCA
P554685	116	Coolant Filter, Non-Chemical
P554770	96	Lube Filter, Full-Flow
P554860	116	Coolant Filter, SCA
P554925	104	Lube Cartridge, Full-Flow
P555088	103	Lube Cartridge, Full-Flow
P555095	38, 59	Fuel Primary
P555400	102	Lube Cartridge, Full-Flow
P555522	97	Lube Filter, Full-Flow
P555570	98	Lube Filter, Full-Flow
P555616	93	Lube Filter, Full-Flow
P555616	97	Lube Filter, Full-Flow
P555627	49, 60	Fuel Primary
P555680	93	Lube Filter, Full-Flow
P555680	97	Lube Filter, Full-Flow
P555686	64	Fuel Secondary
P555776	64	Fuel Secondary
P555823	63	Fuel Primary
P556245	66	Fuel Primary
P556285	68	Fuel Box Primary
P556286	68	Fuel/Water Separator Box
P556287	67	Fuel Primary
P556745	68	Fuel Box Primary
P556915	60	Fuel Primary
P556916	46, 61	Fuel Secondary
P556917	46, 61	Fuel Secondary

Part No.	Page No.	Product Description
P557111	66	Fuel Primary
P557207	93	Lube Filter, Full-Flow
P557207	97	Lube Filter, Full-Flow
P557264	68	FFuel/Water Separator Box
P557382	99	Lube Filter, Combination
P557440	49, 60	Fuel Primary
P557500	105	Lube Cartridge, Full-Flow
P557780	98	Lube Filter, Full-Flow
P558000	49, 60	Fuel/Water Separator
P558010	60	Fuel/Water Separator
P558250	93	Lube Filter, Full-Flow
P558250	97	Lube Filter, Full-Flow
P558329	102	Lube Filter, Full-Flow
P558425	105	Lube Cartridge, Full-Flow
P558462	104	Lube Cartridge, Full-Flow
P558600	66	Fuel Primary
P558615	97	Lube Filter, Full-Flow
P558616	97	Lube Filter, Full-Flow
P558712	61	Fuel Primary
P558717	99	Lube Filter, By-Pass
P558792	66	Fuel Primary
P559000	102	Lube Filter, Full-Flow
P559100	61	Fuel Primary
P559108	72	Fuel/Water Separator, Twist&Drain Kit
P559109	72	Fuel/Water Separator, Twist&Drain Kit
P559110	72	Fuel/Water Separator, Twist&Drain Kit
P559111	72	Fuel/Water Separator, Twist&Drain Kit
P559112	72	Fuel/Water Separator, Twist&Drain Kit
P559113	72	Fuel/Water Separator, Twist&Drain Kit
P559114	72	Fuel/Water Separator, Twist&Drain Kit
P559115	72	Fuel/Water Separator, Twist&Drain Kit
P559116	72	Fuel/Water Separator, Twist&Drain Kit
P559117	72	Fuel/Water Separator, Twist&Drain Kit
P559118	72	Fuel/Water Separator, Twist&Drain Kit
P559119	72	Fuel/Water Separator, Twist&Drain Kit
P559121	72	Fuel/Water Separator, Twist&Drain Kit
P559122	72	Fuel/Water Separator, Twist&Drain Kit
P559122	63	Fuel/Water Separator
P559125	63	Fuel Primary
P559126	100	Lube Filter, Full-Flow
P559127	100	Lube Filter, Full-Flow
P559128	100	Lube Filter, Full-Flow
P559129	101	Lube Filter, Full-Flow
P559130	100	Lube Filter, Full-Flow
P559418	93, 97	Lube Filter, Full-Flow
P559624	62	Fuel Primary
P559803	68	Fuel Box Primary
P559850	67	Fuel Primary

Part No.	Page No.	Product Description
P566310	43	Fuel Primary
P566311	43	Fuel Primary
P566312	43	Fuel/Water Separator
P569758	57	Water Collection Bowl
P570349	57	Digital Deutsch WIF Sensor
P570618	57	WIF Valve for Packard Sensor
P570619	57	WIF Valve for Deutsch
P570771	57	Replacement Seals
P572227	57	Digital/AMP WIF Sensor
P574862	104	Lube Cartridge
P574863	103	Lube Cartridge
P765199	64	Fuel Primary
P785373	67	Fuel Primary
P903100	119	Coolant Liquid
P903101	119	Coolant Liquid
P903102	119	Coolant Liquid
P903103	119	Coolant Liquid
P903106	119	Coolant Liquid
P903107	119	Coolant Liquid
P903108	119	Coolant Liquid
P903109	119	Coolant Liquid
P903110	119	Coolant Liquid
P903111	119	Coolant Liquid
P903112	119	Coolant Liquid
P903113	119	Coolant Liquid
P903116	119	Coolant Liquid
P903117	119	Coolant Liquid
P920683	52, 63	Fuel/Water Separator
P920711	52, 63	Fuel/Water Separator
X006136	115	Coolant Additive
X006137	115	Coolant Additive
X006138	115	Coolant Additive
X007036	115	Coolant Additive
X007037	115	Coolant Additive
X007038	115	Coolant Additive
X007099	115	Coolant Additive
X007100	115	Coolant Additive
X007101	115	Coolant Additive
X007102	115	Coolant Additive
X007103	114	Coolant Test Strip Kit
X007374	88	Oil Analysis Kit
X007684	114	Coolant Test Strip Kit
X011407	33	AC Clean Fuel Cart
X011408	33	12-volt DC Clean Fuel Cart
X011431	33	24-volt Clean Fuel Cart
X011448	34	Clean Diesel Kit
X011449	34	Clean Diesel Kit
X011450	34	Clean Diesel Kit

VISIT DONALDSONFILTERS.COM FOR EVEN MORE PRODUCT INFO

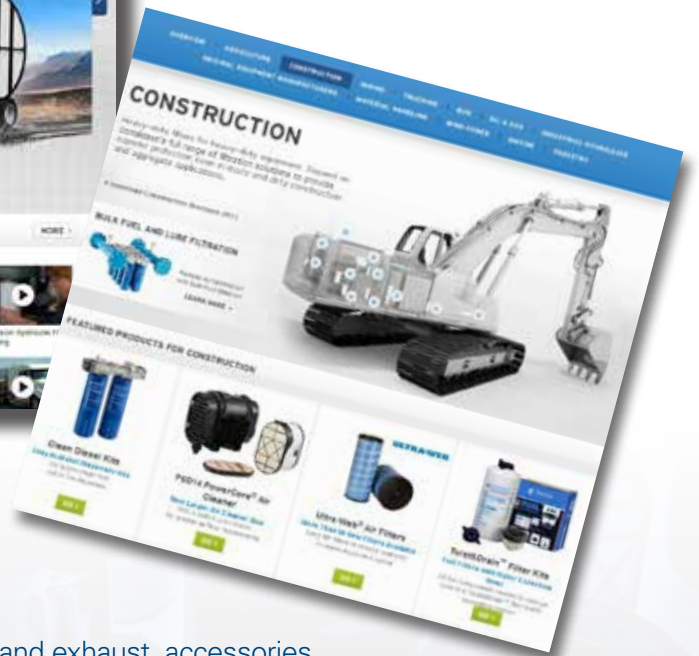
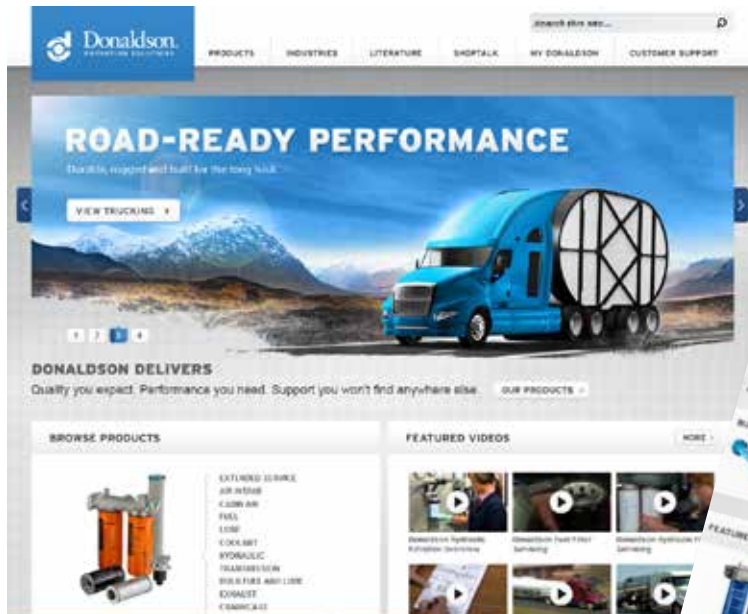

We've made it easier to FIND YOUR FILTER! . . . and exhaust, accessories, air cleaners, hydraulic components and . . . much, much more.

- Every page includes direct links to our most up-to-date, online Cross Reference, Application Search and distributor locator (Where to Buy). Each of these important tools are ONE CLICK AWAY no matter where you go in the site!
- Includes links to **YouTube Service Training videos**.
- PLUS, the website works on your smart phone . . . which we can all agree is a very smart idea!

Be sure to check it out at donaldsonfilters.com!



SERVICE TRAINING VIDEOS



youtube.com/user/donaldsonengine

Global Presence with a Local Touch

At Donaldson, we've built a strong, flexible and responsive distribution network to serve our customers around the world.

Localized Manufacturing – It starts with 30+ manufacturing locations around the world – producing most filters in the regions where they're used.

Primary Distribution Centers – Filters then move to our regional warehouses and distribution center hubs – meaning the filters you need are never far away.

Logistics – We work with a network of transportation and logistics companies, consolidators and cross-docking facilities to deliver products to distribution partners quickly and efficiently.

Distribution Partners – We've built one of the largest, strongest and most responsive distributor networks in the filter industry – meaning you can find the filters and support you need, nearly anywhere in the world.



DONALDSON APPLICATION SEARCH



appsearch.donaldson.com

AMERICAS AND SOUTH AFRICA CROSS REFERENCE



crossreference.donaldson.com

EUROPE & ASIA PACIFIC CROSS REFERENCE



b2b.emea.donaldson.com/public/engine/prd/inqxref.htm

AUSTRALIA CROSS REFERENCE



donaldsontoolbox.com.au



Donaldson Company, Inc.
Minneapolis, MN USA

www.buydonaldson.com
www.donaldsonfilters.com
www.donaldson.com

North America 800-374-1374
Mexico, Latin America & Caribbean 52-449-910-6150
Brazil 55-11-2119-1604
Europe 32-16-38-3811

South Africa 27-11-997-6000
South East Asia 65-6311-7373
Greater China 852-2405-8388
Japan 81-42-540-4112
Korea 82-2-517-3333
Australia 61-02-4350-2033
India 91-124-4807-400

Catalog No. F110024 ENG (8/14)

© 2014 Donaldson Company, Inc. All rights reserved. Donaldson Company, Inc. reserves the right to change or discontinue any model or specification at any time and without notice. Printed in the U.S.A.